

# Wireless World

RADIO AND ELECTRONICS

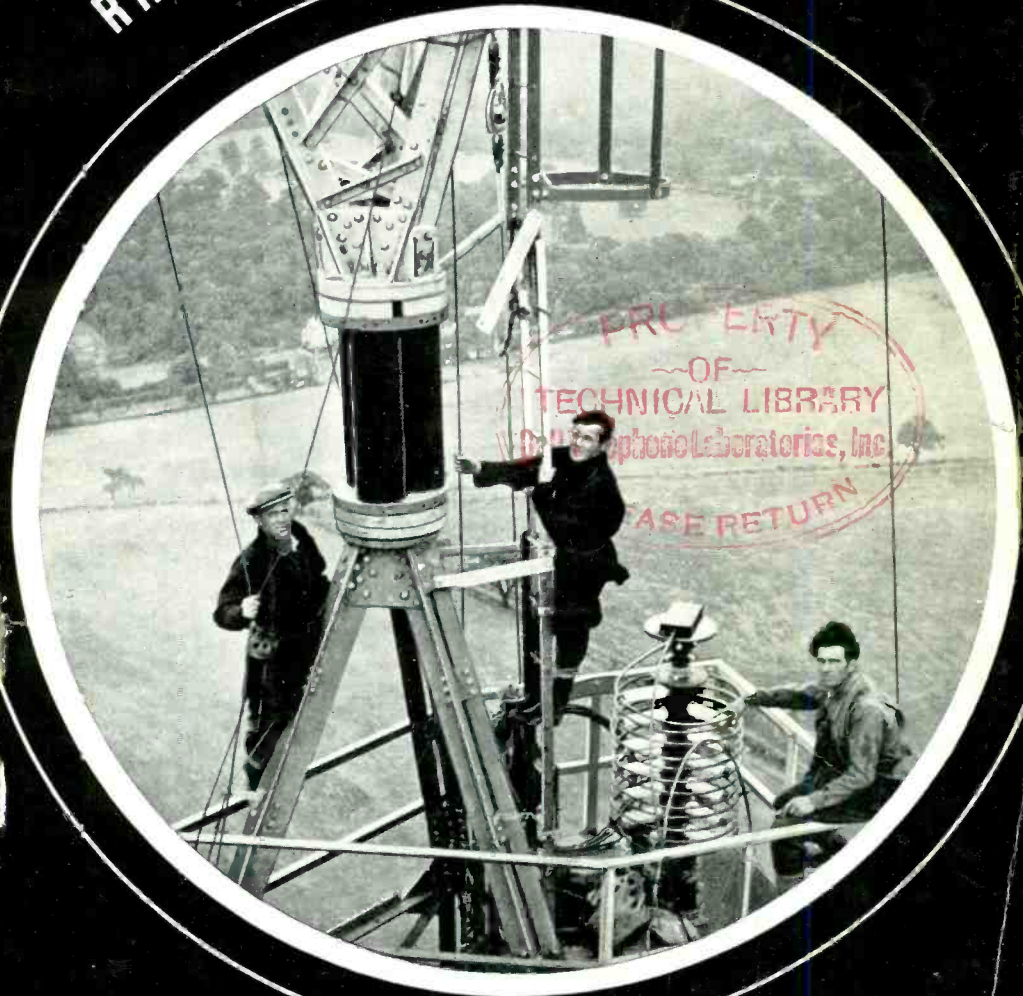

DEC. 1946

1/6

Vol. LII. No. 12

IN THIS  
ISSUE :

POST-WAR TELEVISION SET : First Test Report

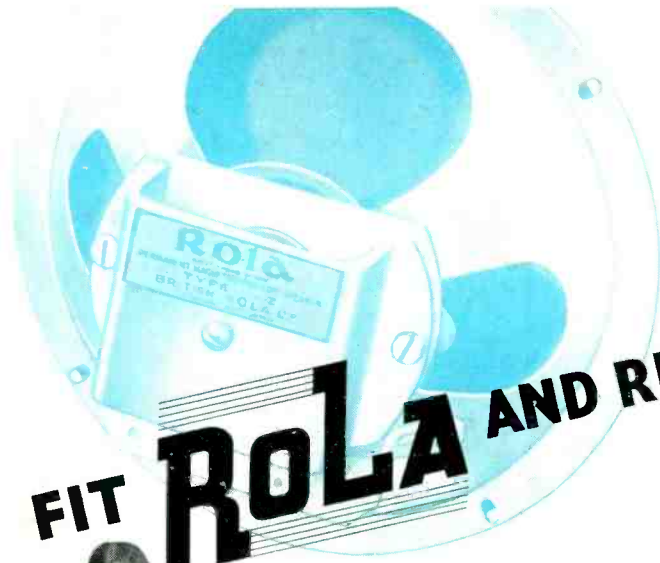

A radio receiver is judged by the quality of its reproduction more than by any other single factor. That is why the speaker is such a vital part of any set. No wonder so many Planning Engineers decide on Rola speakers for all their models. They know they can fit Rola and relax!

**ROLA SPEAKERS**  
**THEIR QUALITY SPEAKS FOR ITSELF**

BRITISH ROLA LTD • GEORGIAN HOUSE • BURY ST • ST JAMES'S • LONDON. S.W.1

BRITISH MADE  
*Large* MULTIPLE WINDING MACHINES

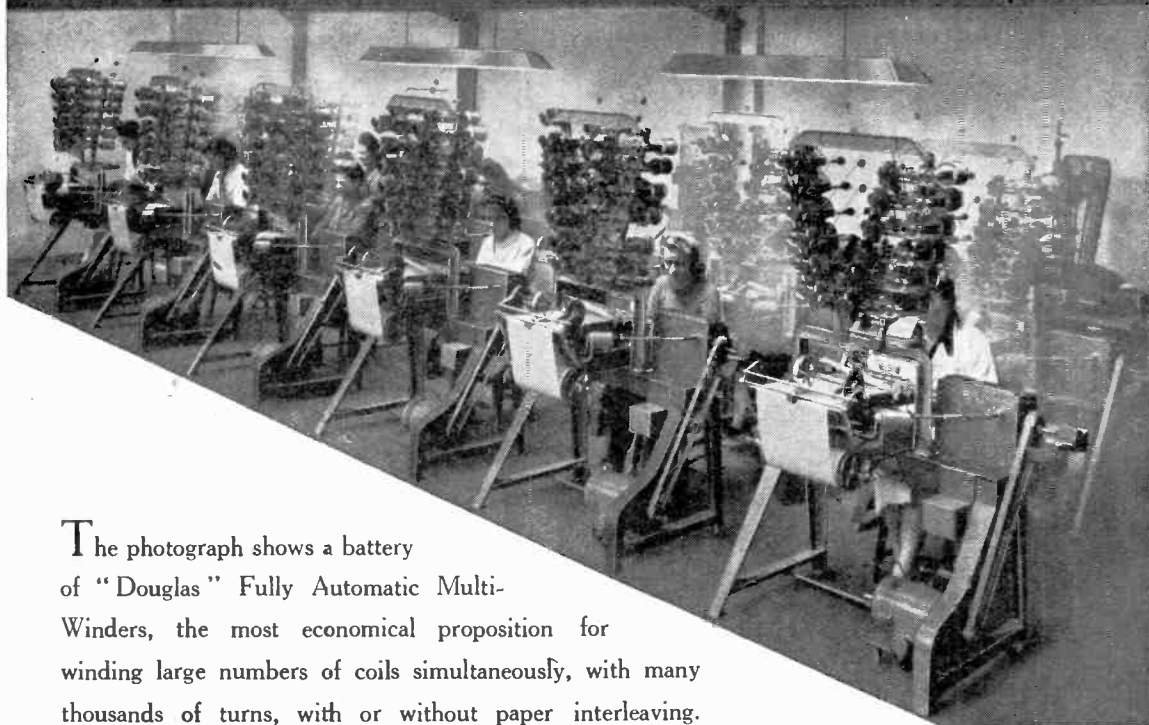

The photograph shows a battery of "Douglas" Fully Automatic Multi-Winders, the most economical proposition for winding large numbers of coils simultaneously, with many thousands of turns, with or without paper interleaving.

This machine winds coils from  $\frac{1}{2}$ -inch to 6 inches in length, and from  $\frac{3}{8}$ -inch to  $4\frac{1}{2}$  inches in diameter, the maximum width of paper being 12 inches. Up to as many as 12 coils can be wound simultaneously.

The paper interleaving is fully automatic and has a constant overlap. The machine will stop automatically at a predetermined number of turns.

Fully descriptive leaflet on application.

Manufactured by :

**THE AUTOMATIC COIL WINDER &  
 ELECTRICAL EQUIPMENT CO. LTD.**  
 WINDER HOUSE, DOUGLAS STREET, LONDON, S.W.1.

Telephone : VICTORIA 3404-9

Running Speed :  
 Variable from 500 to 3,000 R.P.M.

Wire Gauges :  
 47 S.W.G. to 30 S.W.G.

Dimensions of machine :  
 53 × 39 × 53 inches.

Nett Weight : 446 lbs.

# The **GOODMANS** *Loudspeaker*

..... for more than twenty years has been distinguished by sound design, fine quality of materials employed, and advanced technical efficiency.

The 15 in. model provides a typical example. With an excellent response up to 6,000 c.p.s. and an inherent freedom from peaks and dips, it sets a new standard in units for Dance Halls, Rinks, and Heavy duty P.A. installations.



This illustration shows the comparative sizes of a Goodmans 15 in. and 12 in. loudspeaker. You already know the performance of the famous 12 in. Now consider the technical data of the 15 in. model.

Fundamental Resonance	...	55 c.p.s.
Voice Coil Diam.	...	2 in.
Voice Coil Imped.	...	3.5 ohms at 400 c.p.s.
Flux Density	...	15,000 gauss
Max. Power Capacity	...	25 W. peak A.C.
Net Weight	...	28 lb. 6 oz.
TYPE	...	T2/1205/15

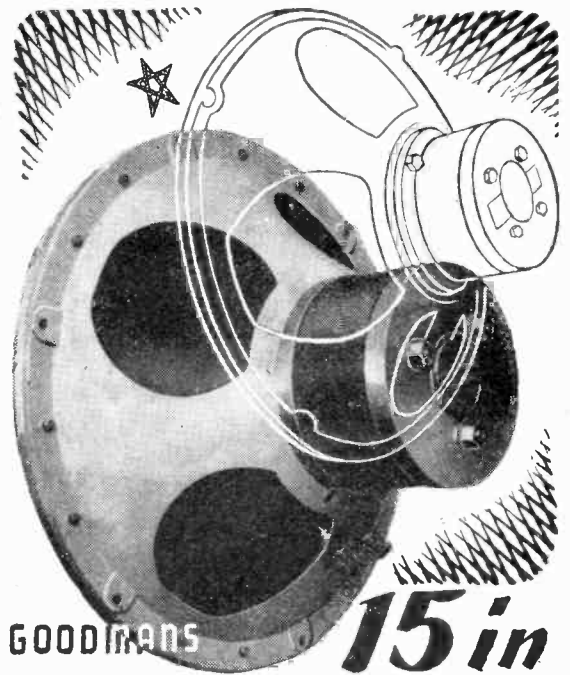

GOODMANS INDUSTRIES LTD · L'ANCELOT RD · WEMBLEY · MIDDX

# TAYLOR *for the Best* *in Test Equipment*

MODEL  
**65B**



## ALL WAVE SIGNAL GENERATOR

1. Six wavebands cover from 100 kc/s to 46 mc/s.
2. Scale directly calibrated in frequency.
3. R.F. output controlled by coarse and fine attenuators.
4. 400 c/s internal oscillator provides 30 per cent modulation if required.
5. Unmodulated or externally modulated R.F. output available.
6. Up to 1 volt output of 400 c/s available for Audio tests.
7. Main filters are fitted reducing direct radiation to a minimum.
8. Operates from 110 or 200-250 volts A.C. mains, 40-100 cycles.
9. Dimensions: 12½ in. x 8½ in. x 6 in. deep. Weight about 10 lbs.

Taylor Model 65B is a reliable and accurate mains-operated portable Signal Generator. It is designed for all general Radio frequency and Audio frequency tests on Radio receivers or amplifiers.

Price **£15.10.0**

Please write for technical brochure.

# Taylor Electrical Instruments Ltd.

419-424 MONTROSE AVENUE, SLOUGH, BUCKINGHAMSHIRE  
Tel: Slough 21381 (4 lines) Grams: "Taylins" Slough

# METALLISED CERAMICS

There's a size for every job  
in the S.P. range of  
metallised  
bushes

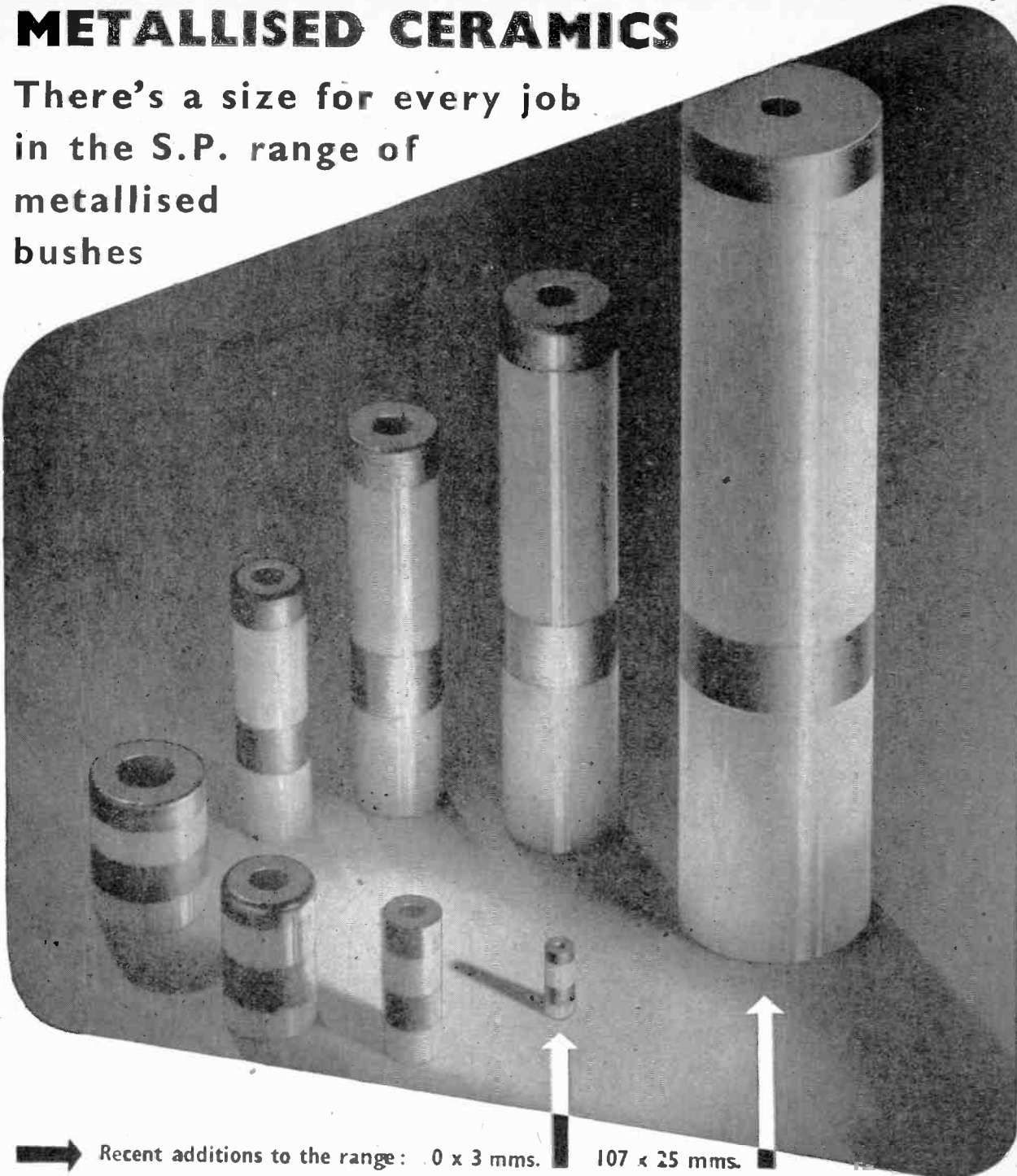

➔ Recent additions to the range: 0 x 3 mms. 107 x 25 mms.

For full information and prices please write to :

## STEATITE & PORCELAIN PRODUCTS LTD.

Stourport on Severn, Worcs. Telephone : Stourport III. Telegrams : Steatoin, Stourport.



S.P.44



# A handsome collection—

Whether you are a keen DX Chaser or a serious experimenter—or both, you'll be interested in the collection of up-to-the minute gear at Webb's. Our staff, which includes six active "transmitters," will be happy to put at your disposal the experience they have gained with the latest gear and to help you decide what is best suited to your particular requirements.

Here are a few of the interesting items available:—

### RADIO FEEDERS

Webb's 600 ohms feeder, something new. Ready built-in lengths of 50 and 35 feet. Spacing  $3\frac{1}{2}$ " with 18 gauge wire. Polythene spreaders securely moulded into wire every 20 inches, light and rigid construction. Supplied on drums ready for winding off, and immediate use.

Per 50 foot drum £1 17 6 } Packing and despatch  
Per 35 foot drum £1 6 3 } 2/6 extra.

Co-axial Cable, impedance 80 ohms, outside diameter 7/16" any length supplied. Polythene internal insulation, weatherproof rubber outer covering.

Per yard ..... 1s. 6d.

Special—Ten yard lengths of 7/16" 80 ohms co-axial as above fitted at both ends with co-axial plugs and sockets. (Supplied only in ten yard lengths). Per length with plugs and sockets ..... 15s. 0d.

### HOOK-UP WIRE

22 gauge tinned copper, covered P.V.C. Clean new wire, readily stripped. (Note, covering is non-flam. and does not melt from heat). In nine colours, ideal for circuit-coding.

Per 10 yd. Coil ..... 1s. 8d.

### THERMO-COUPLE METERS

Radio Frequency 2" Pattern Flush Mounting meters by leading makers. Second-hand, but all tested and guaranteed. Two types available, 0.5 amp. and 2.0 amps. (Note, limited stocks only). Price ..... £1 4 0 each.

### EDDYSTONE MANUAL

The No. 5 edition of this interesting book now available. Constructional articles on 4 Valve "All Dry" Receiver, Frequency Meter, U.H.F. Converter, Pre-Selector, Transmitters, etc. .... 2s. 6d.

Supplies limited, regret CALLERS ONLY for this book.

# Webb's RADIO

14 SOHO ST., OXFORD ST., LONDON, W.1.

Phone : GERrard 2089. Shop hours : 9 a.m.—5.30 p.m. Sats. 9 a.m.—1 p.m.

# Steady as a Rock!

VITAVOX MICROPHONE STANDS have been designed, not only to look attractive in all surroundings, but to do the all-important job of holding that microphone "steady as a rock." Built, as usual with all our products, in traditional VITAVOX quality. Obtainable from your usual Vitavox wholesaler. If any difficulty is experienced, please write direct to us.

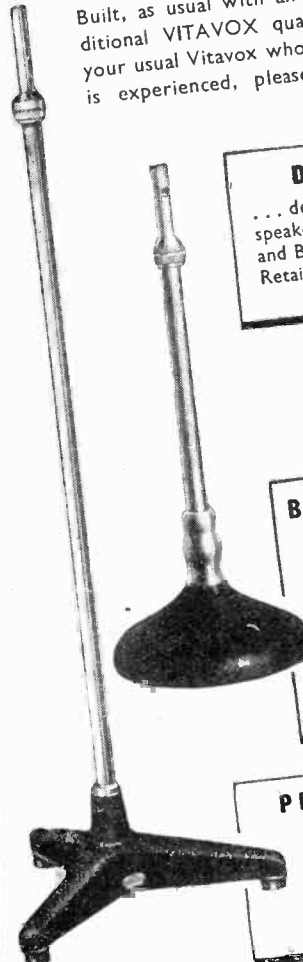

### DESK MODEL

... designed for use when the speaker is seated. Finish—Black and Bronze Crackle. Retail price ..... £1 1s. 0d.

### BANQUET MODEL

... designed for occasions when the speaker is to stand at a table. Extension 17-24 ins. Finish—Black and Chrome Bronze, or Florentine Bronze. Retail price ... £2 15s. 0d.

### PEDESTAL MODEL

... dignified floor stand extending from 4-7 ft. Cable through stand. Finished as Banquet Model. Retail price .... £4 5s. 0d.

# VITAVOX

## MICROPHONE STANDS

VITAVOX LIMITED  
WESTMORELAND ROAD, LONDON, N.W.9  
Telephone - Colindale 8671

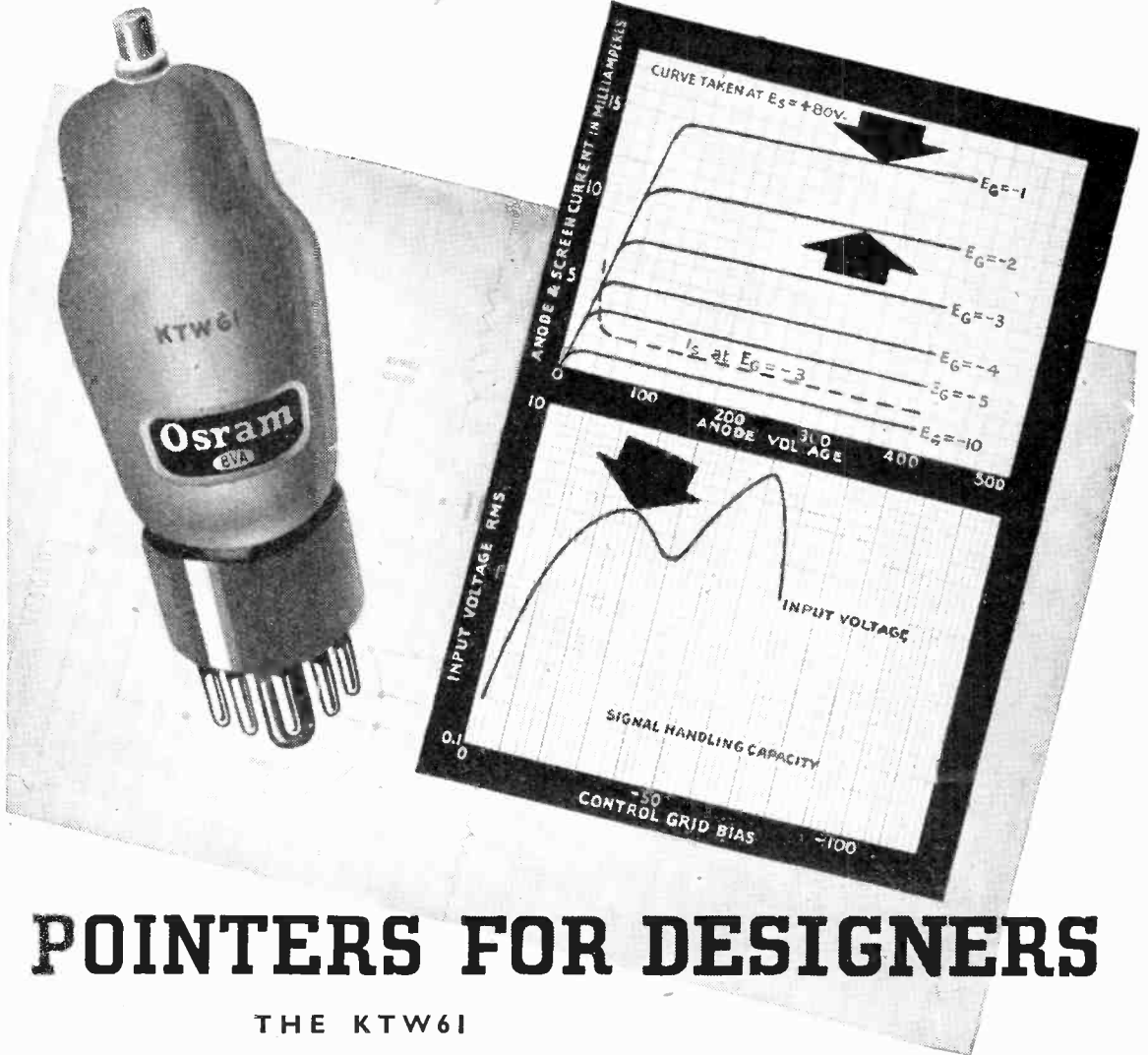

# POINTERS FOR DESIGNERS

## THE KTW61

A screened tetrode with suppressor plates and with variable-mu characteristics, the OSRAM KTW61 is specially suitable for use as an R.F. or I.F. amplifier in superhet receivers. Its outstanding features include:—

- High order of mutual conductance (2.9 mA/Volt) combined with low leakage capacitance (0.0025  $\mu\mu\text{F}$ ), which facilitates high stage gain.
- Negligible distortion with the maximum signal likely to be encountered in practice. Conditions of use — as an I.F. amplifier with screen dropping resistance, and in conjunction with OSRAM frequency changer X61M.
- Marked improvement in signal to noise ratio, particularly on the short waves, when used as an R.F. amplifier with fixed screen voltage.

A detailed technical data sheet is available on request.

**Osram**  
PHOTO CELLS

**G.E.C.**  
CATHODE RAY TUBES

**Osram**  
VALVES

MARCONI INSTRUMENTS LTD  
Specialists in  
Measurement for Communications  
can now offer their

## OUTPUT POWER METER TYPE TF 340

**FOR IMMEDIATE DELIVERY**

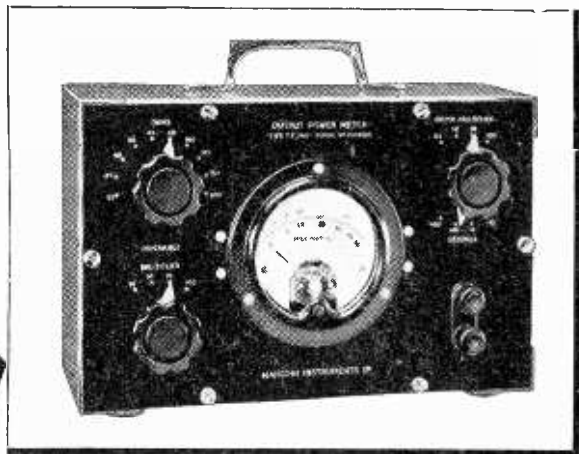

The instrument indicates directly the power delivered by an audio-frequency system into a variable external load provided by the Meter

itself. Its technical efficiency is in the highest Marconi tradition. Full technical information available on request.



## MARCONI INSTRUMENTS LTD

ST. ALBANS, HERTS.

Phone: ST. ALBANS 4323/6

Northern Office: 30 ALBION STREET, HULL. Phone: Hull 16144

Western Office: 10 PORTVIEW ROAD, AVONMOUTH. Phone: Avonmouth 438 Southern Office: 109 EATON SQUARE, LONDON, S.W.1. Phone: Sloane 861's

# WESTINGHOUSE WESTALITE H.T. RECTIFIERS

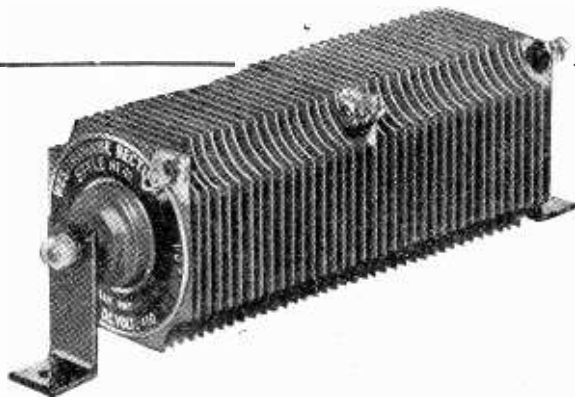

**FOR**

- A.C. Eliminators and Receivers.
- A.C./D.C. Eliminators and Receivers.
- Conversion of D.C. Battery Eliminators.
- Conversion of D.C. Mains Receivers.
- Operation of moving-coil loud-speakers.

Write to Dept. W.W. for Data Sheet No. 24.

WESTINGHOUSE BRAKE & SIGNAL CO., LTD., 82, York Way, King's Cross, London, N.1





# DECCA NAVIGATOR TOWERS

*Built by*



The aerial towers for the Decca Navigator transmitter were designed and constructed by B. I. Callender's. These galvanized steel lattice-type structures, 325 feet high, insulated from earth and carrying four 75 feet long flexible horizontal booms to support vertical antennæ wires, are examples of the kind of work on radio masts and towers which we undertake in all parts of the World.

**BRITISH INSULATED CALLENDER'S CABLES, LIMITED**  
NORFOLK HOUSE, NORFOLK STREET, LONDON W.C.2.

THE  
**COSSOR**  
 HIGH VACUUM  
**DOUBLE BEAM**  
**OSCILLOGRAPH**

*giving*

VISUAL TWO-DIMENSIONAL  
 delineation of any recurrent law.



RELATIVE TIMING OF EVENTS  
 and other comparative measurements  
 with extreme accuracy.



PHOTOGRAPHIC RECORDING  
 of transient phenomena

*and*

**SIMULTANEOUS INDICATION**  
 of two variables on a common time axis.

Completely embracing all the above functions, of which the last is unique, the Cossor Double Beam Oscillograph is inherently applicable to all problems arising in

RECORDING, INDICATING & MONITORING  
 when the effects examined can be made available as a voltage.

**A. C. COSSOR LTD.,**  
**INSTRUMENT DEPT.,**  
 Highbury, London, N.5

Phone: CA Nonbury 1234 (30 lines)  
 Grams: Amplifiers, Phone, London

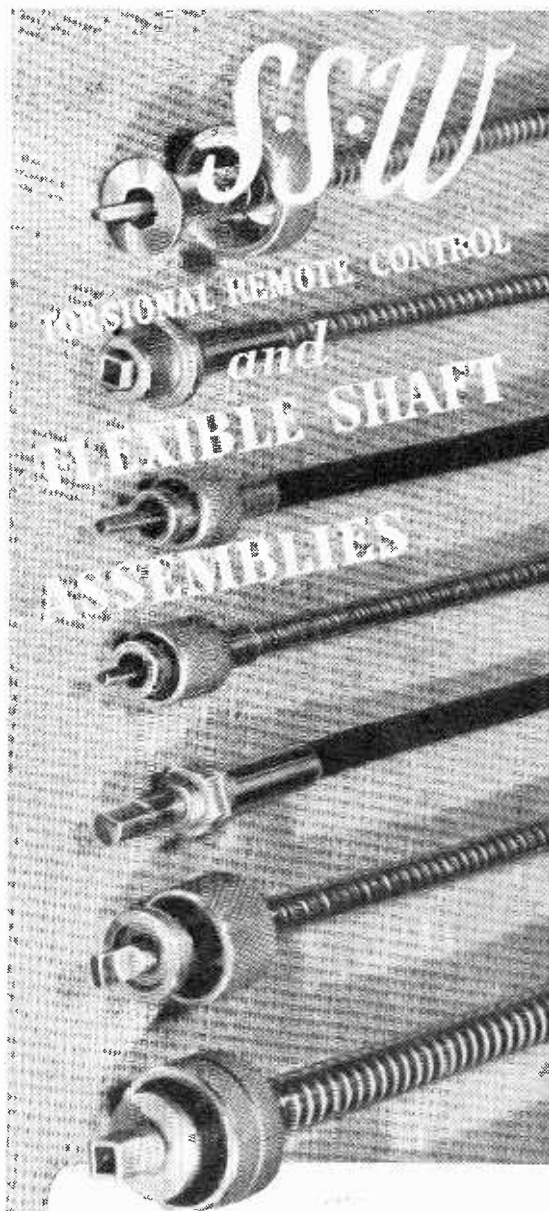

DEFLECTIONLESS SLOW SPEED OPERATION  
 ... car radio

POWER SHAFTS FOR HIGH SPEED OPERATION  
 ... speedometers ... tachometers

PUSH-PULL OPERATION  
 ... chokes ... starters

TENSION OPERATION ... brakes

THE S. S. WHITE COMPANY BRITANNIA WORKS  
 ST. PANCRAS WAY · CAMDEN TOWN LONDON N.W.1.  
 Cable Address: WHICODENTA, WESDO, PHONE, LONDON  
 Telephone: EUSTON 4758-4759

Robert Sharp & Partners

WT 32



## THE STANDARD OF TECHNICAL EXCELLENCE QUALITY AND RELIABILITY

Dubilier Capacitors have been known and selected by Radio Engineers since the early days of radio. The development and extension of their range during the years has proceeded step by step with, and often in anticipation of, the progress of radio and electronics. The result is that today Dubilier Capacitors cover, with the highest degree of efficiency, the entire field in which Capacitors are used.

With the rapid growth of scientific knowledge during the past few years, important internal improvements have been effected in the Dubilier range of Capacitors. Many of these improvements are not always apparent until the Capacitors are actually in use, but their excellent performance gives final proof of the essential quality of these improvements.

MAKERS OF THE WORLD'S  
FINEST CAPACITORS

# DUBILIER

CONDENSER CO. (1925) LTD.

DUBILIER CONDENSER CO. (1925) LTD., DUCON WORKS, VICTORIA ROAD, NORTH ACTON, W.3  
Phone: Acorn 2241 Grams: Hivoltcon, Phone, London. Cables: Hivoltcon, London. Marconi International Code.

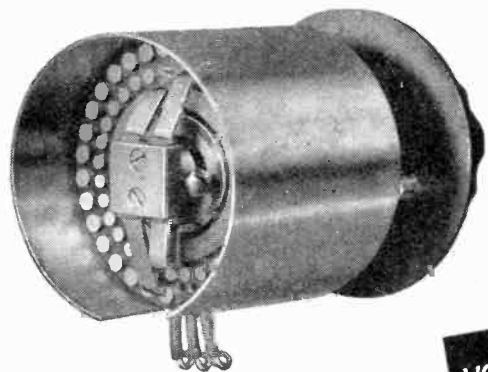

... another famous production from

*The House of*

**VOICE FREQUENCY FADERS,  
LOW FREQUENCY AND HIGH  
FREQUENCY ATTENUATORS**

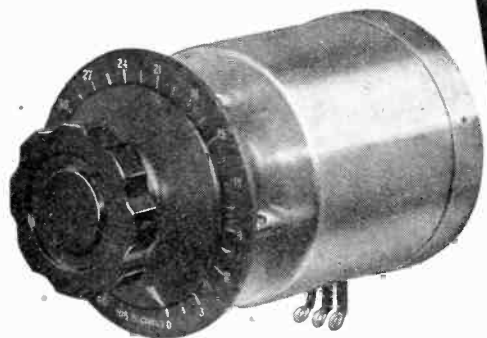

We shall be happy to supply the fullest information.



PAINTON & COMPANY LIMITED  
KINGSTHORPE NORTHAMPTON  
Telephone: Northampton 2820

# Wharfedale

Public Address

## LOUD SPEAKER

### W.12

Now fitted with

### TICONAL MAGNET



13,000 LINES FLUX DENSITY

**Price 135/-**

Die Cast Non-resonant Chassis with accurate rear suspension. Impedance, 15 ohms. Diameter, 12". Weight, 11½ lbs. Peak input, 15 watts.

## WHARFEDALE WIRELESS WORKS

**BRADFORD ROAD, IDLE, BRADFORD**

Telephone: Idle 461.

'Grams: Wharfedel, Idle, Bradford.

# PREMIER RADIO COMPANY

MORRIS & CO. (RADIO) LTD.

ALL POST ORDERS to 167 LOWER CLAPTON RD., LONDON, E.5. 'Phone: Amherst 4723  
ALL CALLERS to 169 FLEET STREET, LONDON, E.C.4. 'Phone: Central 2833

Send 2½d. stamp for our September, 1946 list

Terms of Business: Cash with order or C.O.D. over £1

ITEMS MARKED WITH AN ASTERISK CAN BE SUPPLIED IN QUANTITY FOR TRADE OR EXPORT. PLEASE STATE QUANTITY REQUIRED WHEN MAKING AN ENQUIRY

**MIDGET RADIO KIT.** Build your own Midget Radio. A complete set of parts, including valves, loudspeaker and instructions. In fact, everything except cabinet necessary to build 4-valve Medium and Long Wave T.R.F. Radio operating on 200-557 v. Mains A/C or D/C. Valve line-up, 6K7, 6J7, 25A6, 25Y5. Wavelengths covered 200-557 and 700-2,000. Size 10 x 6 x 6in. Completely drilled chassis. Price, including tax, £8 17s. 6d.

An attractive bakelite cabinet can be supplied at 25/- extra.

**SUPERHET MIDGET RADIO KIT.** A complete kit of parts for a 5-valve superhet. Covers 16-60 and 200-557 metres. AC/DC 200-250 v. 6K8, 6K7, 6J7, 25A6, 25Y5. Size 10 x 6 x 6in. Completely drilled chassis. Price, including tax, £8 5s.

An attractive bakelite cabinet can be supplied at 25/- extra.

**COMMUNICATION RECEIVER KIT.** We can accept orders for January delivery of our new 8-valve kit. Valve line-up 6K7, R.F. amp. 6K8 Frequency Changer, 6K7 B.P.O., 6K7 1st I.F. amp., 6K7, 2nd I.F. amp. 6Q7 det. 6V6 output, 5Z4 rect. covers 13-40, 38-120, 200-557 metres, complete with drilled chassis. Crackle finish steel cabinet, speaker, valves, etc. Price, including tax, £18 18s.

A 6-volt battery and a AC/DC version will be available shortly.

**PREMIER MAINS TRANSFORMERS.** All primaries tapped 210-220-250 v. All LT's centre tapped. All have screened primaries.

Output	Price
175-0-175 v. 50 m/a. 6.3 v. 2-3 a. 5 v. 2 a. ....	25/-
175-0-175 v. 50 m/a. 4 v. 1 a. 4 v. 2-3 a. ....	25/-
250-0-250 v. 60 m/a. 6.3 v. 2-3 a. 5 v. 2 a. ....	25/-
250-0-250 v. 60 m/a. 4 v. 1-2 a. 4 v. 3-5 a. ....	25/-
300-0-300 v. 60 m/a. 4 v. 2-3 a. 4 v. 3-5 a. 4 v. 1-2 a. ....	25/-
350-0-350 v. 100 m/a. 5 v. 2-3 a. 6.3 v. 2-3 a. ....	29/-
350-0-350 v. 100 m/a. 4 v. 2-3 a. 4 v. 2-3 a. 4 v. 3-5 a. ....	29/-
350-0-350 v. 150 m/a. 4 v. 1-2 a. 4 v. 2-3 a. 4 v. 3-6 a. ....	36/-
350-0-350 v. 150 m/a. 4 v. 2-3 a. 4 v. 2-3 a. 4 v. 1-2 a. ....	39/-
350-0-350 v. 150 m/a. 5 v. 2-3 a. 6.3 v. 2-3 a. 6.3 v. ....	36/-
425-0-425 v. 200 m/a. 4 v. 2-3 a. 4 v. 2-3 a. 4 v. 3-6 a. ....	47/-
425-0-425 v. 200 m/a. 6.3 v. 2-3 a. 6.3 v. 3-5 a. 5 v. ....	47/-
500-0-500 v. 150 m/a. 4 v. 2-3 a. 4 v. 2-3 a. 4 v. 2-3 a. ....	47/-
4 v. 2-3 a. 4 v. 3-5 a. ....	47/-
500-0-500 v. 150 m/a. 5 v. 2-3 a. 6.3 v. 2-3 a. 6.3 v. ....	50/-
3-5 a. ....	50/-
500-0-500 v. 250 m/a. 5 v. 2-3 a. 6.3 v. 2-3 a. 6.3 v. ....	65/-
3-6 a. ....	28/-
300-0-300 v. 120 m/a. 5 v. 2-3 a. 6.3 v. 3-4 a. ....	28/-
300-0-300 v. 120 m/a. 4 v. 2-3 a. 4 v. 2-3 a. 4 v. 3-5 a. ....	28/-
375-0-375 v. 250 m/a. 6.3 v. 2-3 a. 6.3 v. 3-5 a. 5 v. ....	38/-
375-0-375 v. 250 m/a. 4 v. 2-3 a. 4 v. 2-3 a. 4 v. 3-6 a. ....	46/-
750-0-750 v. 250 m/a. ....	67/6
1,000-0-1,000 v. 200 m/a. ....	70/-

### LOUDSPEAKERS

Trans.	Make	Diam.	Capa.	Voice	Price
Nil	Rola	5 1/2 in.	2w.	2-5 P.M.	21/6
Nil	Rola	6 1/2 in.	3w.	2-3 P.M.	22/6
Nil	Rola	8 in.	4w.	2-3 P.M.	24/-
Pentode	Rola	6 1/2 in.	3w.	2-3 ohms	35/-
Nil	Grampian	9 in.	6w.	1-5 P.M.	38/-
Pentode	E.A.	10 in.	5w.	2-3 P.M.	45/-
Nil	Celestion	10 in.	8w.	4-5 2100 ohms	50/-
Nil	Goodmans	12 in.	15w.	15 P.M.	£6/15/-
Nil	Vitavox	12 in.	12w.	15 P.M.	£7
Nil	Vitavox	12 in.	20w.	15 P.M.	£11

**MIDGET SHORT VARIABLES.** Super quality, ceramic insulation. 10 pf. 20 pf. 50 pf. 75 pf. 100 pf. Any of above types 3/6 each. \* Also available in 2 gang. 6.4 pf., 9 pf., 18.9 pf., 27.2 pf. Any of above type 8/6. Also 44 pf. 75 pf., 10/6.\*

### TUBULAR ALUMINIUM CAN, WIRE END, OIL FILLED CONDENSERS

Capacity	Working Voltage	Size	Price Each	Per Doz.
.01	1,000	1 1/4 x 1 in.	9d.	7/6
.02 mf.	750	1 1/4 x 1 in.	9d.	7/6
.1 mf.	500	1 1/4 x 1 in.	9d.	7/6
.25 mf.	350	2 x 1 in.	9d.	7/6
.5 mf.	350	2 1/4 x 1 in.	9d.	7/6

## RADIOGRAM CABINETS

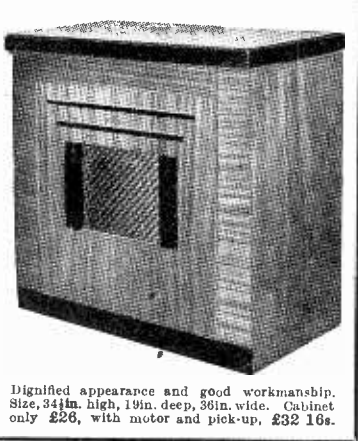

Dignified appearance and good workmanship. Size, 34 1/2 in. high, 19 in. deep, 36 in. wide. Cabinet only £26, with motor and pick-up, £32 16s.

### BATTERY CHARGER KITS.

- All incorporate metal rectifiers, input 200-250 v. AC. 40/100 cycles.
- To charge 2 v. accumulator at 1 amp. .... Price 15/-
- To charge 6 v. accumulator at 1 amp. .... 17/6
- To charge 12 v. accumulator at 1 amp. .... 22/6
- To charge 6 or 12 v. accumulator at 4 amps. .... 23/15/-
- Complete with variable resistance and meter £3/15/-
- To charge 6 or 12 v. accumulator at 6 amps. .... £5/-

### AUTO TRANSFORMERS.

- 110 v. to 200/250 v. Step up or down. 20 watt, 15/-; 60 watt, 21/-; 125 watt, 27/6; 250 watt, 37/6; 500 watt, 65/-; 2 kw., £6/-
- COMPLETE 1-VALVE LISTENING POST.** Consists of 1-valve Receiver completely wired with coils covering 12-170 and 255-550 m. Valves, Headphones, Dry Batteries, Aerial Wire. Nothing else to buy. £3/17/6.
- WIRE-WOUND POTENTIOMETERS.** Any value between 20 and 100,000 ohms 3 watt, 5/9.
- FULL VISION S/M DRIVES.** Calibrated 16-47, 200-557 and 700-2,000 with station names; 8-1 Eusecthon size, 7 1/2 in. x 4 in., 10/6.
- 200-557 and 700-2,000 and junior model, calibrated size, 5 in. x 4 in., 8-1, 10/6.
- EPICYCLOID DRIVES.** 8-1 reduction, 2/9.
- UTILITY MICRODIAL.** Communication type. Slow and fast motion dual knob and silver engraved, 4 in. circular dial with hairline cursor 100-1 reduction. Fits entirely on front of panel, 10/6.
- MAINS DROPPER RESISTANCES.** Variable type, with sliding adjustment, 800 ohms, .3 amp., 5/6; 1,000 ohms, 2 amp., 5/6.
- 2-VALVE, SHORT-WAVE BATTERY KIT.** A complete kit of parts for a 2-valve receiver, covering 15-600 metres, including valves, coils, drilled chassis, H.T. and L.T. dry batteries to last approximately 6 to 12 months. A pair of double headphones and full instructions. Price £3 10s.\* An extra coil can be supplied, covering 600-1,300 metres at 4/-.
- B.F.L. SIGNAL GENERATOR.** 100 kc/s. to 30 mc/s. Mains operated. £21.\* Send for descriptive leaflet.
- MOVING IRON METERS.** Flush mounting, 2 in. diameter, available for D/C only in the following ranges: 10, 25, 50, 100, 250 and 500 m/a, 1, 2, 3, 5 and 10 amps. 10/6 each.
- FERRANTI MOVING COIL METERS.** 2 1/2 in. diameter flush mounting, calibrated 0-500 microamps. 21/-.\*
- 5-WATT AC/DC AMPLIFIER.** For use as gramophone pick-up amplifier. Push/pull, excellent quality. £8 8s.\*
- MIDGET MOVING COIL UNITS.** 1 in. diameter, 50 ohm voice coil, 8/6. Matching transformer for same, 5/-.
- Please state whether L/8 output or Microphone type required.
- ALUMINIUM CHASSIS.** Substantially made of bright aluminium, with four sides.
 

7 x 3 x 2 1/2 in.	4/6	9 1/4 x 4 1/2 in.	5/6
10 x 8 x 2 1/2 in.	7/-	10 x 9 x 2 1/2 in.	7/9
14 x 9 x 2 1/2 in.	8/3	16 x 8 x 2 1/2 in.	8/6
20 x 8 x 2 1/2 in.	10/6	22 x 10 x 2 1/2 in.	13/6*

### MANSBRIDGE TYPE CONDENSERS.

Huge purchase of Military Surplus Paper Condensers. Super quality, oil filled.

Capacity	Working Voltage	Size	Price Each	Per Doz.
2 mf.	1,000	4 1/2 x 1 1/2 x 1	2/6	20/-
2 mf.	500	3 1/2 x 1 1/2 x 1	1/3	10/-
1 mf.	600	2 1/2 x 1 1/2 x 1	1/3	8/-

**PREMIER PLAYING DESK.** A high-grade electric Gramophone Motor with 12 in. turntable. Mounted on a strong metal frame. 100 to 300-250 volts A/C 40/60 cycles. Size 15 x 14 x 2 1/2 in., £5 7s. 6d.

**GRAMOPHONE PICK-UPS.**  
Bosherel Senior Crystal Pick-up, £2 16s. 3d.  
Cosmocord Crystal Pick-up, £1 17s.  
Goldring Magnetic Pick-up, £1 10s. 6d.

**OUTPUT TRANSFORMERS.** A super production. By means of ingenious series-parallel arrangements, all windings are used at all times. Match any tube, single or push-pull to any voice coil 2-30 ohms. 7 watts, 22/6; 15 watt, 30/-; 30 watt, 49/6; 60 watt, 59/6.

### ENAMELLED COPPER WIRE

16g	18g	20g	22g	24g	26g	28g
1/11 3/8	1/11 3/8	2/- 3/9	2/2 3/10	2/2 3/10	2/5 4/2	2/6 4/2
32g	32g	34g	36g	38g	43g	43g
8 oz.	8 oz.	2/10	3/1	3/1	3/7	4/2
16 oz.	16 oz.	4/8	5/6	6/4	12/6	12/6

**TYPE 103. Rotary Transformer.** Normal rating is 19 v. D/C input. Output 300 volts 20 m/a and 6.5 volts 3 a. D/C. By applying between 300 and 250 volts 110 v. to the 11/7 output side, the two low-tension windings may be used to charge accumulators. The 19-volt side will charge a 6-volt accumulator at 2-3 amps, the 6.5 side a 2-volt accumulator at 1-2 a. With a 12-volt input to the 19-volt side, 180 v. at 30 m/a and 4 v. at 3 a. may be obtained. With a 6-volt input to the 6.5 side, 160 v. at 30 m/a may be obtained. By extending the spindle which is flush with the frame and applying 200 to 250 v. 110 v. D/C mains to the 300 v. side, the unit becomes a powerful high-speed electric motor, suitable for small drilling machines, etc. Similarly, it may be used with 6 or 12 v. input to the 6.5 v. or 19 v. side. It employs a powerful ring magnet and is of substantial construction costing originally over £5. A fortunate purchase enables us to offer these fine units at 10/-.

**TYPE 110.** A compact unit consisting of a Rotary Transformer contained in a strong steel case, with complete smoothing. Input 12 v. D/C. Output 200 v. 30 m/a. With 6 v. input output is 110 v. 15 m/a, 30/- each.

**TYPE No. 111.** A Rotary Transformer designed for an input of 6 or 12 v. D/C. With 6 v. input the output is 200 v. 50 m/a. With 12 v. input the output is 480 v. 40 m/a. These ratings are continuous. This unit may be run for up to 3 hours with 12 v. input when 80 m/a may be drawn at 400 v. 20/-.

**TYPE 101.** A 1/2 h.p. motor coupled on a bedplate to a 250-watt generator. Input 12 or 24 v. D/C. Output 850 or 1,700 v. 150 m/a. Complete with starter. £6\*. Motor only available at £4 10s.\*

**TYPE 106.** A Rotary Transformer with extremely efficient smoothing, contained in a steel case. Input 12 v. D/C. Output 240 v. 100 m/a, £3 10s.

**TYPE 113.** A Rotary Transformer input 6 or 12 volts. With 12 v. input, output is 600 v. 250 m/a, with 6 v. input, output is 300 v. 200 m/a. £3\*.

**TYPE 114.** Input 6 v. D/C, output 230 v. 50 cycles A/C 30 w., 45/-.

**TYPE 115.** Input 6, 12 or 24 v. Output 200, 500 or 1,200 v. 72 m/a, 40/-.

**KIT OF PARTS FOR H.T. ELIMINATOR AND TRICKLE CHARGER.** Output 150 v. 30 m/a 2 v. half amp. Metal Rectification. Amazing value, at 30/-.

**CO-AXIAL CABLE.** Super quality, consisting of a stranded centre core, a low-loss ribbed polyvinyl resin tube insulator, a flexible screen, a weatherproof P.V.C. outer cover. Just the thing for Television Lead-in or Super Mike Cable, 6d. per foot.

**B.P.L. UNIVERSAL TEST METERS.** Army type in shockproof bakelite case, 10, 100, 500 volts, A/C and D/C at 1,000 op. v. 10, 100, 500 m/a, D/C, 6-10,000 ohms, with self-contained battery, £8 16s. Current Transformer for same, 1, 1 and 10 a. A/C, 39/6\*.

# RUBBER-TO-METAL BONDING

The Problem of Insulating delicate instrument panels from vibration and shock by means of Flexilant Mountings

**"FLEXILANT" Mountings: Examples from the SERIES.**

The "Flexilant" Mounting of which several varieties are illustrated here is so accurately made that its displacement under load can be calculated to within .010" of requirements. The series is designed to carry loads of from 1 to 45 lbs. per mounting and these may be arranged with bolt axis at 90° to position, or the complete mounting may be inverted. The mountings can be supplied with or without holder and they can be arranged so that two utilize the same bolt.

We should appreciate the opportunity of helping with your vibration problems.

**RUBBER BONDERS Ltd.**  
*Engineers in Rubber bonded to metal*

**FLEXILANT WORKS** • WATLING STREET • DUNSTABLE, BEDS.  
TELEPHONE: DUNSTABLE 803  
TELEGRAMS: FLEXILANT, DUNSTABLE

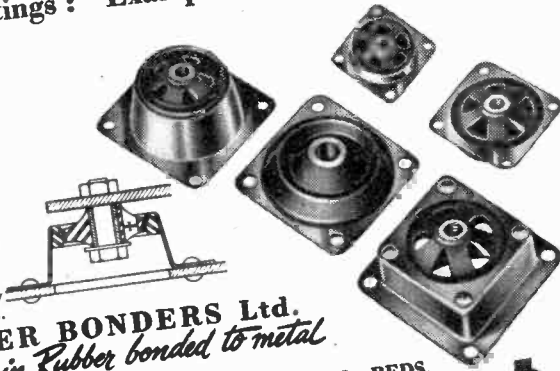

R.312



## FOR THE RADIO SERVICEMAN DEALER AND OWNER

The man who enrolls for an I.C.S. Radio Course learns radio thoroughly, completely, practically. When he earns his Diploma, he will KNOW radio. We are not content merely to teach the principles of radio, we want to show our students how to apply that training in practical, every-day radio service work. We train them to be successful!

Write to the I.C.S. Advisory Dept. stating your requirements. Our advice is free and places you under no obligation.

-----You may use this Coupon-----

**INTERNATIONAL CORRESPONDENCE SCHOOLS Ltd.**

DEPT. 39, INTERNATIONAL BUILDINGS, KINGSWAY, LONDON, W.C.2

Please explain fully about your instruction in the subject marked X

Complete Radio Engineering      Radio Service Engineering  
Elementary Radio

And the following Radio Examinations:—

British Institution of Radio Engineers.  
P.M.G. Certificates for Wireless Operators.  
City and Guilds Telecommunications.  
Wireless Operator and Wireless Mechanic, R.A.F.

Name..... Age.....

Address.....

Here at last!  
**A REAL GEM**

KILLICK'S  
*Sapphox*  
**REPRODUCING INSTRUMENT**  
PR. PATENT NO. 2,8214/45

REDUCES SURFACE NOISE

PRESERVES THE LIFE OF THE RECORD

DOES AWAY WITH NEEDLE CHANGING

STRAIGHT LINE REPRODUCTION FROM 78 TO 1,000rpm

This scientifically designed "Patent Sapphox" Instrument cannot touch the bottom of the groove, thus leaving it undamaged.

**KILLICK & COMPANY, 118 FLEET STREET, E.C.4**  
Telephone: CENTRAL 3807  
Manufacturers of Amplifiers, Radiograms, Scientific Recording Instruments, Cutting Stylus, Discs, Playback Sapphires, etc.

*Sound Specialties*

W.W.1

FOR RADIO

# LONDON CENTRAL RADIO STORES

BARGAINS

*A New Delivery!*

## EX-R.A.F. R155 COMMUNICATION RECEIVERS

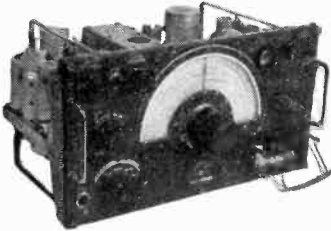

These sets are equal to new, need only a power pack for immediate use (see "W.W." July, 1946). Freq. range, 7.5 mcs. to 1,500 kcs., complete with 10 valves, including magic eye. Enclosed in strong metal box. Each receiver is aerial tested. **15 Gns.**

**POWER PACK 220-250 v. AC for above is available to CALLERS ONLY.**

**EX-GOVT. WIRELESS REMOTE CONTROL UNIT** comprising: Morse key, magneto for ringing bell, warning light, relay, etc., in steel case with carrying strap size, 12in. x 6in. x 6in. Few only **19/6**

## EX-ARMY REFLECTOR TYPE P.M. LOUDSPEAKERS

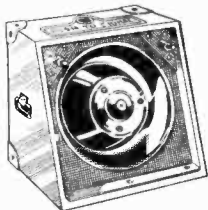

By Tannoy and Truvox. Suitable for small P.A. work, factories, etc. A robust job in heavy wooden case, 9in. x 9in. x 7in. Bargain price

**£2. 17. 6**

**EX-G.P.O. RELAYS**, multi-contact resistance of bobbin 750, 5,000 or 7,000 ohms. **5/-** each

*Special Purchase!*

## PORTABLE RECEIVERS Type 21 Mk. 1

**Ex-Govt. Short Wave with Power Pack**

A.C. Input, 100-250 v. Freq. range, 3-8 mcs., R.T. or C.W. Receiver is a super-het (iron core I.F.s), using EF39 (RF), ECH35 (FO), EF39(1F), EB33(DDT). Complete with special lightweight headphones (120Ω). Aerial and earth wire. Receiver enclosed in metal box, 6in. x 7in. x 9in. Power pack, 3in. x 6in. x 5in. The complete outfit is housed in a wood-lined, fibre attaché case, size 14in. x 10in. x 7in. **5 Gns.** Circuit and full operating instructions enclosed

## PORTABLE UNIVERSAL AMPLIFIERS

200-250 volt input, 5 valves, P-pull output. 6-8 watts in Rexine covered carrying case. Complete with mike and floor stand, loudspeaker, etc., size when open closed 13in. x 15in. x 10in. Bargain offer **£19.10.0**

## EX-GOVT. TELEPHONE HANDSETS



Self-energising, need no battery or excitation. **35/-** With wall bracket. Per pair handsets.....

## MULTI-RANGE TEST METERS



**Moving Coil**  
New First-grade army type in bakelite case. Ranges: 10, 50, 100 and 500 volts at 1,000 ohms per volt A.C. and D.C. 1, 10, 100 and 500 mA and 0-10,000 ohms .... **£8.15.0**

## TO CALLERS

We have a varied selection of Meters, Microphones, Amplifiers, Radar and Ex-Government Radio and Electrical equipment.

*Only a Few Available!*

## EX-ARMY No. 58 Mk. 1 TRANS-RECEIVER

Self-contained 8 v. Short Wave



**Trans-Receiver Chassis**

Frequency Range 6-9 mc/s with Rod Aerials, Panel Test Meter, 8 Valves, Wire, etc. .... **£7**

OR Complete with 8 spare valves, spare vibrator and fuses, 2 non-spill accumulators, 2 noise limiting Mikes, 2 pr. Headphones, cables and Vibrator H.T. power supply **£15**

**SMALL FRACTIONAL H.P. MOTORS**, 24v. D.C.A.G. Universal and Reversible. Weight 20 ozs. Size 2 1/2 x 2 1/2 x 2in. .... **19/6**

**D.C. MICROAMMETER**, central zero 0-100. 4in. Dial panel mounting. **£3.0.0**

**MOVING COIL MICROPHONE INSERTS** DC res. 30 ohms. .... **5/-** each

**SINGLE ALUMINIUM TUNING CONDENSERS**, Cap. .00045. 1in. spindle **4/6**

**12 VOLT VIBRATORS**, 4 pin UX base. **9/6** New

## EX-GOVT. HIGH SPEED RELAY

with platinum contacts, D.C. resistance of coil 500 ohms., enclosed in dustproof brass box, size 3in. x 1 1/2in. x 1in. **6/6** New

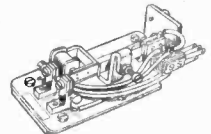

**HAND MICROPHONES**, Ex-Govt. By Tannoy and Truvox. Heavy-duty multicarbon type, heavy metal case, with on/off switch in handle. .... **£1.0.0**

**P.M. LOUDSPEAKERS**. New 8in. with output transformer **27/6**

**LONDON CENTRAL RADIO STORES, 23, LISLE ST. (GERrard 2969), LONDON, W.C.2**

## ERG'S HAVE THE URGE TO GO ABROAD

**SPEAKING EXPORTLY...**

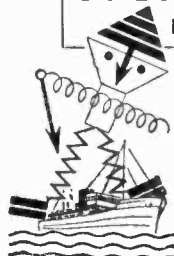

ERG Resistors have an exceptional electrical specification and performance, with mechanical strength.

High-grade Vitreous Enamels used on our Tropical Resistors give long life, and definitely assist in the trouble-free manufacture and performance of Radio Receivers, Television and Test Equipment.

ERG Resistors are processed up to the highest Service Standards at a competitive Price.



**ERG INDUSTRIAL CORPORATION LTD.**  
SALES OFFICE · 10 PORTMAN SQUARE, LONDON, W.1 TELE.: WELBECK 8114/5

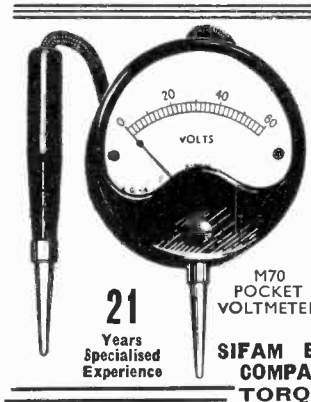

# SIFAM POCKET PRECISION

MODERN ROBUST CONSTRUCTION AND CONSTANT ACCURACY UNDER ALL CONDITIONS

**21** Years Specialised Experience

**M70 POCKET VOLTMETER**

**SIFAM ELECTRICAL INSTRUMENT COMPANY LIMITED**  
**TORQUAY - DEVON**

OUR FIRST POST-WAR PRODUCT  
THE ROMAC 106  
"Personal" RECEIVER

£14 14 0 Complete, Plus P.T. £3 6 0

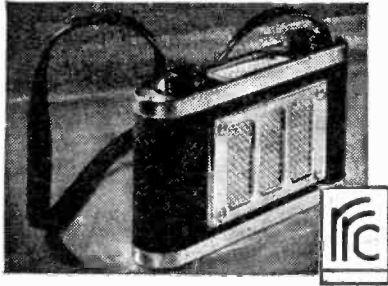

This Receiver has been selected as an Exhibit at the "BRITAIN CAN MAKE IT" Exhibition.

Home and Export enquiries should be directed to:

**ROMAC RADIO CORPN. LTD.**  
THE HYDE · HENDON · LONDON, N.W.9.

NOW IN PRODUCTION

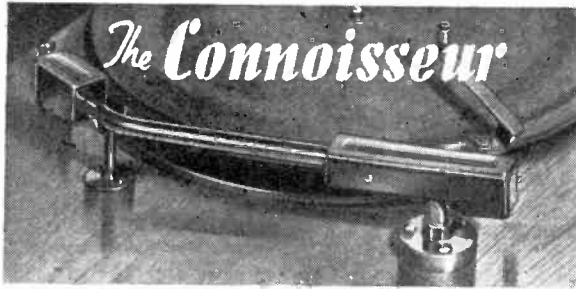

- ★ Artistically designed — scientifically developed.
- ★ Light in weight—small in size.
- ★ Constant Velocity type, response from 30 C.P.S. to 12,000 C.P.S. without objectionable resonances.
- ★ Weight of pick-up on to record 30 grams, armature and needle weight .090 grams.
- ★ When used on high fidelity reproducing equipment the realism is amazing.

Please send your enquiries to The Albion Electric Stores,  
125, Albion Street, Leeds

MADE BY  
**A. R. SUGDEN & CO. (ENGINEERS) LTD.**  
BRIGHOUSE YORKSHIRE

# Sound Understanding

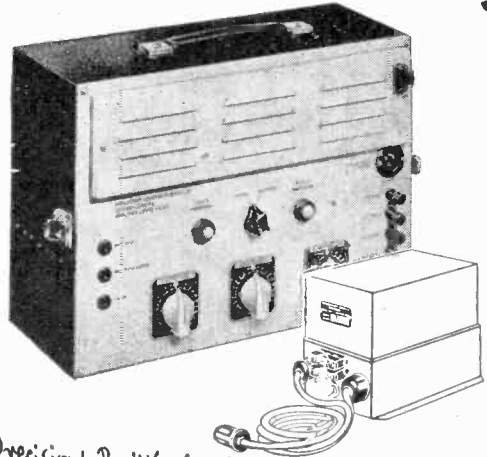

Precision Built for Perfect Reproduction

A Portable Amplifier capable of providing an undistorted output of 20 watts. Separate volume control for microphone and pickup. AC Mains or from 12 volt accumulator, used with the B.S.R. Vibrator Power Unit VP 60.A.

**BIRMINGHAM SOUND REPRODUCERS LTD.**  
CLAREMONT WORKS  
OLD HILL STAFFS.

# BSR

M-W.55

**5 mmf/ft.**

NEW LOW LEVELS in capacity and attenuation of CO-AX Cables mean new possibilities in electronic equipment design both for the war effort and for the post-war electronic age.

Write for characteristics

**BASICALLY BETTER  
AIR-SPACED**

**CO-AX LOW LOSS CABLES**  
**TRANSRADIO LTD. 16 THE HIGHWAY BEACONSFIELD 4-BUCKS.**



# U.I.C. Metallised Ceramics

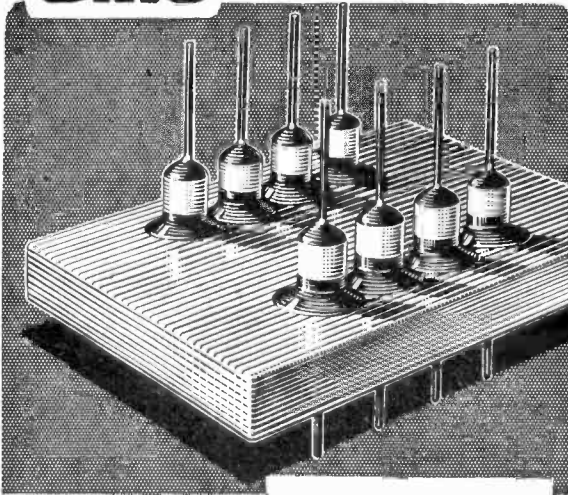

We specialise in the production of all types of Metallised Ceramic components — Hermetic Seals, Sealed Lids, Tag Boards, Bushes, Formers, etc. These are available in soldered, coppered or silvered finish, according to requirements. The suitability of any finish is a matter which we shall be pleased to discuss.

**HERMETIC SEAL  
TYPE HS 421**

Flashover Voltage over outside path. 4.5 KVDC at 20° C.  
Flashover Voltage over inside path 3.5 KVDC at 20° C.  
Small size. Close assembly. Physically robust.

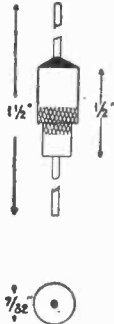

Components made to standard design or to customers' specific requirements. Write for details.

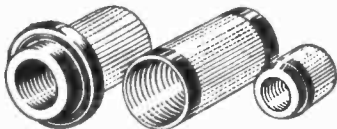

**UNITED INSULATOR CO. LTD**  
Oakcroft Rd., Tolworth, Surbiton, Surrey

Telephone: Elmbridge 5241 Telegrams: Calanel, Surbiton

*Unsurpassed In Ceramics*

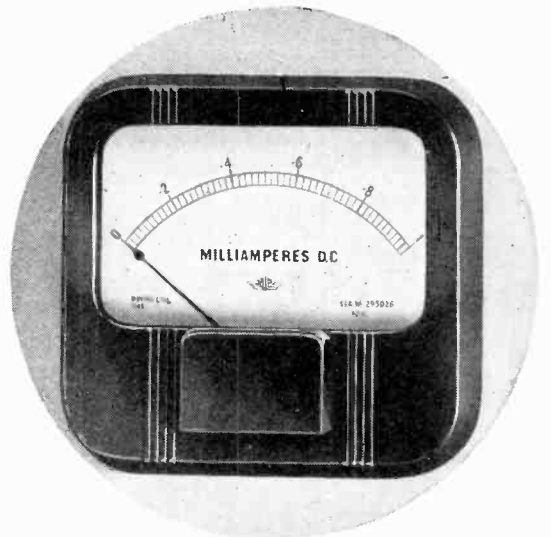

## PULLIN SERIES 35 ILLUMINATED DIAL RECTANGULAR INSTRUMENTS

THE Pullin illuminated dial fitment gives even illumination over the whole scale. Being external it cannot cause heating of the movement. It is housed in a metal box on the front cover and can be easily inspected or replaced without the use of tools. The box acts as a reflector and its design and position enhances the appearance of the instrument. The lamp is a 6 V. 3 watt tubular festoon type. The terminals are at the back of the instrument case.

These instruments are available in a wide range of moving coil types to meet every requirement. Full details upon application.



Please address all correspondence to: Dept. J., Phoenix Works  
Great West Road, Brentford, Middlesex. Ealing 0011

## M.R. SUPPLIES Ltd.

give immediate delivery from stock of the following high-class and brand new **RADIO AND ELECTRICAL MATERIAL**. All prices nett.

**CURRENT FED MICROPHONES**, by prominent maker. Require no amplifier. Feed directly into 15-ohms speaker via associated transformer, in conjunction with 12-volt battery. Ideal for intercom, alarm and calling systems, etc. Hand type, with transformer. **£4/10/-**.

**MOVING COIL MICROPHONES**, special limited offer of Reslo Senior model on resilient mount, very fine response. 15-ohms coil, 5/16th inch mount. **£4/10/-** (5/16th inch to 4 inch adaptors, 1/6).

**ROTHERMEL PIEZO-CRYSTAL MICROPHONES** (exclusive offer) D.104 specially housed with knuckle-joint for angle adjustment. 4in. mt., 5ft. screened lead attached, **75/-**. Also same make P.C. deaf-aid inserts, 1 1/2in. dia., **29/6**.

**HIGH-FIDELITY LOUDSPEAKERS**. We give immediate delivery of the fine Vitavox P.M. Speakers, K12/10 (10-watt) **£7**, K12/20 (20-watt) **£11**, despatch either 6/- Both have 15-ohms coil and Ticonal magnet. Also in stock, the new Vitavox 34-Tone, with 12-inch P.M. Speaker and Tweeter Unit with 6-cell Horn and Filter, now in fine walnut polished cabinet with louvered speaker grille, 15-ohms imp., handling up to 20-watts, **£31/10/-** (despatch 6/-).

**GRAMPIAN P.M. SPEAKERS** which we consider among the best of the commercial range, 9in. dia. handling 7-watts, 2 or 15 ohms coil (please state which required), **38/-** (desp. 1/6). **G.E.C. CABINET SPEAKERS** in sprayed grey wood cabinet approx. 11in. sq. by 7in. deep, fitted fine P.M. Unit with multi-matching transformer. Will suit any set as extension, **59/6** (desp. 1/6). **P.A. PROJECTOR SPEAKERS**—Vitavox P.M. 10-watt 15-ohms Unit with 30in. sq. all-metal Horn, **£9/15/-**, with 42in. expon. all-metal Horn, **£10/10/-**. New Reslo 10-watt 15-ohms Unit (fine clear-cut response), with 30in. Horn, **£11**, with 42in. Horn, **£11/15/-** (desp. either 6/-).

**HEAVY DUTY OUTPUT TRANSFORMERS**. Our improved "W.W." model is still supreme. Adequate supplies again in stock. Handles 25-watts. 11 ratios from 12/1 to 75/1 with C.T. for P.P. wt. 9 1/2 lb., **59/6** (des. 1/6).

**EX-GOVT. POWER TRANSFORMERS**. Prim. 230 v., Sec.—500-0-500 v. 170 m.a., 4 v. 4 a. Ct. Sc. prim., wt. 21 lb. (approx.), **49/6**. (These can only be despatched in Govt. portable case at 5/- extra).

**PRECISION MEASURING INSTRUMENTS** of highest spec. by B.P.L. Panel Meters (flush 3 1/2in.) 0/1 m.a. **59/6**, 0/500 microamps **65/-** (Square type **67/6**). 0/100 microamps, **75/-**. Combined Instruments, new portable model, 17 ranges. In moulded housing 5 1/2in. by 4 1/2in. by 3in. with range switching. D.C. volts:—0/75 mV. A.C./D.C. volts:—0/10, 50, 100, 500 and 1,000. D.C. millamps:—0/1, 10, 100 and 500. Resistance—0/1,000 ohms and 0/100,000 ohms (0/1 megohm with ext. battery).

With test prods. **£8/15/-**. **CAPACITY BRIDGES**, in lacquered steel cabinet 3 1/2in. by 4 1/2in. A.C. mains operated. Measurements:—Capacity—10 pt. to 110 mids. Resistance—1 ohm to 11 megohms. Inductance—50,000 to 500 megohms. Power Factor—0 to 50 per cent., **£18/15/-**. **SIGNAL GENERATORS**. A.C. mains operation. A.C. Frequencies:—100/250, 250/500, 500/1,000 Kc/s. 1.6/4.5, 4.5/12, 12/30 Mc/s. Accuracy 1 per cent. 1 v. in 10 ohms. All ranges mod. to depth of 30 per cent. by internal 400 c. oscillator. 6in. illuminated scale. **£21** (desp. 2/6). **STC METAL RECTIFIERS**, 12 v. 1.5 amp. **12/6**, 12 v. 6 amps. **39/6**, 12 v. 10 amps. **49/6**, 30 volt 8 amps **£4/17/6** (desp. 2/-).

**SIEMENS HIGH-SPEED KEYING RELAYS**, 2,000 ohms, 7/6. P.O. type, 9,000 ohms, 2-pole "make," **6/6**.

Please include sufficient for packing and despatch.

**M.R. SUPPLIES Ltd., 68, New Oxford Street, London, W.C.1.**

Telephone: **MUSEum 2958**

## Bargains of Excellent Value!

### SLOW MOTION DRIVE DIALS.

These superb Slow-Motion Drives are geared and in gearbox, and give 1000° of dial. The large knob is 3in. skirt type and is calibrated 0-100° and at each revolution a number 0-9 appears in the window, similar to the HRO. They are positively free from backlash, and would cost £6 each to make. **OUR PRICE is 10/- each.**

### ALL-WAVE COIL UNITS.

A beautiful job with 6 coils mounted round a low-loss plastic frame, and with a 5-pole 5-section Xaxley switch. All wired complete. Worth £3 10s. Only a few available at **10/- each**

### SELENIUM RECTIFIERS

**Type 1085A.** Input voltage 36 V. Output current 4.8 amps. The ideal heavy duty charging rectifier. ... **PRICE 40/- each.**

**Type 1008A.** Two of these used as a bridge type. Input voltage 216 V. Output current 1.2 amps. ... **PRICE 15/- each.**

**Type 1083A.** Four units are used to make a bridge. Input voltage 576 V. Output current 600 mA. One unit used half wave with reservoir condenser. Input voltage 320 V. Output current 250 mA. ... **PRICE 10/- each.**

### CONCENTRIC CABLE.

This is the cable you want. It is the only type that definitely matches the centre of a Transmitting Dipole Aerial. It is all Polythene and cost many times the price we offer it at. Attenuation DB/100ft.: 1 MC 0.18, 10 MC 0.6, 100 MC 2.0. Loading Watts: 1 MC/S 3.5 kW, 10 MC/S 1.1 kW, 100 MC/S 350 Watts. **OUR PRICE** in lengths of 20 yards or over, ... **1/6 per yard.**

Did you see our advertisement on page 16 of the November issue?

**RADIOMART**  
6881 CHAMPTON LANE LTD.

**48 HOLLOWAY HEAD, BIRMINGHAM 1,**

**CLARITY**



**PERSONALIFIED**

### WITH THIS SENSITIVE GRAMPIAN MIKE

The Gramplan M.C.R. Type Microphone reproduces voices with that crystal clearness which gives full value to every word and accentuates the "personality" of the speaker. Those who still have "make do" microphones on their P. A. Systems, should take advantage of this up-to-date, highly sensitive model which Gramplan are now in a position to supply. The M.C.R. is mounted in a spring suspension frame with the Unit Assembly housed in cast metal case. In crinkled black and nickel standard finish. Write for details now.

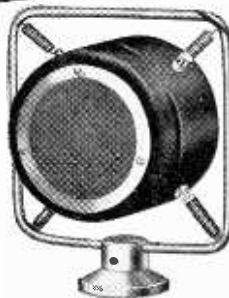

Type M. C. R. Frequency Range 80-7,500 cycles. Sensitivity Minus 45 d.b. Impedance 20 ohms. Size 2 1/2 ins. by 3 1/2 ins. frame, 6 ins. square with Base Adaptor threaded 1/4 ins. B.S.F. weight 3 1/2 lbs. List £4 - 4 - 0

**GRAMPIAN**  
LOUDSPEAKERS

GRAMPIAN REPRODUCERS LTD. Hanworth Trading Estate, Feltham, Middlesex  
Phone: Feltham 2657 Telegrams: Reamp, Feltham.

Scientific G12

## ROTHERMEL

**HIGH FIDELITY PIEZO-ELECTRIC PRODUCTS**  
available from stock.

- PICKUPS
- MICROPHONES
- HEADPHONES
- THE HUSHATONE
- DEAF AID MICROPHONES
- CONTACT MICROPHONES
- A.C. AMPLIFIERS

Also the new ROTHERMEL GENUINE SAPPHIRE High-Fidelity Gramophone Needle—over 2,000 playings.

Send for Informative Literature on all ROTHERMEL Products.

### ★ TWO NEW AMPLIFIERS

For many years R. A. ROTHERMEL has made intensive research in Amplifier design and we present with confidence two new A.C. Amplifiers, the VR/2 4 1/2-watt and the HG/308 8-watt, which have been specially designed for use in connection with all types of Crystal Microphones and Crystal Pickups. They are compact, robust, and represent the ultimate in design, workmanship, material, and quality of reproduction.

Write for Bulletin.

**R. A. ROTHERMEL LTD.,**  
**ROTHERMEL HOUSE, GANTERBURY ROAD, KILBURN, N.W.6.**  
Telephone: **MAIDA VALE 6066 (6 lines).**

# A NEW OSCILLOSCOPE



TYPE 1684B

## PRINCIPAL FEATURES

- ★ TUBE. 3½ in. diam. Blue or green screen.
- ★ Shifts. D.C. thus instantaneous on both axes.
- ★ AMPLIFIERS. X and Y amplifiers are similar. D.C. to 3 Mc/s 24 mV. r.m.s. per cm. or D.C. to 1 Mc/s 8 mV. r.m.s. per cm.
- ★ TIME BASE. 0.2 c/s. to 200 Kc/s. Variable through X amplifier 0.2 to 5 screen diameters. Single sweep available.

The Type 1684B Oscilloscope has proved itself an exceptionally useful instrument in the television laboratory—it is provided with high gain, wide band amplifiers on both axes which serve to portray pulses such as those associated with television excellently and good pulse widths are obtainable on the screen.

**PRICE £100**

**FHL FURZEHILL LABORATORIES LTD**

TELEPHONE  
ELSTREE  
1137

BOREHAM WOOD  
HERTS



*Clear as a  
Crystal*

## AND HERE IS THE REASON . . .

. . . the answer has been found in Bullers Low Loss Ceramics to the problem of Dielectric Loss in High Frequency circuits.

Years of Laboratory research and development have brought these materials to a high degree of efficiency. To-day they are in constant use for transmission and reception, and play a vital part in maintaining communications under all conditions.



**Made in  
Three  
Principal  
Materials**

### FREQUELEX

An Insulating material of Low Dielectric Loss, for Coil Formers, Aerial Insulators, Valve Holders, etc.

### PERMALEX

A High Permittivity Material. For the construction of Condensers of the smallest possible dimensions.

### TEMPLEX

A Condenser material of medium permittivity. For the construction of Condensers having a constant capacity at all temperatures.

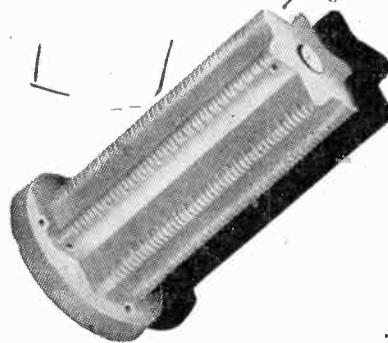

BULLERS, LTD.  
6, LAURENCE POUNTNEY  
HILL,  
LONDON, E.C.4.

Telephone :  
Mansion House 9971 (3 lines)  
Telegrams :  
Bullers, Cannon, London.

# Bullers

LOW LOSS CERAMICS



# TELCON METALS

## TELCOSEAL Glass Sealing Alloys

Where strain-free metal-to-glass seals are required the TELCOSEAL range of alloys is unsurpassed. The co-efficients of thermal expansion are carefully controlled and adapted to most types of glass as shown below.

ALLOY	GLASS
TELCOSEAL I	Borosilicate
" II	Lead Borosilicate
" III	Lead and Lime
" V	Soft Lead
" VI	Soft Lead and Soda Lime

Available as strip, rod and wire. Further details on request.

**THE TELEGRAPH CONSTRUCTION & MAINTENANCE CO. LTD.**

Founded 1864

Head Office: 22 OLD BROAD STREET, LONDON, E.C.2. Tel: LONDON Wall 3141  
Enquiries to: TELCON WORKS, GREENWICH, S.E.10. Tel: Greenwich 1040

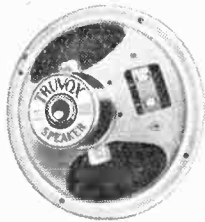

**TRUVOX** pioneers in public address loudspeakers, have produced a range of permanent magnet radio speakers of unique and very efficient construction. First supplies will be available to the radio amateur early in the New Year.

- Entirely new patented construction with single bolt fixing of components concentrically locates the chassis and complete magnet assembly.
- Brass centring ring prevents magnet being knocked out of centre.
- Special magnet steel gives powerful flux with compactness and light weight.
- Speech coil connections carried to suspension piece, ensuring freedom from rattles, cone distortion and cone tearing.
- Clean symmetrical surfaces, no awkward projections.
- Speech coil and former bakelised to prevent former distortion and speech coil turns slipping or becoming loose.
- Two point fixing to the suspension piece with four point suspension for the speech coil.
- Widely spaced fixing points for the suspension permit maximum movement of the cone, producing the lowest response physically obtainable from each size of speaker.

**TRUVOX**  
ENGINEERING CO. LTD.

- Supplied in our sizes — 5in., 6½in., 8in., and 10in.

TRUVOX HOUSE, EXHIBITION GROUNDS, WEMBLEY, MIDDX.

*Miniature or midget*

ACTUAL SIZE

ACTUAL SIZE

XY 1-4A

XW 0-75A

**NEW TYPES FOR**  
MIDGET RECEIVERS  
HEARING AIDS  
METEOROLOGICAL  
INSTRUMENTS  
ETC.

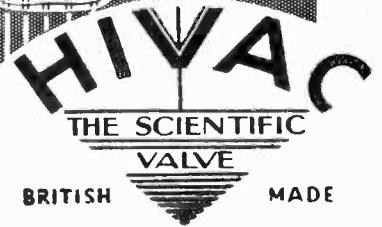

**HIVAC LIMITED** Greenhill Crescent. Phone HARROW Harrow on the Hill, Middx. 0895

## THE PYROGRIP

(PATENT APPLIED FOR)

**A HANDY GADGET FOR HOLDING SCREWS WHEN FIXING IN AWKWARD POSITIONS, SUITABLE FOR ANY SCREWDRIVERS. 5/8" DIAMETER.**

— SIMPLE — — QUICK —  
— EFFICIENT —

INDISPENSIBLE TO RADIO & ELECTRICAL ENGINEERS



DELIVERY FROM STOCK

**THE ACRU ELECTRIC TOOL MFG. CO., LTD.**  
123, HYDE ROAD, ARDWICK, MANCHESTER, 12.  
PHONE ARDWICK 4284.



1921



1946

To One and Every Friend we Send  
Christmas Greetings and Best Wishes for a  
New Year tuned in to Prosperity.

*The Directors and Staff*

**McMICHAEL RADIO LTD.**

*London Office and Sales: 190, Strand, W.C.2. Tel.: Temple Bar 2085. Grams: RADIETHER, London.*

*McMICHAEL RADIO LTD., SLOUGH, BUCKS. TEL.: SLOUGH 22311.*



*The*  
**PIFCO**  
ALL-IN-ONE  
**RADIOMETER**

*tests everything electrical*  
**RADIO, HOUSEHOLD APPLIANCES  
& MOTOR CAR LIGHTING ETC!**

**25/-**

Ask your local Factor to show you one of these remarkable instruments and to put your name down on his waiting list.

# SWITCHES ARE CONDEMNED

to  
*Hard Labour  
for Life —*



**OAK EXCLUSIVE**  
**DOUBLE CONTACT**  
**SELF-ALIGNMENT**  
**ENSURE RELIABILITY**



# OAK

SWITCHES

★ Only genuine when bearing these Patent Nos.: 478391, 478392 NSF OAK.

**BRITISH N.S.F. CO. LTD.**, Keighley, Yorkshire

London Office: 9 Stratford Place, W.1.

Phone: MAYfair 4234.

(Sole Licensees of OAK Manufacturing Co., Chicago)

# RM

## PRODUCTS INCLUDE

- Transformers.....*
- Chokes .....*
- Coils .....*
- I.F. Transformers.....*
- Mains Units.....*
- Extension Speakers.*

R.M. ELECTRIC LTD., TEAM VALLEY, GATESHEAD, 11

## THE STATIC CONDENSER Co. Ltd.

★ *Manufacturers of  
STATIC  
CONDENSERS*

### TOUTLEY WORKS, WOKINGHAM, Berks

Telephone: WOKINGHAM 708

**★ ADASTRA ★**  
GALVANISED SECTIONAL STEEL  
**RADIO MASTS**  
*Send for Catalogue WO/330*  
**POLES LTD** TYBURN RE ERDINGTON  
BIRMINGHAM 24

**10 to  
310  
mcs.**

Light Weight  
36 lbs.

Negligible  
Stray Field.

Frequency  
Calibration 1%

Modulation  
30% sine wave  
1,000- and  
pulsed 50/50  
square wave  
at 1,000-

Attenuation  
Max. error at  
300 mcs.  $\pm 2$ dB

Precision  
Slow-Motion  
Dial.

Wide Range,  
10-310 mcs.

Compact  
12½ in. x 13½ in.  
x 7½ in.

Dual-Power  
Supply  
200-250v., 40-100-  
80-v., 40-2000-

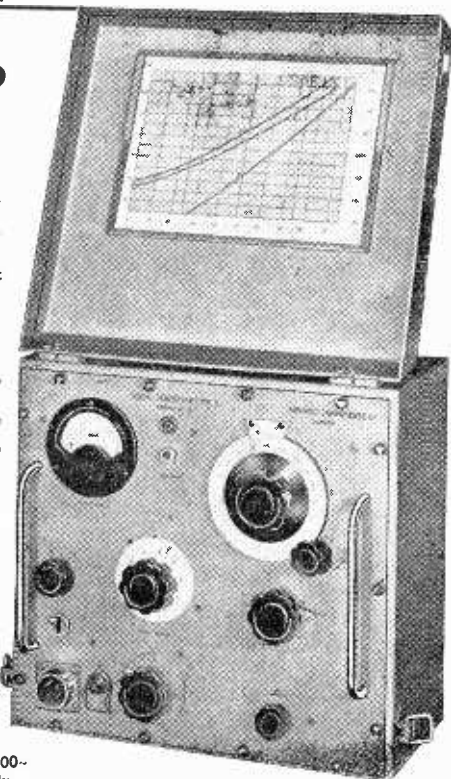

*“Advance”*  
**Signal Generator**  
**type D.1.**

This “ADVANCE” Signal Generator is of entirely new design and embodies many novel constructional features. It is compact in size, light in weight, and can be operated either from A.C. Power Supply or low-voltage high-frequency supplies.

An RL18 valve is employed as a colpitts oscillator, which may be Plate modulated by a 1,000-cycle sine wave oscillator, or grid modulated by a 50/50 square wave. Both types of modulation are internal, and selected by a switch. The oscillator section is triple shielded and external stray magnetic and electrostatic fields are negligible. Six coils are used to cover the range, and they are mounted in a coil turret of special design. The output from the R.F. oscillator is fed to an inductive slide wire, where it is monitored by an EA50 diode. The slide wire feeds a 75-ohm 5-step decade attenuator of new design. The output voltage is taken from the end of a 75-ohm matched transmission line.

The instrument is totally enclosed in a grey enamelled steel case with a detachable hinged lid for use during transport.

Price £80

Delivery ex Stock.

Write for descriptive Leaflet.

ADVANCE COMPONENTS, LTD.  
BACK ROAD, SHERNHALL STREET,  
WALTHAMSTOW, LONDON, E.17.

Telephone : Larkwood 4366-7.



**TIME ALONE WILL TELL!**

**R.S. PUBLIC ADDRESS EQUIPMENT  
IS DESIGNED FOR YOUR FUTURE**

The greatest test for any P.A. Equipment is TIME . . . how will it stand up to the passing of the years? We know that our equipment will pass this test with flying colours as it has done all others because it is designed for the future . . . your future. R.S. P.A. Equipment will give the utmost service for many years to come . . . the well thought-out design and specification of each component ensures it.

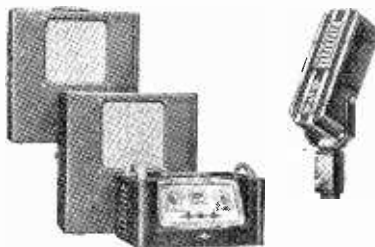

SEND TO-DAY  
FOR FULLEST  
INFORMATION

MICROPHONES

LOUDSPEAKERS

RADIO

RADIOGRAMS

AMPLIFIERS

PORTABLE EQUIPMENT



**R. S. AMPLIFIERS, LIMITED**  
REYNOLDS ROAD, ACTON LANE,  
LONDON, W.4. Phone : CHISWICK 1011

# Remember-



RADIO  
STAMPINGS

RADIO  
CHASSIS

RADIO  
PRESSINGS

FARM LANE, FULHAM, S.W.6. TELEPHONE: FULHAM 5234

## TELEVISION AERIALS

# 5-

models  
to  
choose  
from

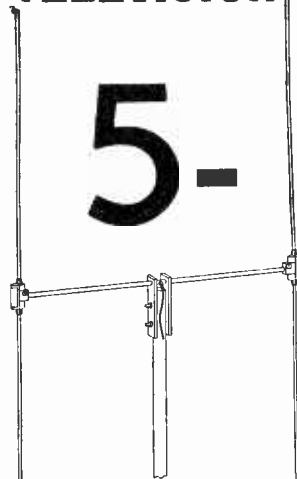

Model PD3R.  
Dipole with reflector  
for pole mounting.  
LIST PRICE £2. 7. 6.  
(mast & cable extra).

Careful  
mechanical  
design gives  
maximum strength  
for  
minimum weight.

SALES  
DEPT.

## ANTIFERRENCE LIMITED

BRYANSTON ST., LONDON, W.1 PADDINGTON 7253 4.

## IF YOU USE WAX

### We Are At Your Service

THE WIDE RANGE OF  
**OKERIN DI-ELECTRICS**

created in our own laboratories fulfils almost every need of the Electrical Industries. Grades have been designed for the most severe and varied conditions. Most are resistant to mould and fungus growth, whilst special types are evolved whenever new applications arise.

We invite discussion on problems of Insulating, Impregnating, Waterproofing, Filling Finishing, etc.

## ASTOR BOISSELIER & LAWRENCE LTD.

(Sales Dept.), Norfolk House, Norfolk Street, Strand, W.C.2

Telephone: Temple Bar 5927.

### PORTABLE TRANS-RECEIVERS.

Brand New Ex-Govt. Canadian Outfits for Immediate Use, comprising the following:—

**Carton (1).** No. 58 Mk.1 Wireless Set (Canadian Mk.1), complete with the following inside set. (2) G224 Fuses Littlefuse Type 8 AG 1/32 Amp. (2) G150 Valves Type IT4. (1) G151 Valves Type IR5. (3) G152 Valves Type 1S5. (2) G153 Valves Type 1299A. (1) G441 Screwdriver. (1) G330 Antenna Telescopic 103in. (1) G283 Antenna 4 Section of 4 Sizes (Total 16 Sections). (1) 1038 Case, Webb, Antenna Rods. (1) G394 Card, Working Instructions.

**Carton (2).** Accessories and Haversack for Wireless Set (1) G388 Haversack (Complete with Shoulder Straps and Belt). (1) G295 Wire, Antenna, Copper Rubber Covered (25ft.). (1) G324 Adaptor Antenna. (1) 1040 Case, Battery, Dry, complete with Power Cables and plugs. (2) 1044 Microphone and receivers, Headgear Assembly. (2) G439 Straps, Withdrawal, Battery.

**Carton (3).** Vibrator Power Unit for Wireless Set. (1) SC999E Vibrator Unit (Complete with the following inside unit). (1) G356 Battery "C" 21 Volt Type No. 420. (2) Batteries (Secondary) Willard No. 20-2. (1) Fuse G366 10 Amp. Littlefuse Type 3-AG. (1) Vibrator Type R76A. (1) X200 Cables Charging 6ft. (2) G150 Valves Type IT4. (1) G151 Valves Type IR5. (3) G152 Valves Type 1S5. (2) Valves Type 1299A. (1) G365 Battery "C" 21 Volt Type No. 420. (3) G366 Fuses E-3 Littlefuse Type 3-AG10 Amp. (2) G224 Fuses Littlefuse Type 8-AG 1/32 Amp. (1) R76A Vibrator.  
**£15-15-0** Carr. Paid.

**CARBON MICROPHONES.** Brand New Ex. Govt. Hand Grip Microphones with Pressure Switch Cable and Connecting Plug, 7/6. Post 7d.

**MOVING COIL MICROPHONE & DOUBLE HEADPHONES** Ex. Govt. Slightly Used but Guaranteed O.K. (Contains 3 Moving Coil Insets). 10/6 each. Post 7d.

### • NEW RADIO RECEIVERS •

Over 100 New Sets For Prompt Delivery. Send Your Order to Us. Safe Delivery Guaranteed. Carriage Paid. We are Agents for: PYE, PHILIPS, EKCO, ULTRA, MARCONI, PHILCO, etc.

Terms of Business; Cash with Order. Money Returned Without Quibble if not Satisfied.

## H. P. RADIO SERVICES LTD.

55, County Road, Liverpool, 4

Tel.: Aintree 1445.

Estab. 1935.



# Again published—the Eddystone Short Wave Manual

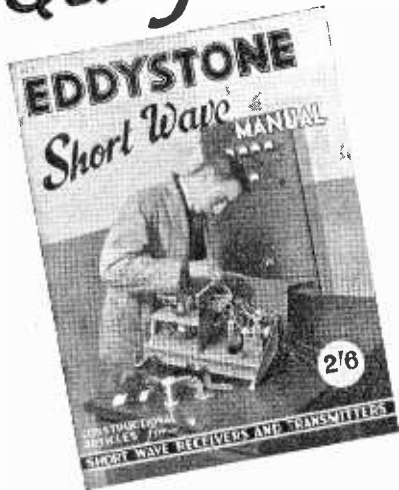

This popular manual of absorbing interest to every Ham and Short Wave Radio constructor is now available. The Eddystone Short Wave Manual can be obtained ONLY from authorised Eddystone Dealers.

## WE REGRET—A NOTE OF WARNING

It is our duty to you (and in fairness to all our registered Dealers) to be frank regarding the present supply position of Eddystone Components. In view of to-day's manufacturing difficulties (common to all) we are not finding it easy to meet the demand as quickly as we would wish. We must in the Nation's interest maintain our Export Drive thus leaving only a portion of our output for the Home Market. To avoid disappointment, order your Eddystone Components well in advance. Don't blame your dealer if he cannot fulfil your entire requirements over the counter—he is doing his best for you and we are doing our best for him. You may be sure that we, the manufacturers, are doing everything possible to increase output. Distribution of our products will be made evenly throughout the country—you may not have to wait, but if you do, please be patient.

*(If you do not know your local Eddystone Dealer, we will, if you desire, send you his address. Please send postage. We do NOT supply direct.)*

Published by

**STRATTON & Co., Ltd., Eddystone Works, Alvechurch Road, West Heath, B'ham 31**

**WHERE YOU NEED IT!**

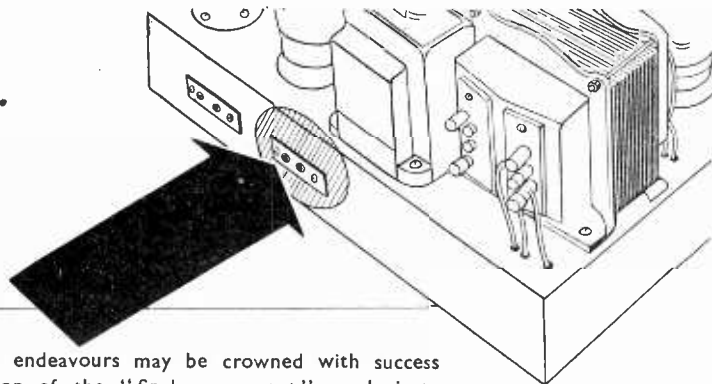

So that your endeavours may be crowned with success your selection of the "final component" needs just as much discrimination as do the other details of your circuit.

Stentorian speakers are specially designed to match any desired impedance. As you listen to the faithful reproduction from your Stentorian, you will be delighted at the results you are obtaining. Ask your dealer to demonstrate.



**PERMANENT MAGNET MOVING COIL SPEAKERS**

# Stentorian

THE FINEST EXTRA SPEAKER FOR ANY SET

**PRICES**

Minor Type MX (for Low Impedance Extension)	39/6	Baby Type BX (for Low Impedance Extension)	53/6
Minor Type MO (with Universal Transformer)	45/6	Baby Type BO (with Universal Transformer)	59/6

**WHITELEY ELECTRICAL RADIO CO. LTD., Mansfield, Notts.**

# WHY

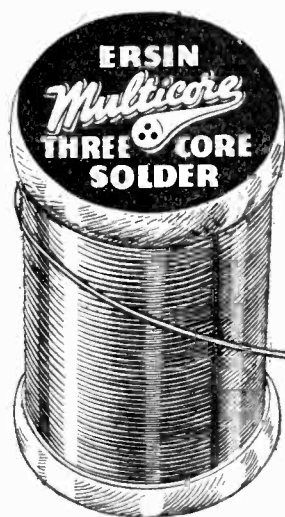

# CORE

# SOLDER

Because only with a solder wire having more than one core of flux can you be sure that the flux is always present. The 3 cores of Ersin Multicore Solder are filled with Ersin—the extra active non-corrosive flux. Only Ersin Multicore Solder can guarantee you freedom from dry joints, elimination of waste, rapid melting and speedy soldering. Write for technical information and free samples to Multicore Solders Ltd., Mellier House, Albemarle Street, London, W.1 or phone REGent 1411 (P.B.X. 4 lines).

# Wireless World

Radio and Electronics

36th YEAR OF PUBLICATION

## DECEMBER 1946

Proprietors:  
ILIFFE & SONS LTD.

Managing Editor:  
HUGH S. POCOCK,  
M.I.E.E.

Editor:  
H. F. SMITH

Editorial, Advertising  
and Publishing Offices:  
DORSET HOUSE,  
STAMFORD STREET,  
LONDON, S.E.1.

Telephone:  
Waterloo 3333 (50 lines).  
Telegrams:  
"Ethaworld, Sedist, London."



PUBLISHED  
MONTHLY

Price: 1/6

(Publication date 26th  
of preceding month)

Subscription Rate:  
Home and Abroad  
20/- per annum.

MONTHLY COMMENTARY .. .. .	385
SIMPLE VALVE TESTER. By R. E. Hartkopf .. .. .	386
NOISE FACTOR. By L. A. Moxon .. .. .	391
SHORT-WAVE CONDITIONS .. .. .	393
TEST REPORT: MURPHY A104 .. .. .	394
PARALLEL STANDARD RESISTORS .. .. .	396
NOISE LIMITERS. By H. B. Dent .. .. .	397
WORLD OF WIRELESS .. .. .	399
TEST REPORT: PYE TELEVISION MODEL B16T .. .. .	403
RADIO v. U-BOAT. By G. M. Bennett .. .. .	408
LETTERS TO THE EDITOR .. .. .	412
DESIGN DATA (9): VIDEO AMPLIFIER H.F. RESPONSE—PART III .. .. .	413
WHAT IS RADAR? (AGAIN). By "Cathode Ray." .. .. .	415
TELEVISION SOUND REJECTION. By W. T. Cocking .. .. .	417
WIDE RANGE TONE CONTROL. By J. M. Hill .. .. .	422
LOUDSPEAKER TRANSIENTS .. .. .	424
UNBIASED. By Free Grid .. .. .	426
RANDOM RADIATIONS. By "Diallist" .. .. .	427
RECENT INVENTIONS .. .. .	430

Branch Offices:

COVENTRY:  
8-10, Corporation Street.  
Telephone: Coventry 5210.  
Telegrams:  
"Autocar, Coventry."

BIRMINGHAM:  
King Edward House,  
New Street.  
Telephone:  
Midland 7191 (7 lines).  
Telegrams:  
"Autopress, Birmingham."

MANCHESTER:  
260, Deansgate, 3.  
Telephone:  
Blackfriars 4412 (4 lines).  
Telegrams:  
"Iliffe, Manchester."

GLASGOW:  
26B, Renfield Street, C.2  
Telephone: Central 4857.  
Telegrams: "Iliffe, Glasgow."



*As many of the circuits and apparatus described in these pages are covered by patents, readers are advised, before making use of them, to satisfy themselves that they would not be infringing patents.*

## VIBRATORS • TRANSFORMERS • SWITCHES • COILS

'Stratosil Sealed'  
for EFFICIENCY

Wearite "Stratosil Sealed" Vibrators operate efficiently and with the utmost reliability in all situations irrespective of climatic conditions. They embody many features exclusive to this type of component.

**STRATOSIL**  
Sealed VIBRATORS

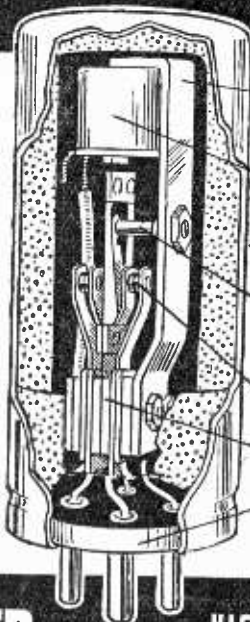

- All steel construction—even to the rivets—ensuring uniform expansion under extremes of temperature.
- Reed driving coil—wound on a bakelite moulded bobbin to meet all climatic conditions.
- Metal can, sponge rubber lined—Acoustically and electrically shielding the Vibrator.
- Driving contact of non-tarnishable precious metal—ensuring starting under the lightest of pressures and voltages.
- Contacts ground almost to optical limits.
- Stack assembly. Mica and steel only are used.
- Base sealed by the WEARITE STRATOSIL process.

**WRIGHT & WEAIRE LTD**

HIGH RD. TOTTENHAM N.17  
TELEPHONE: TOTTENHAM 3847

## NEW ... but with a Time - Tested technique

Twenty-five years ago Mullard successfully pioneered the silica thermionic valve. The need then was for a valve with long electrical life plus mechanical strength—strength that would withstand the concussion of a battleship's broadside.

To-day, when valves must stand up to the trying requirements of industrial applications, this unique experience is proving invaluable. Designers can choose a modern Mullard Silica Valve and be confident of dependable performance under all conditions.

The TYS4-500 R.F. Power Triode is typically efficient, dependable and economical. The thoriated tungsten filament provides high emission at low filament consumption. The silica envelope will bear high temperatures and does not require forced air or water cooling. And, finally, like other types in the Mullard silica range, the TYS4-500 is *repairable*—an important extra factor to bear in mind when considering low cost per life/hour.

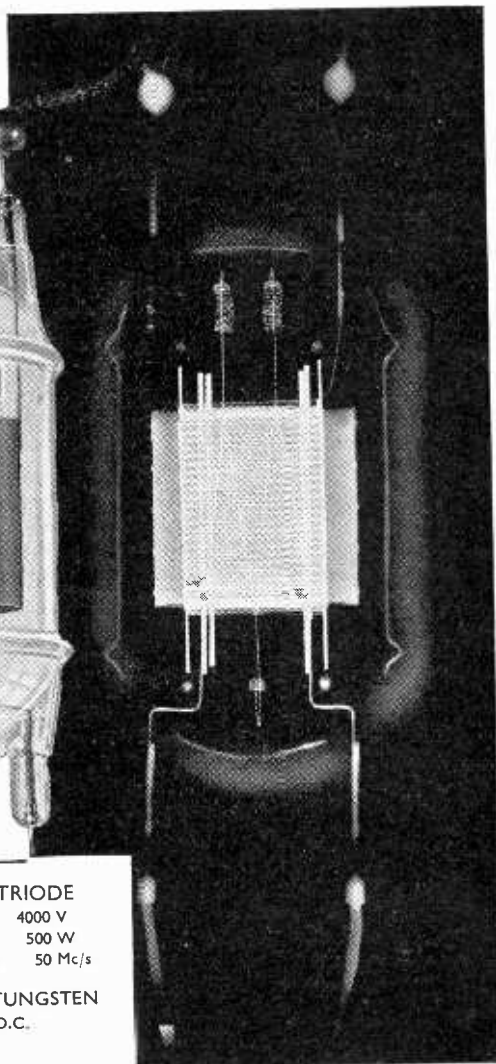
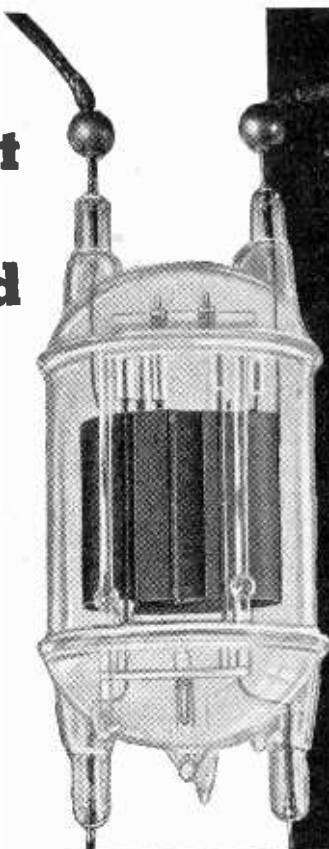

**TYS4-500 R.F. POWER TRIODE**  
 Anode Voltage 4000 V  
 Anode Dissipation 500 W  
 Max. Frequency for full Ratings 50 Mc/s

**FILAMENT — THORIATED TUNGSTEN**  
 Voltage 10 V A.C. or D.C.  
 Current 10 A

For further developments watch

# Mullard

## THE MASTER VALVE



Technical data and advice on the application of the TYS4-500 and other Silica valves can be obtained from:—

THE MULLARD WIRELESS SERVICE CO. LTD., TRANSMITTING AND INDUSTRIAL VALVE DEPT., CENTURY HOUSE, SHAFTESBURY AVENUE, LONDON, W.C.2

# Wireless World

Radio and Electronics

Vol. LII. No. 12

DECEMBER, 1946

Price 1s. 6d.

## Monthly Commentary

### *Engineers and Technical Assistants*

A CORRESPONDENT, whose letter is printed elsewhere in this issue, raises questions that are important to all who are in any way concerned with the more technical branches of wireless, whether as employer or employee. Briefly, he says that there are too many radio engineers, that their capabilities are misused and that there are not enough technical assistants.

It is not intended to comment on the first statement, but the second is borne out by our own observation, both in industrial and in other establishments. All too often one sees professionally qualified engineers—the term is used here in its strictest sense—occupied in tasks that could be done competently by those of much lower technical qualifications.

We are less willing to agree with our correspondent's third contention—that there is an inadequate supply of "technical assistants." During the war, large numbers received training and had experience in every branch of the art. Of these a very considerable proportion wished to remain in radio permanently, and we know that many have in fact adapted themselves successfully to peacetime jobs. After a short refresher course in civilian practice, many more could do so.

The scope of the technical assistant is already wide, and it is likely to become wider. As radio technique and practice become more stabilized and standardized his functions tend to change. His status and conditions of employment are not always as good as they should be if we take into account the hardly-won knowledge and assiduously cultivated qualities that are now needed to make a success of almost any technical radio job. Even his title might be changed. True, there is nothing derogatory in the term "technical assistant"; most of us are assistants to someone or other. But it seems undesirable to cultivate and emphasize in a title the idea (which, as our correspondent points out, certainly exists) that the holder is auto-

matically debarred from promotion to higher grades. If there is in fact a shortage of competent men to assist those trained to do the basic work, then the remedy is to make the job more attractive.

### *Television and the Cinema*

A GOOD deal of interest attaches to a recent statement made by J. Arthur Rank, Chairman of Cinema Television. Mr. Rank said "We are very desirous in the film industry that they [the B.B.C.] should not have a monopoly in televising to the large screens. We are not asking that the monopoly to homes should be interfered with, but we are asking that . . . private enterprise should have a right to their own studios to televise their own programmes to large screens in cinemas and public halls." It was further stated that good and steady progress was being made in evolving a distributing system of much higher definition than that of the B.B.C.; also that the Post Office attitude towards the big-screen experiments was "co-operative." But Mr. Rank hinted that relations between the film interests and the Television Advisory Committee had been less harmonious.

The projected system to which these statements relate, comprises, we assume, a distribution network employing television technique (but perhaps with R.F. cables) between a central studio and a group of halls for public viewing.

In radio circles there seems to be a tendency in some quarters to regard the project with uneasiness, as something likely to interfere with the interests of pure television broadcasting. This attitude runs contrary to the view—which we believe is widely accepted—that a large measure of co-ordination between cinema and television is desirable, and likely to be beneficial to both. Surely the Cinema Television scheme, and any others on similar lines, are likely to lead ultimately to a practical form of co-operation. Such schemes provide a brand-new outlet for television, and, far from leading to wasteful competition, should foster healthy rivalry. Above all, any extension of the scope of television should stimulate technical development.

# SIMPLE VALVE

## Checking Insulation, Mutual Conductance and Emission

By

R. E. HARTKOPF

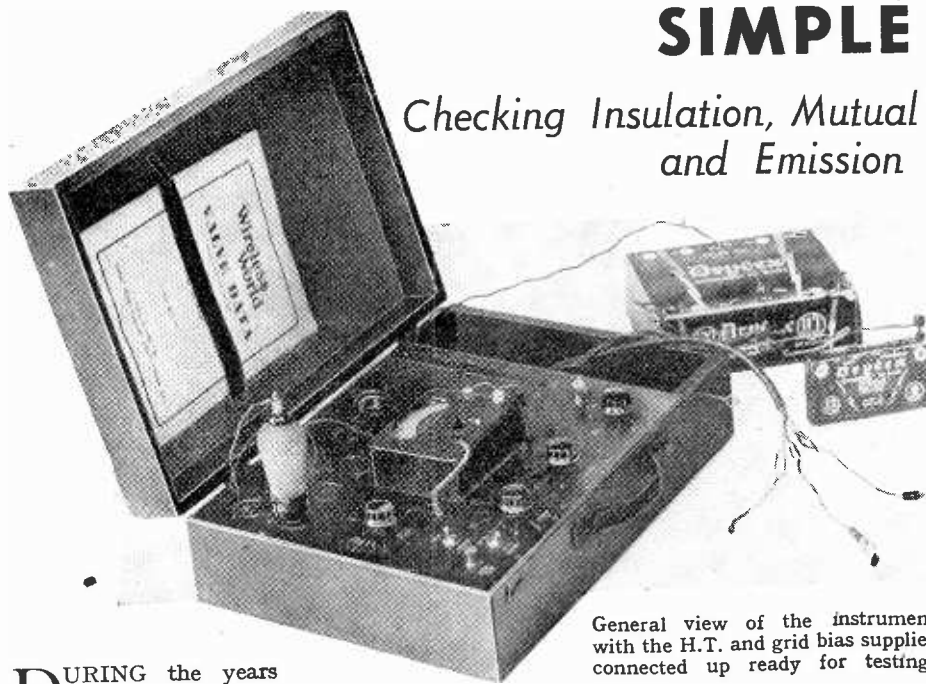

General view of the instrument with the H.T. and grid bias supplies connected up ready for testing.

**D**URING the years before the war there appeared on the market a variety of valve testers, most of which were designed for the purpose of enabling unskilled persons, such as shop assistants, to give a customer a rough idea of the general condition of a valve. These were, however, of little interest to the amateur with the time and skill necessary for the use of a more flexible instrument and who did not handle a sufficient number of valves to justify the cost of expensive commercial testers.

It was in view of these considerations that the present valve tester was designed. While it is not as quick and simple to operate as the commercial type, it is relatively simple and the materials necessary for its construction are readily obtainable. It is cheap and is built into a case for the sake of portability; and having been constructed for use with batteries it can be taken to and used in places where mains power is not available. It can be built to accommodate as many types of valve base as required and the *Wireless World Valve Data* book will supply all the information necessary for its use. In this respect it has a considerable advantage over those commercial instruments which give readings having

no significance except in relation to the special instruction book supplied by the makers.

### Basic Circuits

The function of a valve tester is twofold. In the first place it has to provide a means of applying a set of predetermined conditions to the valve to be tested; and in the second place to measure the results obtained by the application of this set of conditions. The multiplicity of valve types and bases which have to be dealt with make the instrument appear at first sight to be somewhat complicated, but if the basic circuits are followed and understood their outlines in the complete circuit can be easily traced.

The parameters which give the most useful information regarding the condition of a valve are the emission and mutual conductance in the case of multi-electrode valves and the emission in the case of diodes and rectifiers. Since there are a number of books dealing with valves and their principles of operation\* it is not the intention of the writer to discuss this aspect of the matter, but to

\* E.g., "Introduction to Valves," by F. E. Henderson. Iliffe & Sons)

use the available space in dealing with the methods by which these parameters are measured.

In considering the measurement of mutual conductance and emission (excluding rectifiers, etc.) a difficulty at once arises due to the fact that, while the emission is fixed by the conditions applied to the valve

the mutual conductance is a ratio  $dI_a/dV_g$ , and since the characteristic of a valve is only straight for a small portion, the change in bias should be as small as possible in order to obtain accurate results. If, however,  $dV_g$  is small the resultant change in

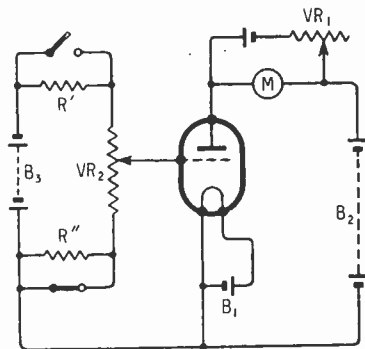

Fig. 1. Basic circuit for mutual conductance and emission.

anode current  $dI_a$  will also be small and not easily read on a meter having a range capable of handling the whole emission current. If, on the other hand, the change in bias  $dV_g$  is made large enough to give a readable change in anode current,  $dI_a$ , a misleading result is likely. Fig. 4

# TESTER

gives an example of this, showing how an erroneous result can arise if the change in bias is excessive for the type of valve under test.

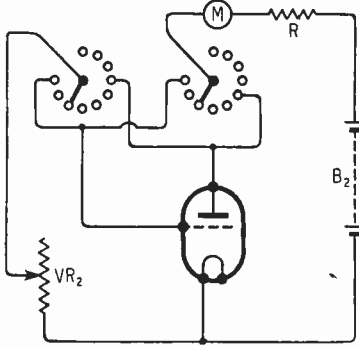

Fig. 2. Basic circuit for element shorts.

In Fig. 1, showing the basic circuit for the testing of mutual conductance and emission, it will be seen that the above difficulty has been overcome by the use of a unit dry cell and a variable resistor  $VR_1$ . By adjusting  $VR_1$ , a current equal and opposite to the emission current can be supplied, and thus the current flowing through the meter  $M$  will be reduced to zero.  $VR_1$  is provided with a pointer and a circular scale on which, when the meter has been adjusted to zero by rotating the pointer, the neutralizing and therefore the emission current (which is equal and opposite) can be read off directly in milliamps. Since the limitation imposed by the emission current on the sensitivity of the meter is thus removed, the change in bias  $dV_g$  can now be reduced to a much smaller value dependent only on the range required and the sensitivity of the meter available. This

TABLE

Meter F.S.D. (mA)	Range (g)			
	0-1	0-5	0-10	0-15
2.5	2.5	0.5	0.25	0.17
1	1	0.2	0.1	0.05
0.05	0.05	0.01	0.005	0.003

Bias change required for various meters and ranges,  $dV_g = D/g$  where  $dV_g$  is the bias change in volts,  $D$  the meter full-scale deflection in mA, and  $g$  the range in mA/V.

relationship is shown in more detail in the table, where it will be seen that for valves having a small grid voltage swing together with a low mutual conductance the most sensitive meter has every advantage. Another advantage of this arrangement is, of course, that it makes it possible to read the mutual conductance direct on the meter scale and does away with the necessity for taking the difference of two current readings.

The final point of interest in the basic circuit of Fig. 1 is the method of providing the required change of bias  $dV_g$ . Here the requirements are, first, that it should give the greatest degree of accuracy possible without giving rise to exceptional constructional difficulties, and, second, that it should itself remain constant while at the same time allowing the nominal bias to be readily ad-

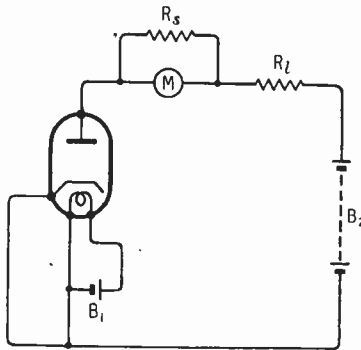

Fig. 3. Basic circuit for rectifiers, diodes, etc.

justed to suit the requirements of the valve to be tested. This is achieved by means of the arrangement comprising  $R'$ ,  $VR_2$  and  $R''$ , which are connected in series across the bias supply battery  $B_2$ . In the normal position  $R'$  is short-circuited and  $R''$  is in circuit. When the "bias" switch is depressed to obtain a mutual conductance reading,  $R''$  is shorted and  $R'$  put in circuit as shown in the figure. The two resistors being identical and carrying a potential drop equal to the required change in bias,  $dV_g$ , this change in bias will be applied to the grid of the valve irrespective of the position of the slider of  $VR_2$ , and the slope of the valve for any nominal bias position determined simply by setting the

slider, pressing the "bias" switch and reading the mutual conductance directly on the meter scale ( $VR_1$ , of course, being first adjusted to neutralize the emission current associated with the chosen nominal bias).

The basic circuit of Fig. 2 shows an arrangement for testing for element shorts. Since the bias and the anode supply are connected to selector switches capable of applying them to any pin desired, it follows that, if the neutralizing current circuit and  $B_2$  and  $B_1$  of Fig. 1 are open-circuited, the arrangement becomes suitable for testing for element shorts. A resistor  $R$  (Fig. 2) must be included to limit the current to an amount suitable for producing full-scale deflection on the meter with the H.T. voltage employed. The potentiometer  $VR_2$  is turned to minimum position so that it is not included in the circuit. Then by rotating the anode selector switch a full turn the insulation of each element in relation to the heater is automatically checked and leaks between any two elements can be checked by setting the anode selector to the one and the grid selector to the other.

The basic circuit for testing for emission for rectifiers, etc., shown in Fig. 3 follows much the same lines, but here a shunt resistor  $R_s$  is switched in across the meter to enable a heavier current to be used (25 mA, max. in the original instrument), and  $R$  is replaced by a heavier resistor of a lower value

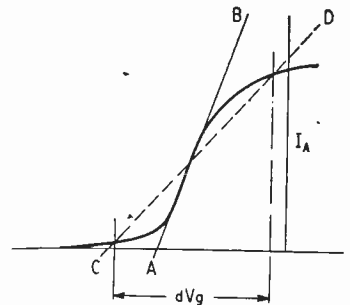

Fig. 4. Error arising when bias swing  $dV_g$  is excessive,  $AB$  is the real, and  $CD$  the apparent slope.

$R_1$ . As there are only two connections (i.e., anode and cathode) in this operation, the grid selector switch is not required, and the bias network is automatically ex-

**Simple Valve Tester—**

cluded from the circuit. The anode selector switch is set to the anode pin, and B<sub>1</sub> must, of course, be in circuit. Although in this test the meter gives results having only comparative significance, a little practice makes it quite easy to obtain a sufficiently accurate estimate of the condition of the valves.

**Power Supply**

From the circuit diagram shown in Fig. 5 it will be seen that a separate power supply must be provided for the instrument. Although there is no reason why a power pack should not be incorporated, the cost and difficulty of obtaining a transformer having a full range of filament and heater voltages together with smoothing condensers, chokes, etc., constituted some objection. Moreover, since the instrument was designed primarily for use where no mains power was available, the adaptation for mains working would

have been a drawback rather than an advantage. In practice the power supply has never presented any difficulty, as for checking valves in a battery set the batteries are always available, and if a mains set is being handled the power can usually be drawn from the power supply of the set itself. This is, of course, based on the assumption that the power supply section is working, but as this is the first thing which should be examined when checking a mains set there should be no practical difficulties.

The only difficulty in the power supply likely to be encountered is the provision for the heater voltage for high voltage AC/DC valves, but if the simple arrangement shown in Fig. 6 consisting of lampholders wired up in parallel is used and a selection of lamps ranging from 15 to 100 watts is kept handy, it will be found possible to provide for any contingency which may arise. If a low-wattage lamp is inserted first and a suitable voltmeter connected across the leads to the valve tester it is quite easy to

bring the voltage to the required amount without overloading the valve. Experience has shown that this method is simple and

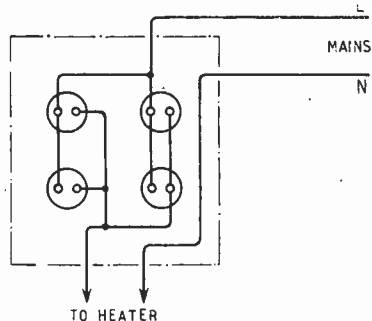

Fig. 6. Lampholder panel for heater supply for A.C./D.C. valves.

effective, and in skilled hands the danger from a direct mains connection is very slight. This danger is further minimized by the use of the switch S<sub>1</sub>, S<sub>2</sub> (Fig. 5), which when put over isolates the heater from the other circuits and also cuts out the indicating lamp, a 6-volt flashlamp bulb, which is used as an indicator for the low-voltage valves only.

Whatever the method of providing high tension and heater power, the grid bias supply always comes

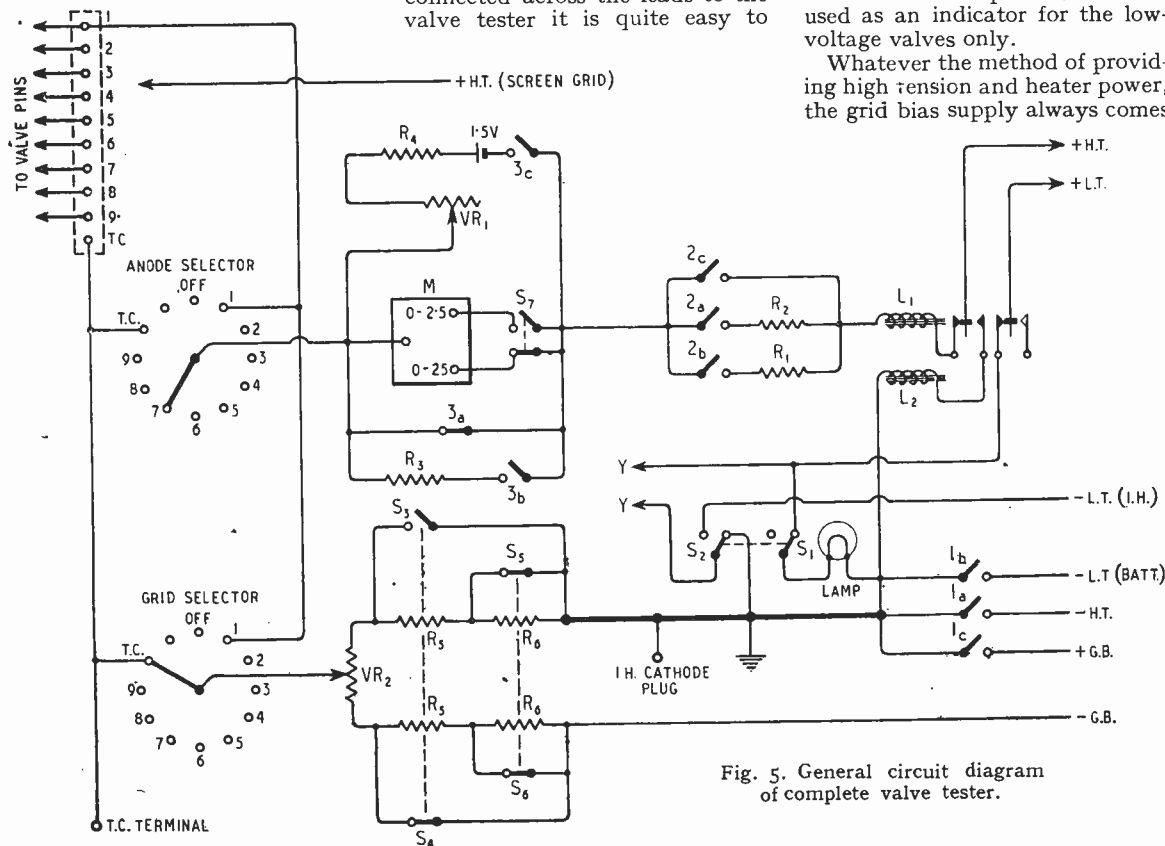

Fig. 5. General circuit diagram of complete valve tester.



from a battery connected across the GB+ and GB- leads. A 9-volt grid battery was used in the original instrument, and as the current drawn is in the region of half a milliamp, a constant P.D. across the bias network is easily maintained. It is a good practice, however, to check the voltage of this battery fairly frequently as

the valve bases; the numbering scheme for the valves being that used in the *Wireless World* Valve Data book. To minimize the risk of a short circuit, however, the heater pins on each base are missed and these are only connected in parallel to the points Y, Y shown in Fig. 5. If all the heater pins are wired

three IO8 bases will overcome this difficulty they are not essential, as in the rare cases where it is necessary a non-standard heater connection can be made by making a connection to the appropriate heater pin through the appropriate numbered plug on the panel.

The switching sequence will be clear from a study of Fig. 7 together with the general circuit diagram of Fig. 5. Twelve-point switches of the wafer type are used, and it is a fairly simple matter to rearrange the contacts to suit requirements. For switch 1<sub>b</sub> all the available contacts are used in parallel, since heavy heater currents would tend to overload a single contact. Switch 3<sub>a</sub> was available and was wired up to ensure that, when setting up, the wander plug was not inserted in the ohm range of the multi-range meter by mistake, as this was near one of the current range plugs used. Although, in the original instrument, it was not considered that the cost of a special meter for the instrument would be justified and an available multi-range meter was therefore arranged to be temporarily

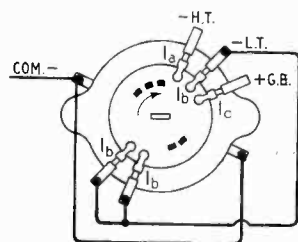
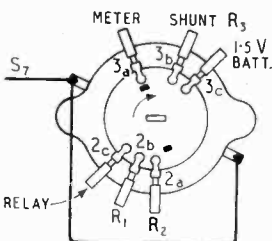

Fig. 7. Arrangement of two-bank wafer switch and connections.

SW.	POSITIONS			
	OFF	1	2	3
1 <sub>a</sub>	0	C	C	C
1 <sub>b</sub>	0	0	C	C
1 <sub>c</sub>	0	0	0	C
2 <sub>a</sub>	0	C	0	0
2 <sub>b</sub>	0	0	C	0
2 <sub>c</sub>	0	0	0	C
3 <sub>a</sub>	C	0	0	0
3 <sub>b</sub>	0	0	C	0
3 <sub>c</sub>	0	0	0	C

POSITION 1 - LEAK TEST  
 2 - EMISSION  
 3 mA/V



the accuracy of the instrument depends to a considerable extent on the voltage of this battery remaining constant.

**General Circuit Description**

With the help of the photographs and the circuit diagram Fig. 5 the application of the above notes to the general circuit should be clear. The components are all mounted on a sheet of 16-gauge steel (an old motor car panel was used). Ten valve bases were used with provision for the addition of two more should any unexpected requirement arise. The overall size of the case is 18½in x 12½in x 6in deep. To achieve a compromise between ease of construction and simplicity of operation anode and grid selector switches only are provided, and multi-electrode valves have the other necessary connections made from the row of numbered plugs at the top right-hand side of the instrument. Each numbered plug is connected to the points on the selector switches bearing the same numbers and then to the appropriate pins on

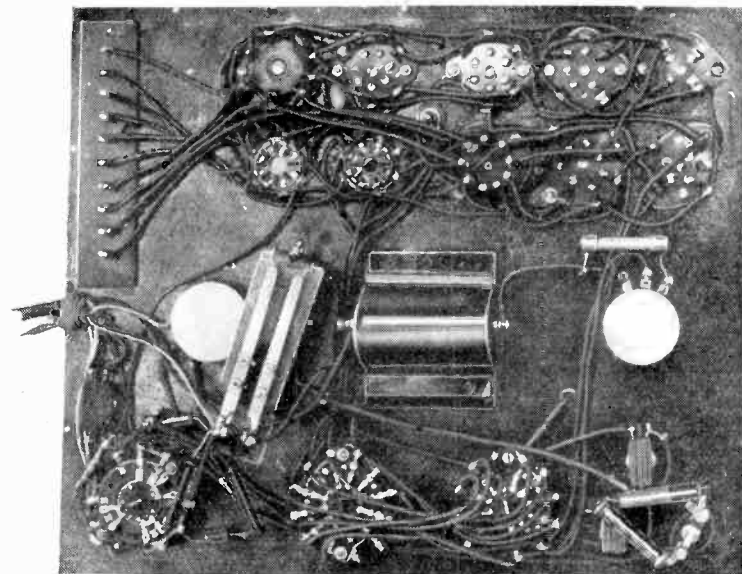

Underside of the tester. The two wafer selector switches (bottom centre) and the two bank operating switch (bottom left) are visible. The plug panel is top left, and the cover in the centre houses the unit cell supplying the neutralising anode current.

a standard valve, say, IO827 is tested the results are apt to be a little peculiar. While the use of

connected up whenever the instrument was used the incorporation of a meter permanently in the in-

### Simple Valve Tester—

strument would undoubtedly be more convenient and could quite easily be arranged and if the instrument were used frequently the cost might well be justified. If, in addition, considerable accuracy is required in plotting slopes for experimental purposes, it will be seen from the table that a meter having a full-scale deflection (F.S.D.) of 0.05mA, and working on a range of 0.10mA/V, requires a bias change of only 0.005 volts. For general testing work, however, the writer found that a meter having a F.S.D. of 2.5mA and working on a range of 0.10mA/V, was satisfactory.

The other switches used in the instrument are of the tumbler type, but for the sake of convenience the meter switch, comprising  $S_3$  and  $S_4$ , should be a spring return push-button type.

Although a protecting fuse would be satisfactory, a quick-acting telephone relay was used as a protective device in the original instrument. It is arranged to cut out at 30mA and breaks both the L.T. and H.T. lines. When this happens a third contact makes, connecting  $L_2$  across the H.T. and the relay is thus held open until the instrument is switched off

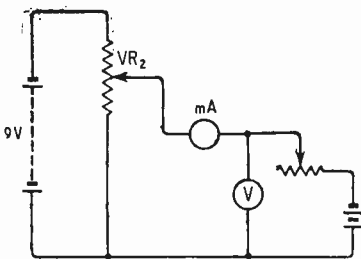

Fig. 8. Potentiometer method of determining and calibrating grid bias voltages.

when the relay automatically re-sets to its normal position. The limit of 30mA was chosen in view of the available components and expected requirements, but there is no reason why a wider range should not be used if desired.

In order that the instrument may give direct readings of mutual conductance and emission (excluding rectifiers) it is necessary during the construction to mark off scales for  $VR_1$  and  $VR_2$  and accurately determine the values of the two identical resistors  $R_5$  (and  $R_6$ , if

a second range is required). These components are shown in Fig. 5. The calibration of  $VR_1$  is a straightforward matter, consisting of mounting it on the panel with a knob and pointer attached and wiring it in series with a unit cell, a milliammeter, and the limiting resistor

$R_4$ . As the pointer is rotated over the scale the readings on the milliammeter are marked on the scale. It should be noted that there is no zero current position, the current varying from the required minimum, depending on the values of  $VR_1$  and  $R_4$  to the required maximum, depending on the value of  $R_4$  alone.

A similar knob and pointer is required for  $VR_2$ , but since here it is a potential and not a current which is to be measured it is necessary that no current should be drawn from the slider of the potentiometer. This is achieved by the use of the method shown in Fig. 8, and it will be seen that when the variable resistor in series with the voltmeter  $V$  is adjusted so that no current is flowing through the milliammeter the voltage shown on the voltmeter is that existing at the tapping point of the slider of  $VR_2$ . By this means a scale of voltage which is used to set the nominal bias voltage for the valve to be tested can be marked on the panel of the instrument. It will be noticed that this method ignores the effect of the bias change voltage dropped over resistors  $R_5$  and  $R_6$  in the complete circuit of Fig. 5, but as this bias change potential should be in the region of 1/10 volt or less, the effect on the nominal bias is negligible.

The final operation is the determination of the value of the bias dropping resistor  $R_5$  (and  $R_6$  if a second range is required), and from Fig. 5 it will be seen that the circuit consists of the grid battery, one of the identical resistors  $R_5$  and the potentiometer  $VR_2$ . By applying Ohm's Law to this circuit a formula can be derived,  $R_5 = VR_2 / (E / dV_g - 1)$

### COMPONENTS AND VALUES

Resistors		
$R_1$ .	Emission test limiting resistor ... ..	5,000* ohms
$R_2$ .	Leak test limiting resistor ... ..	48,000* "
$R_3$ .	Meter shunt resistor ... ..	3.33* "
$R_4$ .	Neutralising current limiting resistor ... ..	60 "
$R_5$ .	Bias change dropping resistor ... ..	571* "
$R_6$ .	Bias change dropping resistor ... ..	805* "
$VR_1$ .	Neutralising current adjuster ... ..	5,000 "
$VR_2$ .	Bias adjusting potentiometer ... ..	20,000 "

Switches		
$S_1$ .	Mains-battery heater switch. (Toggle.) ...	D.P.D.T.
$S_2$ .		
$S_3$ .	Bias switch. (Push, spring return.) ...	D.P.S.T.
$S_4$ .		
$S_5$ .	Range switch. (Toggle.) ... ..	D.P.S.T.
$S_6$ .		
$S_7$ .	Coarse—fine adjustment. (Toggle.) ...	S.P.D.T.

\* The values of these components depend on the type of meter used. See Table.

ohms, where

$VR_2$  is the resistance of the potentiometer in ohms,  $dV_g$  is the required change in bias in volts and  $E$  is the E.M.F. of the bias battery in volts.

Having determined a value for  $R_5$  in this way a standard wire-wound resistor having a higher resistance can be obtained and then unwound until it is reduced to the value required.

The usual multi-range meter is hardly accurate enough for this purpose, and the ammeter-voltmeter method, or if available the Wheatstone bridge, should be employed.

The actual use of the valve tester in conjunction with the *Wireless World* Valve Data book should present little difficulty. Before setting the main switch to the mA/V position,  $S_7$  (Fig. 5), which switches in a shunt resistor (in this case in the meter itself) to enable the meter to carry the required emission current, is put over and  $VR_1$  adjusted until a zero reading is obtained on the meter.  $S_7$  is then returned to the normal position and the mutual conductance can be read directly on the scale of the meter when the "bias" switch is depressed. The emission current can at the same time be read off on the circular scale of  $VR_1$ .

A little experience of the instrument will show that, apart from the normal work of testing the condition of valves, its flexibility can prove of great use in examining the behaviour of valves under non-standard conditions of voltage, etc. Valves can be tested with a resistive load in the anode circuit and the nominal bias can be varied and the slope estimated for the whole curve of the valve.

# NOISE FACTOR

## I.—A New Conception of Receiver Sensitivity and Signal/Noise Ratio

OF all the various characteristics of wireless receivers, sensitivity is probably the most important. It has been common practice to define it as the microvolts required to produce some arbitrary standard output, but this is not entirely satisfactory because, to acquire meaning, such figures have to be related to various other properties of the receiver. The need for a better definition, which was felt particularly keenly in the development of radar receivers, has resulted in the general adoption of the new "noise factor" concept. This defines sensitivity in a way which is both simple and fundamental, and also represents a change of outlook which has led to the evolution of various techniques for improving sensitivity as well as to greatly simplified and improved methods of sensitivity measurement.

It is possible to distinguish two classes of receiver, those which are required to be as sensitive as possible, and the kind which is only required to deal with signals considerably stronger than the inherent noise level. In the latter case it is necessary to define sensitivity in arbitrary terms such as " $x$  millivolts input for  $y$  milliwatts output." Here we are concerned only with the first type, and it is assumed that adequate gain is available so that the ability to detect weak signals is determined only by the noise level and not by lack of amplification.

### Aerial Noise

The inherent noise level consists partly of circuit (or thermal) and valve (or shot) noise originating in the receiver, and partly of the noise coming from the aerial itself. This aerial noise sets a definite limit to the improvement in usable sensitivity which can be obtained by perfecting the receiver, and provides the basis for defining noise factor. It can

be assumed that the aerial appears to the receiver as a resistance  $R$  (any reactive component of its impedance being tuned out) and if it behaves as an ordinary resistance its thermal noise level should be given by the well-

By L. A. MOXON,  
B.Sc., A.M.I.E.E.

known Nyquist<sup>1</sup> formula  $E^2 = 4KTBR$  where  $E$  is the noise voltage across the terminals of the resistance,  $K$  is Boltzmann's constant, equal to  $1.38 \times 10^{-23}$  joules per °C,  $T$  is the absolute temperature on the Kelvin scale ( $^{\circ}\text{C} + 273$ ) and  $B$  is the "energy bandwidth," as defined later, in cycles per second. It is useful to put this expression into an alternative form, as follows: given a generator of internal impedance  $R$  maximum power is delivered to a load when the load impedance is also  $R$ , and if  $E$  was the open circuit voltage of the generator the voltage across the load must be  $E/2$  and hence the power absorbed in it is  $E^2/4R$ . This quantity is the power available from the generator, whether we use it by connecting a load of the right impedance or not, and applying the same procedure to a resistance the available noise power is  $4KTBR/4R = KTB$ , and is independent of the ohmic value of the resistance. This is important because it means that the ratio of available signal-to-noise power is not affected by any loss-free impedance transformations which it may be convenient to carry out in the aerial feeders or receiver input circuits.

With a perfect receiver an available signal power equal to  $KTB$  giving unity ratio of signal-to-noise power available from the aerial, should also produce unity signal-to-noise power ratio any-

where in the receiver up to the second detector or whatever may be the first distorting element encountered. Noise-factor of a receiver or amplifier may accordingly be defined as the number of times by which the available signal power from the aerial or other source of signal must exceed  $KTB$  in order to give unity ratio of available signal-to-noise power at the input to the detector, or at the output of the amplifier if this does not include a detector.

It will be observed that the definition requires a measurement of signal-to-noise ratio *before* detection. This is rather important because whereas the characteristics of the detector do not appreciably affect the true sensitivity, as judged for example by ability to detect the presence of weak signals, they *do* influence the ratio of signal-to-noise as read on a meter following the detector. Measurement after detection is usually much more convenient, however, and a simple procedure is described later which permits this to be done provided a noise source is used as the signal generator.

### Definition of Noise Factor

The definition as it stands is not complete, because so far we have avoided discussion of the quantity  $T$ . Now any measurement of sensitivity requires some form of signal generator having an output impedance simulating that of the aerial; since the output impedance is at room temperature it is convenient to use this as a basis for the definition and  $290^{\circ}\text{K}$  is the figure generally agreed, at least in this country. In making signal generator measurements the variations of room temperature are usually too small to be worth considering, but in making practical use of noise-factor figures it is important to appreciate that the "effective temperature" of the aerial for noise purposes may be

<sup>1</sup> H. Nyquist, *Physical Review*, 1928, p. 110.

### Noise Factor—

very different from 290°K. For example, in the case of a microwave radar looking at the sky the aerial noise temperature is only slightly greater than absolute zero. Towards the other extreme, at 7 metres the equivalent noise temperature of an aerial due to radiation from the Milky Way is usually at least 20 times room temperature. In the case of a television receiver, therefore, the receiver can contribute noise equivalent to at least 20 additional room temperature units of aerial noise for a 2:1 loss of effective sensitivity compared with a perfect (noise factor = 1) receiver; in other words it can have a noise factor of 21 times and there is little advantage in striving for much greater perfection. At long wavelengths extra-terrestrial noise is intercepted by the ionosphere and it is only in the range from about 2½ metres up to the wavelength at which the ionosphere becomes effective that the variations of aerial noise temperature are significant.

The representation of noise from the Milky Way as an increase of aerial noise temperature may be no more than a convenient fiction since the noise is probably not of thermal origin. On the other hand the radiation resistance of an aerial has a true thermal noise effect associated with it. Receiving aeriels energized by the passage of a wave re-radiate some of the energy and the power radiated is absorbed sooner or later, either by terrestrial objects or—if the radiation penetrates the ionosphere—perhaps millions of years hence in the depths of space. The appropriate amount of radiation, due to thermal agitation of their electrons, is arriving continually from all objects capable of absorbing radiation and the true noise temperature of the radiation resistance is determined accordingly.

Noise factor may be expressed either as a ratio of powers or in decibels, sometimes one and sometimes the other being more convenient. A good deal of confusion has been caused in the past by expressing it as a voltage ratio and in other conflicting ways,<sup>2</sup>

but the definition given above is now generally agreed although it is often differently worded.

### Energy Bandwidth

In order to complete the definition of noise factor it is necessary to define energy bandwidth. Fig. 1 shows a so-called "ideal" rectangular selectivity curve. A receiver with such a response will amplify all noise energy reaching it between the frequency limits  $f_2$  and  $f_1$  at maximum gain and will be completely dead to all other noise.  $f_2 - f_1$  is therefore the bandwidth of the receiver from the point of view of noise energy.

A much more typical curve for a practical receiver is shown dotted on the same scale and it will be noticed that assuming a uniform noise spectrum, less noise energy will be received between

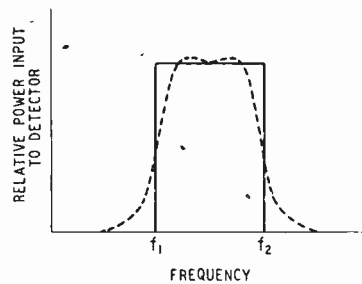

Fig. 1 Equivalent energy bandwidth

the limits  $f_1$  and  $f_2$  but the deficiency will be made up by the response to frequencies outside these limits. If the area under the two curves is the same, then the energy bandwidth  $B$  is the same. The procedure for determining  $B$  is therefore to draw the selectivity curve in the form of relative power input to the detector *versus* frequency, find the area under it (either with a planimeter or by counting squares) and divide by the height at the central (or carrier) frequency. The quotient is the width of the equivalent rectangular response, or in other words the energy bandwidth. Fortunately, there is usually no need to carry out this procedure. If noise factor is measured as described later, with a noise source as the signal generator, it is usually unnecessary

to know the energy bandwidth since the "signal" and the various noise sources are equally dependent on bandwidth and their ratio is not affected by it. Even if a C.W. signal generator is used, it is frequently good enough to assume that the energy bandwidth is equal to the width between half-power points on the response curve, the main exceptions to this being very "peaky" responses, and also the case of a single tuned circuit. The latter has an energy bandwidth equal to  $\pi/2$  times the "3 db down" bandwidth.

### Design of Receivers for Minimum Noise Factor

This is a subject which requires considerable space for adequate treatment and will be dealt with more fully in a forthcoming article. In the meantime reference must be made to one important conclusion. The important part of a receiver from the point of view of noise factor is the first valve and the circuits by which the aerial is coupled to it, because all other sources of noise have less gain after them and can be neglected unless the gain of the first stage is very low. It used to be normal practice to design receiver input couplings for maximum gain, and much of the early confusion on the subject of noise factor has been due to taking this condition for granted. Now maximum gain requires the source impedance to be equal to the input impedance of the receiver, and if we assume for simplicity that this is a resistance at room temperature, it must obviously contribute noise equal to that from the source and the noise factor therefore cannot be better than 2 times, or 3 db. If, on the other hand, the receiver input impedance is so high (compared with the source impedance which is in parallel with it) that it can be regarded as not there, and if at the same time the input coupling can be adjusted to make the source impedance  $R_s$  as seen by the valve so high that its noise voltage (given by  $\sqrt{4KTBR_s}$ ), is large compared with the input voltage equivalent to the valve noise, then the only noise that matters is that from the source

<sup>2</sup> See W. B. Lewis, I.E.E. Radar Convention Paper, "Radar Receivers" for a more detailed discussion.

**Noise Factor—**

and the noise-factor approximates to unity. There is no connection therefore between the circuit design conditions for maximum gain and lowest noise factor, and in fact they must be different! This is not quite true if we abandon the assumption that the receiver input resistance is at room temperature, and at the frequencies and with the circuits usable for radar and television the effective temperature can be anything from just above zero to nearly five times room temperature, but any coincidence between the two conditions is purely accidental. It is now possible to appreciate the definition of noise factor as a ratio of available powers rather than of powers actually supplied; the distinction is not an essential one, since the ratio is not a function of load resistance, but available power is more readily computed, and besides this it helps to emphasize that the signal-to-noise ratio is proportional to the power available and not necessarily to the power used. For a source of resistance R and open circuit voltage E, the available power is given by  $E^2/4R$ .

With typical pentodes, the best noise factors obtainable are of the order of 4.5 db at 7 metres, 3.5 db at 10 metres, and 2 db at 20 metres.

**Noise Factor of Networks in Series**

In the case of very wide band amplifiers, having bandwidths of 20 Mc/s or so, as developed for experimental use with very short pulse-length radar systems<sup>3</sup>, the gain per stage is very low and it becomes necessary to consider the noise from two or more stages. For this purpose, the receiver can be regarded as split up into any convenient arrangement of four-terminal networks having gains  $G_1, G_2, G_3$ , etc., defined as the ratio of power available from the output terminals to the power available from the preceding network, and individual noise factors  $N_1, N_2, N_3$ , etc., expressed as ratios. Then as shown by Früs,<sup>4</sup> subject to all the noise being amplified at the

same bandwidth, the noise factor of the whole receiver is given by 
$$N_R = N_1 + \frac{N_2 - 1}{G_1} + \frac{N_3 - 1}{G_2} + \dots, \text{etc.} \quad (1)$$

The same treatment can be applied to an interesting case which arises in centimetric radar, where the first amplifying valve is preceded by a mixer which usually produces rather more noise than an equivalent resistance at

room temperature, say,  $T_r$  times as much. At the same time, it attenuates the signal by a factor L. Then if  $N_1$  refers to the mixer, and  $N_2$  to the I.F. amplifier we have  $N_1 = LT_r$ , and from (1) we get

$$N_R = L(T_r + N_2 - 1) \dots (2)$$

$T_r$  is known as the noise temperature ratio (N.T.R.) of the crystal mixer, and L as the conversion loss.

**SHORT-WAVE CONDITIONS**

*Expectations for December*

By T. W. BENNINGTON

(Engineering Division, B.B.C.)

DAYTIME maximum usable frequencies for this latitude continued to increase during October, and, as there was relatively little ionosphere storminess during the month, long-distance communication was usually very good, during daytime, on the higher frequencies. On most days, in fact, conditions were such that exceptionally high frequencies could have been used to most parts of the world. The night-time M.U.F.s on the other hand, decreased considerably as compared with September, though the use of the lowest short-wave bands was seldom necessary. These variations were the normal ones due to the seasonal trend in ionisation levels.

October was much less disturbed than September, and only one really severe ionosphere storm occurred. This was during the period 26th-29th, and short-wave conditions were very poor indeed while it lasted. Minor disturbances occurred on 1st, 5th-7th, 20th and 31st.

**Forecast.** — During December there should be a quite considerable decrease in the daytime M.U.F.s, as compared with November, due to what is known as the "mid-winter effect" in the Northern Hemisphere. M.U.F.s will, however, still be high enough to permit of communication on the higher frequencies over most circuits for considerable periods, though the duration of such periods will be considerably less than during November. The night-time M.U.F.s will continue to decrease, in fact, they will be lower than for some long time past. Night-time working frequencies will remain operative over most circuits for a longer period than during November. Though frequencies as low as 7 Mc/s will be necessary for maintaining long-distance communication over many circuits for long periods, it is not expected that fre-

quencies much lower than this will often be really necessary.

Below are given, in terms of the broadcast bands, the working frequencies which should be regularly usable during December for four long-distance circuits running in different directions from this country. In addition, a figure in brackets is given, which indicates the highest frequency likely to be usable for about 25 per cent of the time during the month for communication by way of the regular layers:—

<b>Montreal :</b>	0000	9 Mc/s	(13 Mc/s)
	0100	7 "	(11 " )
	1100	11 "	(15 " )
	1200	17 "	or 21 Mc/s (28 " )
	1400	26 "	(35 " )
	1700	21 "	(29 " )
	1900	17 "	or 15 Mc/s (21 " )
	2100	11 "	(19 " )
	2200	9 "	(14 " )
<b>Buenos Aires:</b>	0000	9 "	(14 " )
	0400	7 "	(12 " )
	0800	11 "	(16 " )
	0900	17 "	or 21 Mc/s (28 " )
	1100	26 "	(34 " )
	1800	21 "	or 17 Mc/s (28 " )
	2000	11 "	(16 " )
	2200	9 "	(15 " )
<b>Cape Town :</b>	0000	9 "	(14 " )
	0800	11 "	(17 " )
	0700	21 "	(30 " )
	0800	26 "	(36 " )
	1600	21 "	or 17 Mc/s (28 " )
	1800	15 "	(18 " )
	1900	11 "	(16 " )
	2000	9 "	(15 " )
<b>Chungking :</b>	0000	7 "	(11 " )
	0400	9 "	or 11 Mc/s (14 " )
	0600	15 "	or 17 Mc/s (20 " )
	0800	21 "	(30 " )
	1100	17 "	(26 " )
	1200	11 "	(17 " )
	1300	9 "	(14 " )
	2000	7 "	(11 " )

Ionosphere storms which may occur during December are likely to be particularly troublesome during darkness, for the ionisation of the reflecting layers will in any case be low at that time in the Northern Hemisphere, and any further abnormal decrease may well interrupt communications. Although one cannot be at all certain it would appear at the time of writing that such disturbances are more likely to occur within the periods 2nd-3rd, 13th, 19th-22nd, and 27th-30th than on the other days of the month.

<sup>3</sup> W. B. Lewis, *loc. cit.*  
<sup>4</sup> *Proc. I.R.E.*, 1944, p. 419.

## TEST REPORT

## MURPHY A104

Table Model Receiver  
for A.C. Mains

Four Valves  
+  
Rectifier



## WAVE RANGES :

Short: 16 - 52 metres.  
Medium: 200 - 550 metres.  
Long: 1,000 - 2,000 metres.

Price: £25 plus £5 11s. 1d. tax

THE basic idea behind the unconventional form of this set is that a flat baffle is acoustically better than a box cabinet, since there is no partially enclosed volume of air which might give rise to unwanted resonances. The size of the baffle is 24in x 18in, and the depth from back to front is only 6½in. Quality is good in any position provided that the set stands on a firm base, for the loudspeaker is mounted near the bottom of the baffle in

order to make use of the additional area of the surface upon which it stands.

In this receiver it is intended that the short-wave range shall make a significant contribution to the entertainment value of the set, and to this end an optically projected "bandspread" scale has been provided which is one of the best we have so far seen.

Circuit. — Basically the four-valve superheterodyne circuit is of the simplest character, and it is to the detail design of components that we must look for any distinguishing qualities of performance.

The I.F. transformers are the heart of the set, and these are of a new design developed for use in many of the post-war Murphy sets. They make use of high-inductance windings tuned by silvered-mica condensers with low temperature coefficient and the cores are adjusted by bakelite screws to cut down eddy current losses.

A temperature compensating condenser is connected in parallel with the oscillator section of the main condenser to minimise tuning drift. Bandspread tuning on the short-wave range is effected by moving a brass plunger relative to the oscillator coils. The small variation of inductance thus

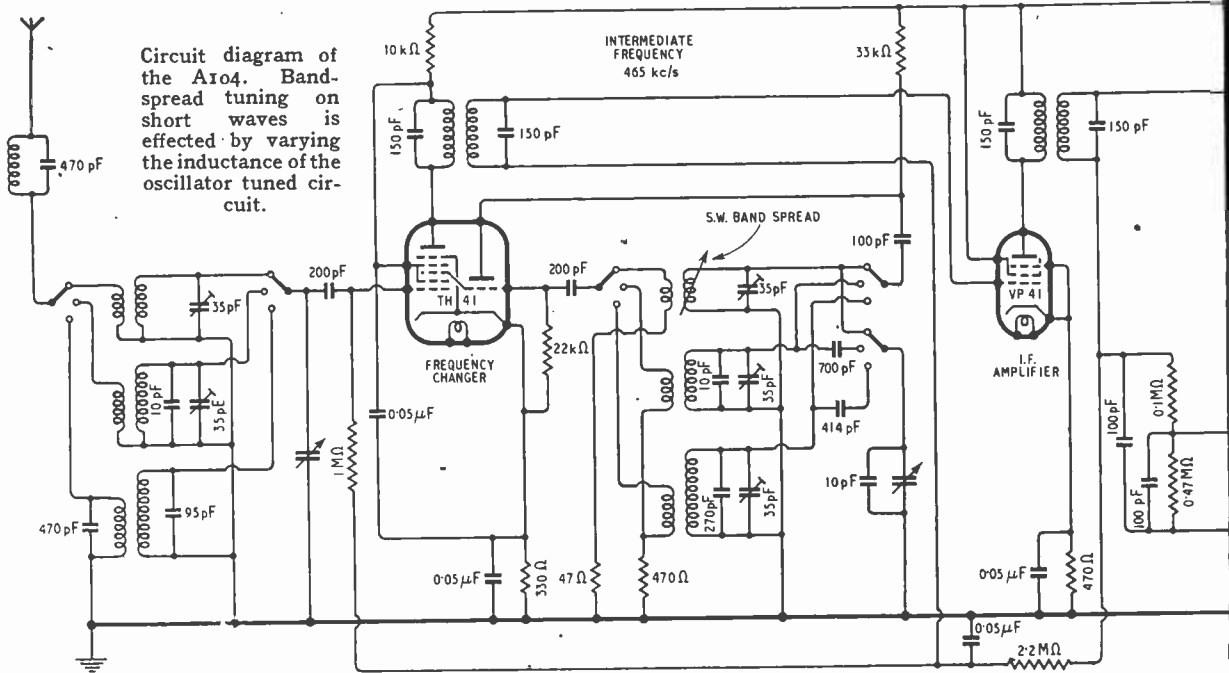

effected is available at any part of the range.

**Performance.**—To an ear accustomed to conventional cabinet receivers the first impression of the quality from the A104 will be one of preponderant middle and top frequencies. This is due to the absence of the broad resonance in the region of 150 c/s which is often used to give the impression of good bass response. Quality enthusiasts will not require to be told that a well distributed bass is always unobtrusive; they will have no difficulty in recognising the unrestricted mobility of the lower-toned instruments of the orchestra when heard through this receiver. The response appears to be uniform down to about 70 to 80 c/s, and at the other end up to about 6,000 c/s, above which there is a gradual tail-off. Judging by the selectivity, which is above average for a four-valve superheterodyne, we would say that the A.F. response is well adapted to make full use of the range of frequencies available through the band-width of the I.F. stage. In the absence of "boom" it is easier to turn up the volume to levels near the overload point of the output stage, but the threshold is fairly well defined, and one soon finds the compromise level which gives,

without distortion, the bass response the ear demands.

The sensitivity is high on all three waveranges and the short-

narrow chassis running the full width of the baffle gives a logical layout of components in circuit sequence.

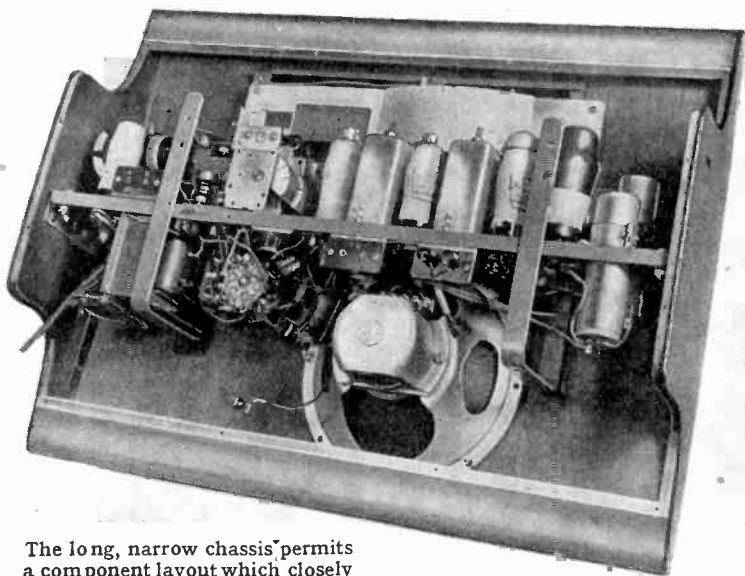

The long, narrow chassis permits a component layout which closely follows the circuit diagram.

wave performance is particularly lively. The magnified bandspread tuning scale makes operation on the short waves as easy as on the long, and allows accurate logging over the whole range.

**Constructional Details.**—A long,

The short-wave tuning scale is photographed on a semi-circular glass plate mounted directly on the rotor of the main tuning condenser. An image of a section of the scale covering the width of any of the broadcast bands is projected on to a ground glass screen on the front panel, giving a magnified total scale length of 50in. Behind the screen is a pointer, coupled to the bandspread tuning plunger in the oscillator coil, which moves independently over the image of the main scale. The optical magnification of the main scale and the electrical "magnification" of the bandspread circuit are the same, so even if any particular section of the main scale is not accurately centred on the screen, the pointer always registers on the same part of the scale image for any given station, and settings which have been logged can always be repeated. In the majority of bandspread systems the setting of the fine tuning control is arbitrary, or bandspreading is confined to the principal broadcast bands; in the Murphy system accurate repetition of readings with bandspread magnification is available from end to end of the range.

**Makers.**—Murphy Radio, Ltd., Broadwater Road, Welwyn Garden City, Herts.

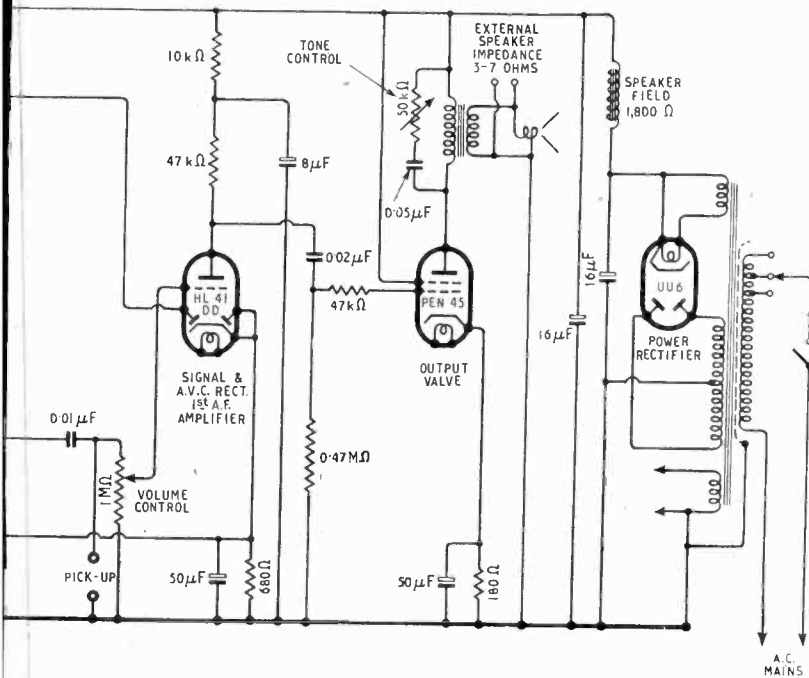

## PARALLEL STANDARD RESISTORS

### Tabulated Values of Parallel Combination of Standard Resistors

IT is frequently necessary in experimental and development work to pick two or more standard-value resistors for parallel connection to obtain a required value, or, conversely, to determine the effective resistance of two or more standard values.

The accompanying table is quicker and easier to use than the slide rule or abacs, with both of which a little care and time are required to find the standard numbers. Rapid comparison between several resistor pairs approximating to any required value can also be made.

The table covers nearly two decades of values common to the 10 per cent and 5 per cent tolerance group; those shown in heavy type are also available in the 20 per cent group. Intermediate 5 per cent tolerance group values can be interpolated at a glance without appreciable error by mentally taking the arithmetic mean of adjacent values. In most cases the resistors involved will be in the same decade and the top right-hand half of the table will be used. The lower left-hand portion covers adjacent decades with the higher values running horizontally and the lower vertically.

Two examples will be given to show the use of the chart.

(i) A 170-ohm bias resistor is required and the nearest standard value is not available. It is desired to make up the required value by parallel connection of higher values.

A glance over the table shows that four pairs of values give an approximation within 5 ohms, viz., 470, 270 (171); 820, 220 (173); 680, 220 (166); 330, 330 (165).

(ii) It is required to find the effective value of 22 k $\Omega$  and 51 k $\Omega$  (a 5 per cent value) in parallel. The chart shows that 22 k $\Omega$  and 47 k $\Omega$  give 15.0 k $\Omega$ , while 22 k $\Omega$  and 56 k $\Omega$  are equivalent to 15.8 k $\Omega$ . Interpolating, we get for the given values an effective resistance of 15.36 k $\Omega$ , say 15.4 k $\Omega$ .  
A. K. W.

## COMMUNICATIONS TYPE BROADCAST RECEIVER

### Peerless Model 1546 Radio Chassis

ALTHOUGH intended for normal broadcast reception this new Peerless receiver embodies many features usually found only in the communications type of set. For example, it includes a B.F.O. for C.W. reception, a crystal filter in the I.F. amplifier and in addition to the normal medium and long-wave broadcast bands there are three short-wave bands giving a continuous coverage from 3 to 60 Mc/s. Thus it takes in the television sound programme.

The circuit used is a superheterodyne having no fewer than 15 valves (+ rectifier) and a voltage stabiliser.

The input circuit is unusual for a present-day receiver in that there is a band-pass filter before the R.F. amplifier, thereby providing four

tuned circuits at signal frequency ahead of the frequency changer. Second-channel rejection should, therefore, be very good even on the short-wave bands.

A triode-hexode, but with a separate oscillator valve, forms the frequency changer and this is followed by two stages of I.F. amplification at 465 kc/s and allowing the choice of two bandwidths. One, with the crystal filter in, gives a bandwidth of 3 kc/s and the other a peak separation of 5 kc/s. Iron dust cored transformers are used in the I.F. amplifier.

Special attention has been given to providing a good A.V.C. performance and an amplified system is employed with which is embodied an inter-station noise silencer; this is a useful feature in a receiver of such high sensitivity as this new Peerless model. The only figure so far available regarding this characteristic of the set is that a 2 $\mu$ V signal modulated at 30 per cent gives an A.F. output at 400 c/s of 50 milli-watts.

The unusually large power output of 20 watts maximum, with a total harmonic content not exceeding 2 per cent, is provided by a pair of 6L6 valves in push-pull and with negative feedback. This output stage is preceded by a driver and phase reversing stage consisting of a double triode. Volume control and a tone control precede this stage and at this point in the circuit the radio and gramophone channels meet; thus the tone control is effective on both types of reproduction.

Other features of the set include a mechanical band-spread for short-wave tuning, and full tropicalization of all components.

The overall size of the chassis is 19in x 14in x 11in and the price is £50 8s, plus £11 10s purchase tax.

The set is made by Peerless Radio, Ltd., and distributed by Telemechanics, Ltd., 374, Kensington High Street, London, W.14.

← SAME DECADE →													
$\Omega$	10	12	15	18	22	27	33	39	47	56	68	82	$\Omega$
10	5.00	5.46	6.00	6.43	6.88	7.30	7.68	7.96	8.25	8.49	8.72	8.91	10
12	10.7	6.00	6.67	7.21	7.78	8.31	8.70	9.19	9.56	9.89	10.2	10.5	12
15	13.0	13.3	7.50	8.19	8.93	9.65	10.3	10.8	11.4	11.8	12.3	12.7	15
18	15.3	15.7	16.1	9.00	9.90	10.8	11.7	12.3	13.0	13.6	14.2	14.8	18
22	18.0	18.6	19.2	19.6	11.0	12.1	13.2	14.1	15.0	15.8	16.6	17.3	22
27	21.2	22.0	22.8	23.5	24.0	13.5	14.8	16.0	17.1	18.2	19.3	20.3	27
33	24.8	25.9	27.0	27.9	28.7	29.4	16.5	17.9	19.4	20.8	22.2	23.6	33
39	28.0	29.4	31.0	32.1	33.1	34.1	34.9	19.5	21.3	23.0	24.8	26.4	39
47	32.0	33.8	35.8	37.3	38.7	40.0	41.2	42.0	23.5	25.6	27.8	29.9	47
56	35.9	38.2	40.8	42.7	44.7	46.4	47.9	49.0	50.0	28.0	30.7	33.3	56
68	40.5	43.4	46.8	49.3	52.0	54.3	56.4	57.9	59.4	60.6	34.0	37.2	68
82	45.1	48.7	53.0	56.3	59.7	62.9	65.7	67.7	69.9	71.5	73.2	41.0	82
$\Omega$	100	120	150	180	220	270	330	390	470	560	680	820	$\Omega$

↑ LOWER  
ADJACENT DECADES → HIGHER



# BRIMAR



*contacts*

# DREAMBOAT

**T**WO-WAY telephony contact with the American Superfortress "DREAMBOAT" before it reached England was made at 18.40 hrs. on Saturday, October 5th, 1946, by Mr. W. T. Pickard (G8KP) of Wakefield, Yorkshire, using BRIMAR VALVES. At the time of the contact "DREAMBOAT" was airborne over Iceland on her non-stop flight from Honolulu via the North Pole to Egypt. Mr. Pickard talked with "DREAMBOAT'S" officer (Frank Shannon) for 17 minutes. To quote Mr. Pickard's words: "Reception both ways was equal to local B.B.C. transmissions."



*Another Triumph  
for*

**BRIMAR**  
(BVA)  
**VALVES**

STANDARD TELEPHONES AND CABLES LIMITED, FOOTSCRAY, KENT

It's easy to make Pick-ups  
— if you know how.  
The know-how in the manufacture of  
**Lexington**  
MOVING COIL PICK-UPS

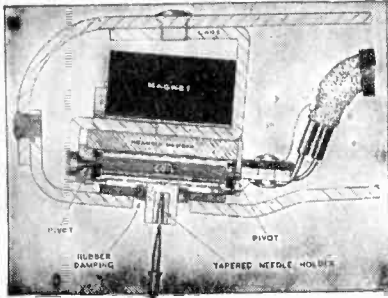

is the result of long experience and precision watch-making standards which give a finely constructed instrument the details of which are shown in the sectional diagram.

**DE LUXE MODEL** ● Robust design. Accidental dropping on record will not damage Pick-up ● Extremely low moment of inertia (80 milligrams total weight of movement) ● Pure sine wave with no harmonic distortion ● Automatic needle or sapphire changing opens new fidelity field to the amateur ● Can be used with normal record changer without fear of damage.

Price (without sapphire) £5 plus 25/- P.T.

Sapphire Needle with specially tapered shank, price 15/3 extra (including P.T.)

**JUNIOR MODEL.** Identical in design and workmanship to the De Luxe, the only difference being that it is not equipped with the Automatic Sapphire needle inserter and Extractor device, and metal sole plate. Made to take standard steel and fibre needles this model enables every music lover to enjoy the fine reproduction which only a moving coil pick-up can give. £3. 3. 0 plus 15/9 P.T.

See November issue for Curve of Pick-ups

● **PLUG-IN HEADS** ●



These are available in both Junior and De Luxe types to fit Collaro and Garrard arms, thus providing easy change-over from Magnetic types. Input conversion may be required. (See our Technical Brochure). Price 45/-, plus 11/3 P.T.

Separate Ejector for De Luxe type, 28/-, plus 7/- P.T.

● **COMPLETE MOVEMENTS** ●

(as per illustration) are also available from stock for converting existing standard pick-up heads. 38/-, plus 9/6 P.T. (De Luxe type requires Ejector as above.)

● **PRE-AMPLIFIERS** ●

having an inverse of the recording characteristic incorporated are available for use with pick-ups. These are necessary with some amplifiers.

Illustrated Technical Brochure upon request.

Export and Trade Enquiries invited.

Obtainable through your local Dealer.

**COOPER MANUFACTURING CO.**  
134, WARDOUR STREET, LONDON, W.1

Phone: GERrard 7950

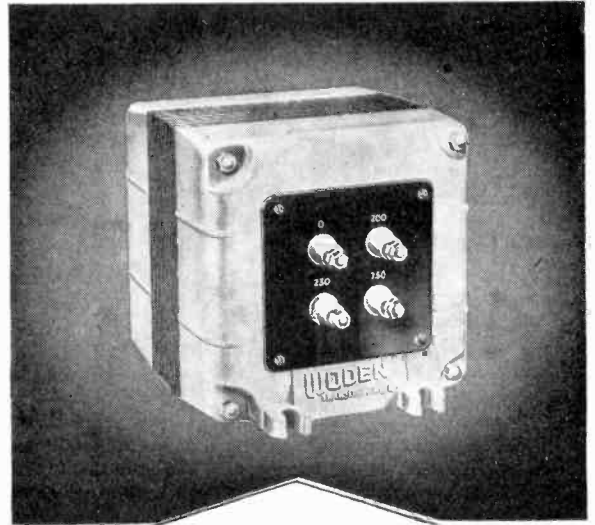

HERE IS THE NEW  
**TRANSFORMER**  
THAT HAS *Everything!*

- SUPERB TECHNICAL DESIGN
- FINEST QUALITY MATERIALS
- HIGH OPERATIONAL EFFICIENCY
- GUARANTEED RELIABILITY
- BEAUTIFUL APPEARANCE

BRIEF DETAILS OF THE RANGE . . . .  
Mains Transformers, 5—5,000 Watts; Input and Output Transformers: Filter Chokes.

. . . . AND OF THEIR CONSTRUCTION

High Quality Silicon iron laminations; wire to B.S.S. Standards; finest grade insulation; Die Cast Streamline Shrouds; Black bakelite Terminal panels; High Vacuum Impregnated coils layer wound with condenser tissue interleaving; Porcelain terminals insulated and/or silver plated soldering tags.

**WODEN** *de Luxe*  
**TRANSFORMERS**

WODEN TRANSFORMER CO. LTD.,

MOXLEY ROAD, BILSTON, STAFFS.

Telephone: BILSTON 41959

# NOISE LIMITERS

## Mitigating Ignition Interference in the Receiver

By H. B. DENT

THE inclusion of a noise limiter in the communication receiver goes a long way towards mitigating the nuisance caused by motor car ignition systems. This form of interference is particularly troublesome on the five-metre amateur band, where most of the really interesting DX signals are generally not more than three or four "R" strengths above the background noise.

From time to time various simple noise suppression circuits have been described, but the most that the majority do is to limit the signal, and the noise, to a predetermined level.

A limiter that automatically adjusts itself to the carrier strength and decapitates all noise impulses rising above the 100 per cent modulation level has certain attractions.

One that behaves in this fashion is the Dickert noise limiter shown in Fig. 1. Given the right conditions it can be quite effective and, moreover, it is very economical so far as parts are concerned.

Various explanations have been given of the manner in which it functions, but the following description appears to be the most likely one. When a carrier is tuned in the rectified current flowing in the diode load, here represented by  $R_1$   $R_2$ , produces a steady voltage across the load such that the point A is negative with respect to the earth line. If the carrier is fully modulated this voltage will fluctuate between zero and twice this steady voltage.

The diode load, being divided into two equal parts, for  $R_1 = R_2$ , the point B, and hence the cathode of the noise diode  $V_1$ , will vary in potential from zero to half the peak voltage at A.

Now if the network  $R_3$   $C_3$  has a sufficiently long time constant the anode of  $V_1$  will not be able to follow the modulation, but will

assume a potential equal to the mean negative voltage at A. This approximates to the voltage at that point in the absence of modulation.

Thus for all signal amplitudes up to 100 per cent modulation the cathode of  $V_1$  never becomes more negative than its anode and the valve does not conduct.

When a strong impulse of noise is received the point A instantly becomes very negative, B tends to follow the change, but as C remains unaffected, the time constant of  $R_3$   $C_3$  preventing a rapid change,  $V_1$  conducts and the potential at B falls to that at C. As the A.F. signal is taken from the cathode of  $V_1$ , and hence the point B, the noise impulse is very considerably reduced in amplitude. If  $V_1$  responds quickly enough, and has a reasonably low impedance when in the conducting state, the amplitude of the noise may not exceed the normal carrier level.

The interference produced by the ignition system of motor cars is of a peaky staccato kind, particularly suitable for operating a noise limiter; moreover, its duration is very short—50  $\mu$ sec. or so.

It is the short duration of these noise impulses that makes it possible in practice to whittle down the interference, and if the noise becomes unduly lengthened in its passage through the receiver the effectiveness of the limiter will be correspondingly impaired.

This may occur if the receiver

circuits are very peaky or there is excessive regeneration, intentional or otherwise, since the low decrement of the circuit will then prolong the duration of the impulse.

Whilst the shunt limiter can be quite effective in the right setting it is possible to effect a considerable improvement by introducing another diode, operating in conjunction with the shunt diode, but included in the A.F. signal path. This circuit is given in Fig. 2.

For signals up to 100 per cent modulation the series diode  $V_3$  is conductive, since in this case its cathode potential is maintained more negative than its anode, while the shunt diode remains just non-conductive.

On the arrival of a strong impulse of noise these conditions reverse, for the anode of  $V_3$  is driven suddenly very negative and the valve cuts off. The primary function of  $V_1$  in this circuit is to

Fig. 1. Theoretical circuit of the Dickert shunt-type noise limiter which follows the mean carrier level.

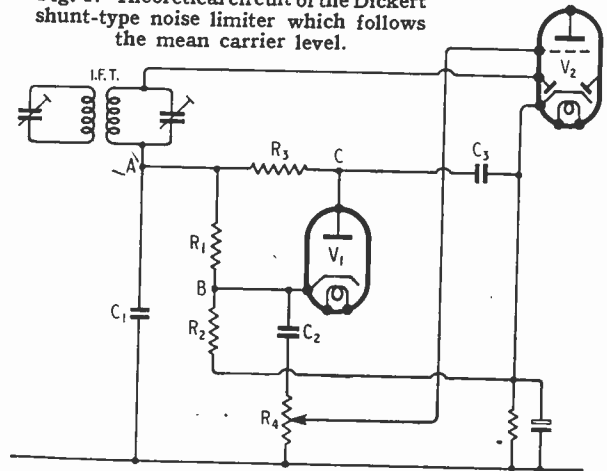

maintain the cathode of  $V_3$ , so far as possible, at a potential equal to that at the anode of  $V_1$ .

This double triggering action gives far more effective noise suppression than a single valve and, moreover, it functions well in most types of communication receiver, provided the band width is not too narrow, or where the shunt diode alone fails to provide a worthwhile improvement.

In Fig. 2 the series and shunt diodes are drawn as separate

**Noise Limiters—**

valves in order that the resemblance to Fig. 1 can be readily seen. In practice, however, these two can be in one envelope, as in the usual receiving type double diode.

As the signal diode load has to be centre-tapped for these noise limiters there is a corresponding loss in signal strength as the output is then taken from only one half of this load. A little more A.F. amplification is, therefore, desirable and in many cases this can be effected simply by changing the valve  $V_3$  for one having a triode section affording a higher gain. Suitable changes in the anode and cathode resistors may also be required.

Where practicable, however, a better way of recovering the lost amplification is to improve either the I.F. or R.F. gain. The latter is usually the more convenient as it can be effected by adding a self-contained unit, which might well take the form of a wide-band R.F. amplifier of two or three stages covering 56 to 60 Mc/s. This will take in any possible foreign stations using that part of the five-metre band not open to British amateurs. The advantage of this type of pre-amplifier is that no additional tuning controls are involved.

As a temporary alternative a switch can be included in the noise limiter circuit to put it out of action when there is no interference present. A single-pole change-over switch, as shown in Fig. 2, will serve this purpose.

A further refinement is to subdivide  $R_1$  into two parts, shown as  $R_{1a}$  and  $R_{1b}$ , respectively thereby enabling  $R_{1a}$  to be used as a R.F. filter in conjunction with  $C_1$  and  $C_4$  when the noise limiter is not required.

**CERAMIC SWITCHES**

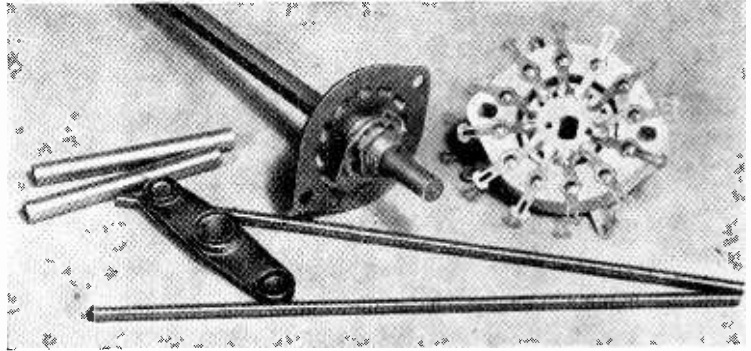

Wearite ceramic wafer switch and accessories.

**W**AFER switches of the type commonly used for coil switching, but with ceramic insulation, are now available in a new and more compact design. Plates are of Frequentite, with silver-copper contacts; the switches should be particularly useful for low-loss switching in all types of high-frequency apparatus, including short-wave receivers.

Each wafer has 12 fixed contacts and from one to four selection contacts so that combinations of 12-way 1-pole, 6-way 2-pole and 3-way 4-pole are available; there is no 3-pole type in the standard range, but any combination can be obtained by using two or more of these three types.

Switch wafers cost 7s each, the index mechanism 4s, while spacers, side rods, locating strips and other accessories are priced according to size. They cost only a few pence each.

These switches are made by Wright and Weaire, Ltd., 740, High Road, Tottenham, London, N.17, and for retailers, research and experimental establishments they are distributed in steel chests containing 150 assorted switch wafers, 75 index mechanisms and an appropriate quantity of other accessories

Fig. 2. This circuit also follows the mean carrier amplitude but the additional series diode  $V_3$  renders it far more effective in practice. Circuit values are:— $C_1$ , 50pF;  $C_2$ , 0.01 $\mu$ F;  $C_3$ , 0.5 $\mu$ F;  $C_4$ , 100pF;  $R_{1a}$ , 22k $\Omega$ ;  $R_{1b}$ , 47k $\Omega$ ;  $R_2$ , 68k $\Omega$ ;  $R_3$ , 470k $\Omega$ ;  $R_4$ , 1M $\Omega$  potentiometer;  $R_5$ , 1M $\Omega$ .

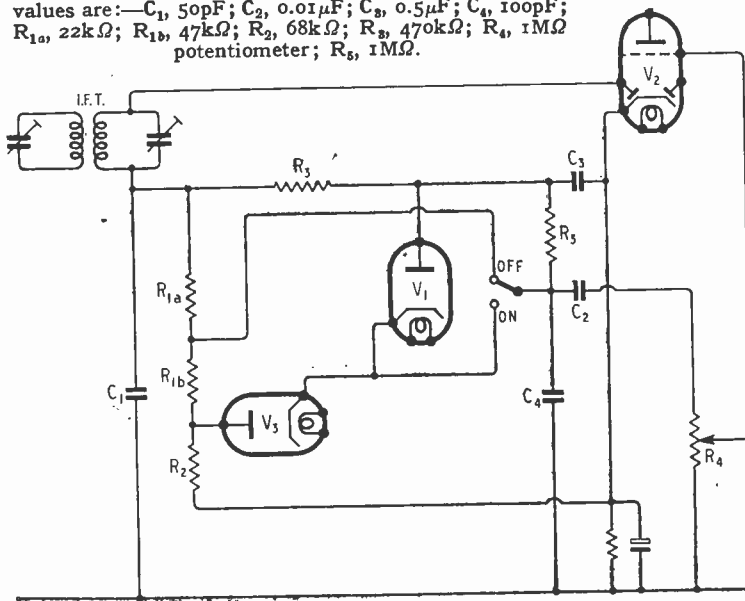

**SOLDER IN CARTONS**

**T**O cater for needs intermediate between those of the large-scale manufacturer and the handyman, Multicore solder is now available in cartons ("Size One") measuring 2in x 2in x 3in and containing lengths from 36 to 151ft, depending on the gauge. The wire is coiled in such a way that it can be pulled through a hole in the lid without kinking. Windows in the side enable the user to see the amount remaining in the carton.

The makers are Multicore Solders, Mellier House, Albemarle Street, London, W.1. High-tin 60/40 radio-quality alloy is available in 14 S.W.G. (56ft at 6s) and 18 S.W.G. (151ft at 6s 9d).

# World of Wireless

## B.B.C. STATIONS

**D**URING the past few months a number of letters have appeared in *Wireless World* on the secretiveness of the B.B.C. regarding the location of its stations. We are now able to give details.

In giving us the information the B.B.C. states that it has not previously publicised the details of its distribution scheme "partly for security reasons (our italics) and partly because of the temporary and changing nature of so many factors," some of which still exist and may necessitate changes being made.

The transmitters radiating the Home Service are:

kc/s	Station	Service	kW
668	Moorside Edge, near Huddersfield	Northern	100.0
767	Burghead, Moray-shire.	Scottish	60.0
767	Redmoss, near Aberdeen.	"	2.5
767	Westerglen, near Falkirk.	"	60.0
804	Penmon, Anglesey	Welsh	10.0
804	Washford, Somerset.	"	60.0
804	Wrexham, Denbigh	"	1.0
877	Brookman's Park	London	100.0
977	Start Point, S. Devon.	West of England.	100.0
1,013	Droitwich, Worcestershire.	Midland	60.0
1,013	Norwich, Norfolk	"	1.0
1,050	Lisnagarvey	N. Ireland	100.0
1,050	Londonderry	"	1.0
1,050	Stagshaw, North-umberland	Northern or N. Ireland.	100.0
1,384	Bartley, Hampshire.	West of England.	10.0
1,384	Clevedon, Somerset.	" "	20.0

In addition to the 150-kW Droitwich transmitter on 200 kc/s, the following transmitters radiate the Light Programme on 1,149 kc/s; Brookmans Park, 60 kW; Moorside Edge, 60 kW; Westerglen, 60 kW; Burghead, 20 kW; Lisnagarvey, 10 kW; Stagshaw, 10 kW; Redmoss, 2 kW; Redruth, Cornwall, 2 kW; Plymouth, Devon, 1 kW; and Londonderry, 1 kW.

The Third Programme is radiated by the 25-kW Droitwich transmitter on 583 kc/s, and the synchronized group of stations on 1,474 kc/s. These stations, the power of which varies according to the size of town to be served, are in Belfast, Bournemouth, Brighton, Bristol, Cardiff, Dundee, Edinburgh, Fareham, (Hants), Glasgow, Leeds, Liverpool, London — Balham, Manchester, Middlesbrough, Moorside Edge, Newcastle-on-Tyne, Preston (Lancs), Plymouth, Redmoss, Sheffield.

Only two of the three stations used for the European Service are in this country, the third is in Norden, Germany. This 100-kW trans-

mitter radiates on 658 kc/s. The other two stations are at Ottringham, near Hull (167 kc/s) and Crowborough, Hants (1122 kc/s).

## N. AMERICAN AMATEUR BANDS

**T**HE A.R.R.L. announced from its headquarters' station, W1AW, on November 2nd, that the F.C.C. had restored the full widths of the 20- and 40-metre bands—14.0-14.4 and 7.0-7.3 Mc/s — for U.S. amateurs.

The additional frequencies are at the moment for C.W. only. The question of allowing phone in the 40-metre band and also of extending the present phone portion of the 20-metre band (14.2-14.3 Mc/s) is being considered.

Canada has also restored the two bands, but permits phone from 14.15-14.30 Mc/s.

## RADIO CONTROL

**I**T was announced in April that P.M.G. had allocated the frequency of 460.5 Mc/s for the radio remote control of models. It is now learned that in addition the 27.66-28 Mc/s band has been allocated.

It is interesting to note that, whilst the new band is provisional, "frequencies that may be definitely assigned for this purpose at a later date will be, so far as can be seen at present, of the same order."

## BRIT. I.R.E. COMES OF AGE,

**A** DINNER was held at the Savoy Hotel, London, on October 31st, 1946, to celebrate the 21st anniversary of the British Institution of Radio Engineers, at which some 300 members and guests were present. In replying to the toast of the President, proposed by the immediate past-president, Leslie McMichael, the new president,

Admiral the Viscount Mountbatten of Burma and the Earl of Listowel, the Postmaster-General, at the Brit. I.R.E. coming-of-age dinner. G. D. Clifford, general secretary of the Institution is seen talking to Viscount Mountbatten

ing the human brain. He pointed out that many of the functions of the brain are largely automatic and stressed the similarity with certain electronic calculating machines. He envisaged a big future for this branch of electronics.

The present Institution has grown out of the original Institute of Wireless Technology and the Institution of Radio Engineers, which were formed in 1925 and 1933, respectively, and which combined to form the Brit. I.R.E. in 1941.

## FREQUENCY ALLOCATIONS

**I**T has been agreed at the five-power telecommunications conference, which was held in Moscow in October, to ask the United States Government to convoke a World Telecommunications Conference next year.

The Soviet Vice-Minister for Communications states that the Committee appointed by the Conference to investigate the problem of frequency allocations which was presided over by Sir Stanley Angwin—head of the British delegation—had been able to settle "less than half the frequencies having international significance, in spite of three weeks' work." It is understood the greatest measure of agreement was reached regarding proposals for European allocations.

## TECHNICAL DIRECTION

**A** SUMMARY of the first year's work of the Technical Directive Board of the Radio Industry Council, of which T. E. Goldup (Mullard) was the first chairman, was recently issued by the R.I.C.

It was formed in July, 1945, to act in an advisory capacity to the Council and its ten members represented the four constituent associa-



## World of Wireless—

tion of the R.I.C.—B.R.E.M.A., R.C.E.E.A., B.R.V.M.A. and R.C.M.F.

By co-ordinating the technical views of the various sections of the industry it was able to further the work which is being undertaken on valve standardization. Another question with which the Board has been concerned, in collaboration with the British Standards Institution, is that of standardizing radio apparatus in matters affecting the user.

The Board has maintained close relations with the I.E.E. regarding the proposed regulations for the electrical equipment of ships, in the preparation of Codes of Practice—including those on radio interference, and the arrangement of the discussion meetings of the Radio Section of the Institution.

In the field of marine radar the Board has been actively concerned in the decision as to the best wavelength (3 cm) to be adopted for general-purpose navigation.

The Board's chairman for the current year is C. S. Agate (E.M.I.).

## B.S.R.A.

**M**EMBERS of the British Sound Recording Association visited the laboratories and works of the M.S.S. Recording Co., Poyle Close, Colnbrook, on October 30th and spent an instructive afternoon seeing the organization behind the production of recording discs, cutter heads, sapphires and complete recording machines. In the studio a series of direct recordings were made to demonstrate the effect of the directional characteristics of microphones and the importance of being able to adapt the overall performance to the conditions under which a record was made and reproduced.

The membership of the Association is rapidly increasing and regular monthly meetings for lectures and discussions are being arranged for the New Year. Leaflets setting out the objects of the Association are obtainable from the Hon. General Secretary, B.C.M./B.S.R.A., London, W.C.1.

## RADAR FILM

**A**LTHOUGH it is not a documentary film, "School for Secrets," which had its *premiere* at the Odeon, Leicester Square, London, on November 7th, will give the layman—and the laywoman—some idea of the development of British radar and its operational applications. The film, which will be generally released on January 6th, centres around five "Boffins" working on "the secret a million kept."

## RECEIVER SPECIFICATIONS

**C**ONDENSED technical specifications of 138 broadcast receivers made by some 55 British manufacturers are contained in a handy little 24-page booklet issued by our publishers, Iliffe & Sons, Ltd. The information, which is correct up to October 29th, was compiled by our associated journal *The Wireless and Electrical Trader*, and gives such details as valves employed, I.F., wavebands, output, power supplies, provision for external loudspeaker and pickup, and price.

Copies of this useful reference booklet are obtainable from book-stalls, price ninepence.

## PERSONALITIES

**Vice-Admiral J. W. S. Dorling**, C.B., director of the Radio Industry Council, has had the Legion of Merit, Degree of Commander, conferred on him by the President of the United States for services on various bodies in the U.S. during the war.

**D. A. Bell, M.A., B.Sc.**, a contributor to both *Wireless World* and our sister journal, *Wireless Engineer*, has left A. C. Cossor, Ltd., and joined the recently formed British Telecommunications Research, Ltd., of which Dr. T. Walmsley, C.B.E., is director and chief engineer.

**M. I. Lipman, M.B.E.**, has relinquished his position as general manager of E. K. Cole's Special Products Division, which includes car radio production.

**H. L. Oura, M.B.E., B.Sc.**, has taken charge of E. K. Cole's Western Development Unit at Malmesbury, Wilts. He has been with the Gramophone Company for many years and was, immediately prior to his present appointment, a director of E.M.I. Engineering and Development, Ltd.

## IN BRIEF

**Components Exhibition.**—Next year's "private" exhibition of radio components and accessories, arranged by the Radio Component Manufacturers' Federation, will be held at the new Royal Horticultural Hall, Greycoat and Elverton Streets, London, S.W.1, from March 10th to 13th. Further details will be announced later.

**Amateur "Centimetrics."**—The P.M.G. has announced the release of the 2,300-2,450 Mc/s band for the use of amateurs. Input power is limited to 25 watts. F.M., but not pulse, transmission is permitted.

**New Call Signs.**—Amateurs in parts of the United Kingdom other than England *must* now use an additional letter following the standard letter G; it is no longer optional. The allocations are:—Scotland, M; Wales, W; Northern Ireland, I; Channel Islands, C. Amateurs in Monmouth are given the option of adopting the letter W.

**Dumped.**—In reply to questions in the House of Commons the Minister of Supply stated that 3,600 receivers and 5,700 transmitter-receivers had been dumped in disused pitshafts at Cheadle, Staffs, "since they were unserviceable and not economically repairable and their value for civilian purposes was negligible."

**American amateurs serving with the U.S. Forces in France** are now permitted to operate stations and are assigned calls in the French group F7AA to F7ZZ. Operating conditions are similar to those in the U.S. Zone of Germany.

**WIAW.**—The revised operating schedule for the A.R.R.L. station which transmits the League's official bulletins giving information on amateur activities in the States, is:—

Tues.-Sat., 0100-0430 G.M.T.  
Sun., 0600—Mon., 0100 G.M.T.  
The frequencies employed for C.W. are 3.555, 7.145, 14.150, 28.060 and 52 Mc/s and for 'phone 3.950, 7.145, 14.280 and 52 Mc/s.

**Jubilee.**—To mark the jubilee of the opening of the Northern Polytechnic on October 5th, 1896, the Governors have issued an illustrated brochure and organized an exhibition of students' work. It is recorded in the brochure that during the war over 2,000 Service trainees took courses in radio, cinematography and allied subjects in the radio section of the school started in 1929. Dr. T. J. Drakeley has been principal since 1932.

**Television licences** totalled 3,350 at the end of October, when the number of licences (broadcast and television) in Gt. Britain and Northern Ireland totalled 10,706,000. It should be pointed out that the television figure does not represent the number of sets in use, as viewers holding unexpired 10s broadcast licences do not have to take out a television licence until their ordinary receiving licence expires.

**Motorists** are reminded by the P.M.G. that it is necessary to take out a separate receiving licence for a set installed in a car.

**514 Metres.**—An error unfortunately crept into our note on this wavelength in the October issue. The 50-kW Madona station was not destroyed by the Germans and was, in fact, in operation until at least the end of 1944.

**B.K.S. Library.**—The British Kinematograph Society has now opened a library at its headquarters, Dean House, 2, Dean Street, London, W.1.

**Radio Traffic** handled by the I.M.R.C. operators during the first round voyage of the *Queen Elizabeth* to New York and back to Southampton totalled 131,600 words, excluding the "copy" for the daily newspaper *Ocean Times*. In addition, 607 radio-telephone calls were handled to and from subscribers in four continents and 32 separate broadcasts were transmitted to various broadcasting systems.

**"Science To-day"** is the title of a weekly news-letter, the first number of which appeared on October 10th. Published by Weekly Science Newsletter, Ltd., 104, Clifton Hill, London, N.W.8, this eight-paged pocket-sized booklet is intended for the general reader and, in

addition to some original matter, will contain in tabloid form material that has appeared in technical journals.

**Radio S.E.A.C.**, Ceylon, is to act as a relay station for the transmissions of the B.B.C. Test Match commentaries from Australia, which are to be given from November 29th.

**Belgium.**—Instead of continuing the pre-war practice of having two amateur societies in Belgium—one French-speaking and the other Flemish-speaking—it has been decided to have one only, which will be known by the initials U.B.A. (Unie van de Belgische Amateurzenders), the address of which is P.O. Box 634, Brussels. A temporary licence is available for pre-war ON transmitters who produce evidence of loyalty during the German occupation.

**Radio Teleprinter Link.**—The opening of a new radio teleprinter circuit between the R.A.F. and the Royal Canadian Air Force is one of the first steps in a plan to bring all the Air Forces of the Dominions into direct teleprinter communication. A similar Pacific link is to be established between Vancouver and Australia. The new circuit links London, Ottawa, Vancouver and Halifax.

## INDUSTRIAL NEWS

**Imports.**—Arrangements whereby Token Imports into this country at the rate of 20 per cent of the pre-war trade are permitted from Canada, the U.S.A., Belgium and Switzerland have been extended to include France, Denmark, Holland and Sweden. With the exception of H.T. batteries, radio apparatus is not in the list.

**Philco.**—The Philco service scheme, originally known as Radio Manufacturer's Service, is to be



discontinued, the servicing of receivers being undertaken by accredited dealers. The company is planning to start a television school to which each dealer will be expected to send a serviceman to take the prescribed course.

**Rubber Bonders, Ltd.**, recently showed some of the applications to radio of their process of bonding rubber to metal. The process is used not only in the manufacture of apparatus, but also for making shock-proof mountings to protect delicate equipment in packing cases. A similar exhibition is to be held from December 16th-20th at the Chorlton Town Hall, All Saints, Manchester. Admittance will be by business card or ticket obtainable from Flexilant Works, Dunstable, Beds.

Ekco reports a growing waiting list of "pupils" for the week's course at the company's television school for servicemen at Somerton Works, Southend-on-Sea.

**I.M.R.C.**—Dedicated to the Company's 110 Radio Officers "who sacrificed their lives in the Battle for Freedom," the 44-page "War Story" of the International Marine Radio Company gives a graphic description of its work in equipping and manning the country's merchant ships.

Marconi long- and short-wave telegraph transmitters have been ordered by the Swedish Telegraph Administration for installation at Karlsborg, southern Sweden, and Grimeton, on the Swedish west coast, respectively.

Marconi communication and D.F. equipment is installed in the 15,000-ton whaling ship *Balaena*. She carries medium- and short-wave transmitters and receivers as well as radiotelephone equipment, whereby she can keep in touch with her fleet of catchers and the three aircraft which she carries. A Marconi automatic beacon transmitter which she carries will enable the



**TELEVISION O.B. FLEET.**—Three of the four vehicles in the B.B.C. television outside-broadcast unit are shown in the top picture. They are, left to right, the scanner van, transmitting van and aerial vehicle. An interior view of the vision transmitting van is inset. A fourth van is equipped to provide power in the absence of a mains supply. When transmissions are made from places near the route of the co-axial cable, installed around selected areas in central London, the output from the scanner van is fed into it either directly or via the ordinary telephone circuits, provided the length of this is not more than three miles, as was the case for the Cenotaph broadcast on November 10th, when the photograph on the left was taken. When transmissions are made from points outside the circuit of the co-axial cable they are radiated from the eighty-foot fire-escape aerial, picked up at a receiving station in Highgate, and fed to Alexandra Palace.

### World of Wireless—

catchers to "home" on her with their own D.F. equipment.

**B.I. Callender's Cables, Ltd.**, are purchasing a 23-acre site on the Kirby Trading Estate, Liverpool, for a new factory which initially will have a floor area of some 250,000 square feet. The Worcester office of B.I. Callender's Cables is now at 37, Broad Street. The telephone number is unchanged: Worcester 2070. The Manchester office is now at Faraday House, Todd Street, Manchester, 3. Tel.: Blackfriars 7044/5.

**Antiferne, Ltd.**, has now opened offices at 67, Bryanston Street, London, W.1 (Tel.: PAD 7253), which will house the Sales and Accounts Departments.

**Scottish Plastics, Ltd.**, has transferred its manufacture of plastic mouldings to Avenue Works, Walthamstow, London, E.4.

**Britannia Batteries, Ltd.**, has moved into new offices at Trafalgar House, 9, Great Newport Street, London, W.C.2 (Tel.: TEM 2354/5).

**Pye, Glasgow.**—The Glasgow office of Pye, Ltd., is now at 21, Waterloo Street. Tel.: Glasgow Central 8301.



**"CINTEL" METAL DETECTOR**, an adaptation of the wartime mine detector produced by Cinema - Television Ltd. Working under average conditions, it is claimed to locate accurately to within an inch or two, 6in pipes, etc., buried up to 2ft 9in below the surface.

### CLUBS

**Bradford.**—Sir Edward Appleton, a Bradfordian, is the first president of the Bradford Amateur Radio Society. Weekly meetings are held on Mondays

at its headquarters, Cambridge House. Secretary: J. H. Macdonald, G4GJ, "Mayfield," Waggon Lane, Bingley, Yorks.

**Bromley.**—Officers of the North-West Kent Amateur Radio Society were elected at the inaugural meeting on October 25th at the Aylesbury Road School, Bromley, where regular meetings will be held on the last Friday in the month. Secretary: L. Gregory, G2AVI, 18, Upper Park Road, Bromley, Kent.

**Dumfries.**—The recently formed Dumfries and Galloway Amateur Radio Society meets on alternate Tuesdays in the Cairndale Hotel, Dumfries. The Secretary is D. F. Halliday, GM2AHD.

**Grimsby.**—With a membership of 18 the town's short-wave society recently resumed activities under the new name of Grimsby Amateur Radio Society. Meetings are held each Thursday at 7.30 in the Oddfellows' Hall, Victoria Street. Secretary: S. Stocks, G8KH, 60, Tunnard Street, Grimsby, Lincs.

**Ilford.**—Members of the Ilford and District Radio Society recently had the opportunity of hearing a demonstration of F.M. given by Messrs. Mould and Falconer, of G.E.C. The 26-valve demonstration set was one of a number being produced for B.B.C. test purposes and incorporated both F.M. and A.M. channels with a common A.F. amplifier. A motor cycle engine caused no detectable interference on F.M., although on A.M. interference was well up to signal level. Tests were conducted on the Alexandra Palace F.M. transmissions on 90.4 Mc/s. Secretary: C. E. Lagen, 44, Trelawney Road, Barkingside, Essex.

**Islington.**—Meetings of the recently re-formed Islington Radio Club are held on Wednesdays and Fridays at 7.15 at the Robert Blair School, Brewery Road, Caledonian Road, Islington, N.7. Secretary: G. E. Lazell, 49, Hungerford Road, London, N.7.

**I.S.W.C.**—The London Chapter of the International Short-Wave Club is now meeting each Friday at 8.0 at the Buckingham Gate School, Palace Street, S.W.1. Details, and a specimen copy of the I.S.W.C. News Letter, are obtainable from A. E. Bear, 100, Adams Gardens Estate, London, S.E.16.

**Leicester.**—The next meeting of the Leicester Radio Society will be held on December 10th at the Charles Street United Baptist Church at 7.30, when R. G. Hibberd, B.Sc., will lecture on wide-band amplifiers. A television section has been formed and meets on alternate Tuesdays to the Society. Secretary: O. D. Knight, 16, Berners Street, Leicester.

**North-East.**—Meetings of the North-East Amateur Transmitting Society are held alternately in South Shields, North Shields and Sunderland. Details are obtainable from the Secretary, 45, Empress Street, South Shields.

**St. Helens.**—Meetings of the new St. Helens and District Radio Society are to be held each Tuesday at 8.0 at 100, Kirkland Street, St. Helens. Secretary: J. K. Birch, G2FOS, 19, Knowsley Road, Rainhill, St. Helens, Lancs.

**Warrington.**—Fortnightly meetings of the recently formed Warrington and District Radio Society are held at the Pelican Hotel, Buttermarket Street, Warrington. Secretary: S. Allen, G8TR, 25, Bruche Drive, Padgate, Lancs.

**West Cornwall.**—Monthly meetings of the West Cornwall Radio Club are held in both Penzance and Falmouth on the first and third Thursdays, respectively. Secretary: R. V. A. Allbright, G2JL, "Greenacre," Lidden, Penzance.

### MEETINGS

#### Institution of Electrical Engineers

**Radio Section.**—"The Elements of Wave Propagation Using the Impedance Concept," by Dr. H. G. Booker, on December 4th.

Discussion on "The Design and Performance of Receiving Aerials for Television," opened by E. C. Cork, B.Sc., on December 10th.

Both meetings will be held at 5.30 at Savoy Place, London, W.C.2.

**Cambridge Radio Group.**—"Recent Advances in Electronics Applied to Medicine," by G. Parr, on December 17th at 6.0 at the Cambridgeshire Technical College.

**Scottish Centre.**—"Naval Fire-Control Radar," by J. F. Coales, M.A., H. C. Calpine, B.A., and D. S. Watson, B.Sc., on December 18th at 6.0 at the Heriot-Watt College, Edinburgh.

**South Midland Centre.**—"Colonial Telecommunication Systems," by C. Lawton and V. H. Winson, B.Sc. (Eng.), on January 6th at 6.0 at the James Watt Memorial Institute, Great Charles Street, Birmingham.

#### British Institution of Radio Engineers

**London Section.**—"Quartz Oscillators," by Dr. P. Vigoureux, on December 19th at 6.0 at the London School of Hygiene and Tropical Medicine, Keppel Street, London, W.C.1.

**N. Western Section.**—"The Strobe Principal in Radio and Radar," by L. H. Bedford, O.B.E., M.A., on December 4th at 6.30 at the College of Technology, Manchester, 1.

**N. Eastern Section.**—"A Review of Radio Aids in Aviation," by C. B. Bovill, on December 11th at 6.0 at Neville Hall, Westgate Road, Newcastle-on-Tyne.

**Scottish Section.**—"Aircraft Radio," by C. B. Bovill, on December 12th at 6.45 at the Institution of Engineers and Shipbuilders, Elmbank Crescent, Glasgow, C.2.

**Midlands Section.**—"A.C. Behaviour of the Barrier-Layer Photo Cell," by J. A. Sargrove, on December 12th at 6.45 at the Coventry Technical College.

#### Institute of Physics

"The X-ray Examination of Radio Valves," by E. G. W. Bowers, on December 6th at 6.30 at the Royal Society, Burlington House, London, W.1.

#### Radio Society of Great Britain

"The Dependence of Ultra-Short-Wave Radio Propagation on Weather," by Dr. H. G. Booker, on December 20th at 6.0 at the I.E.E., Savoy Place, London, W.C.2.

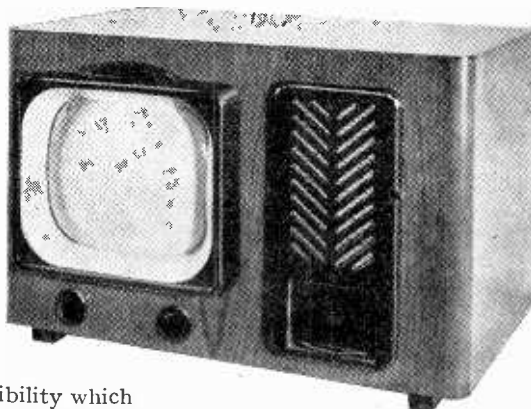

**TEST REPORT****PYE TELEVISION MODEL B16T***Receiver for Vision and Sound Only***Picture Size - - 7½ in × 6 in****Valves - - - - 15 + 2 Rectifiers****Panel Controls - Sound Volume, Picture Brilliance****Price - - - - £35 + £7 17s. 3d. Purchase Tax**

It has been commonly said that post-war television would gain much from war-time experience on radar and many have looked forward to great improvements. Some who are familiar with both techniques and who appreciate their differences as well as their similarities, have doubted the truth of this general belief. A trial of a model of one of the first post-war television receivers is thus a matter of especial interest.

The performance of this set undoubtedly settles the matter for it is very considerably superior to comparable pre-war models.

War-time experience are to be noticed chiefly in the compact layout, improved workmanship, and the remarkably high degree of accessibility which has been achieved.

The set provides television sound and vision with only two panel controls — sound volume and picture brilliance. All other controls are pre-set and can be divided into two groups, of which one is of the genuine pre-set type and the other is termed by the makers "auxiliary controls." The true pre-set controls are mounted

behind a sliding panel under the speaker grille and are accessible from the front. They comprise the contrast, focus, line-hold and frame-hold controls.

The pre-set controls at the rear are:—line linearity, line amplitude (= picture width), frame linearity, frame amplitude (= picture height), frame sync, vision sensitivity and sound sensitivity. Overall width of the cabinet is 21½ in and height is 14½ in. The overall back-to-front dimension is 16½ in, measured over the projecting guards for both the base and screen of the 9-in C.R. tube, which gives a picture 7½ in by 6 in.

The circuit diagram shows that the vision receiver is a straight set, comprising four R.F. stages, diode detector, and one V.F. stage. The first two R.F. stages are common to sound and vision—the channels are then split with two further R.F. stages for vision only and two more for sound only. A diode detector, diode noise-suppressor and a pentode output valve complete the sound side.

The separation of the sound and vision signals is effected in the cathode circuit of the third R.F. stage. A circuit tuned to the sound channel is included here and serves the double purpose of picking out the sound signal and of rejecting it from the vision channel. A similar circuit is included purely as a rejector in the cathode lead of the fourth stage.

Variable control- and suppressor-bias is applied to the

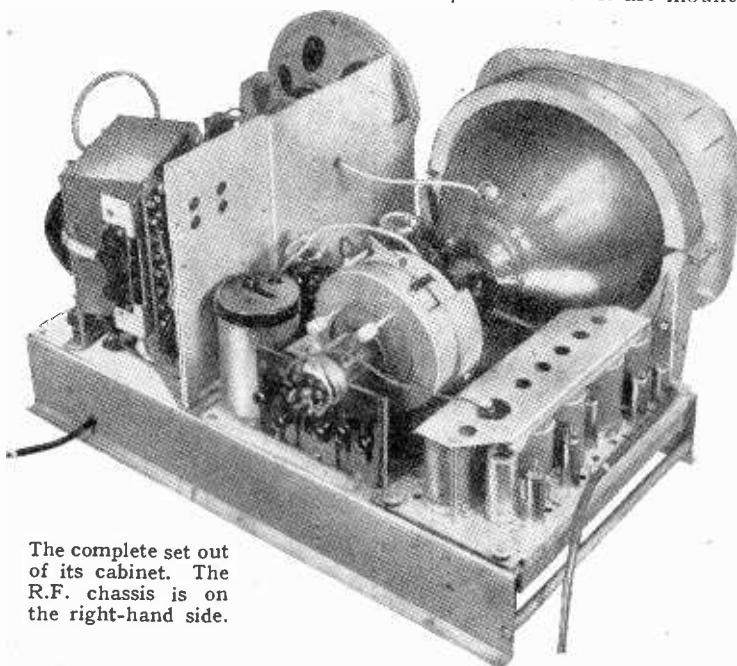

The complete set out of its cabinet. The R.F. chassis is on the right-hand side.

The picture is brighter and clearer, the synchronizing more reliable, and the overall cabinet size considerably smaller. The benefits of

at the rear of the chassis and are accessible only when the back of the cabinet is removed. The auxiliary controls are mounted

**Pye Television Model B16T—**

first three stages and to the first stage of the sound channel by three separate controls. Bias is applied to both grids in a fixed ratio to prevent its affecting appreciably the input capacitance and resistance of the valves and so altering the tuning and damping of the circuits. The bias control of the first stage is the vision sensitivity control and is pre-set for the required gain according to the location of the receiver. Similarly, the bias control of the first stage in the sound channel is the sound sensitivity control and is also pre-set. Bias on the second and third R.F. stages is an auxiliary control—picture contrast.

The detector is conventional, but there are two unusual features

in the V.F. stage. The first is the use of a small capacitance shunting the cathode-bias resistance, instead of an inductance in the anode circuit, to give high-frequency compensation, and the second is the use of negative feedback in conjunction with a diode. A 10-M $\Omega$  resistor and a 0.1- $\mu$ F capacitor are connected in series between grid and anode, and the resistor is shunted by a diode.

Since the V.F. stage feeds the tube cathode directly the picture signal is negative-going, and the sync pulses positive-going, on its anode. When current flows one way in the resistor the diode is non-conductive and the feedback is very small. When it flows the other way, the diode becomes conductive and feedback is rela-

tively large. The mean charge on the capacitor keeps the voltage across it at about the level of peak white, so that the diode is non-conductive over most of the picture signal, but conducts to suppress ignition interference on signal peaks above white level.

On the sound side, the noise suppressor is interesting. The detector itself is conventional but the load resistance and capacitance are given unusually small values in order to preserve the peakiness of ignition interference voltages. The output is applied through a diode with a positive bias applied to its anode, so that it is normally conductive. Being taken from the cathode of the detector diode, the signal and interference are positive-going for increasing amplitudes and they

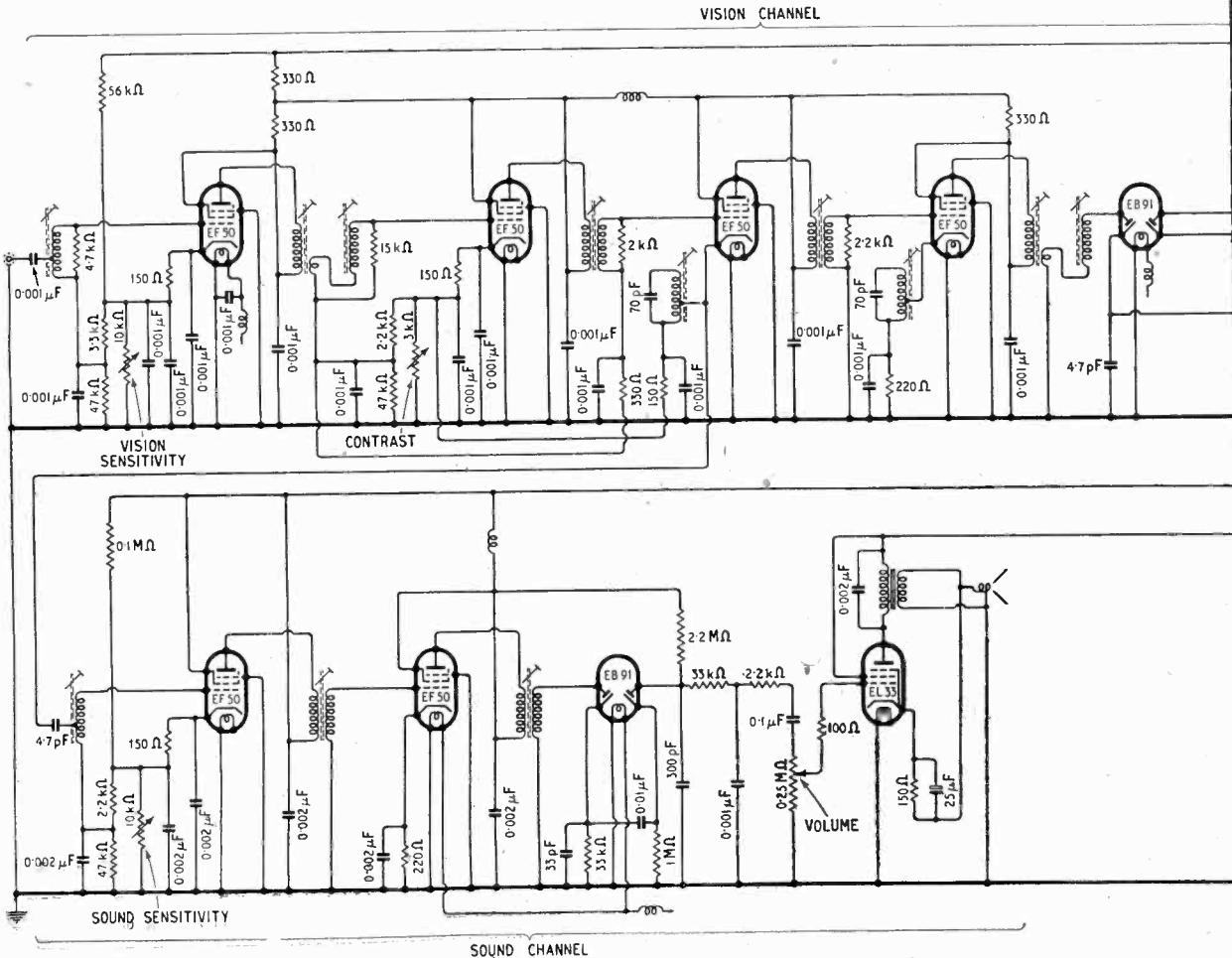

The circuit diagram shows the whole equipment. The vision channel has 4 R.F. stages, the sound signal being picked up after the second and fed to the sound channel with 2 further R.F. stages.

are applied to the cathode of the suppressor diode. The adjustments are such that this diode remains conductive over the whole range of normal signal amplitudes, but becomes non-conductive on a noise peak which exceeds its bias voltage.

The sound volume control is the usual potentiometer on the input to the output valve. Negative voltage feedback is applied to this stage by including the speech coil of the loudspeaker in the pentode cathode circuit. Two stages of resistance-capacitance smoothing are used for the H.T. supply to this valve.

Turning now to the sync separation and time-bases, the V.F. signal is applied to the sync separator with a D.C.-restoration circuit in its grid. The valve

eliminates the picture signals by anode current cut-off and a series grid resistance also gives noise limitation on the tips of the sync pulses.

The separated pulses are negative-going at the anode and are applied directly through a small capacitance to the anode of the line-scan blocking oscillator. This anode is really the screen grid, for a pentode is used with the control grid and screen functioning as the grid and anode of a conventional blocking oscillator and the anode proper acting as the discharge electrode for the time-base capacitance.

The saw-tooth voltage developed here is applied to the output pentode, which has variable cathode feedback as the line amplitude control. Transformer

coupling to the deflector coil is used and the line linearity control is a variable resistance in series with a capacitance across the transformer secondary.

"Line hold" is a grid bias adjustment on the blocking oscillator.

On the frame side, a double diode is used to separate the frame pulses and the circuit is somewhat unusual. Between pulses  $D_1$  is conductive and  $D_2$  non-conductive because as the EF50 sync separator is not drawing current, the anode of  $D_1$  is returned to a point more positive than the anode of  $D_2$  and C becomes charged to bring the cathode potential of  $D_1$  and  $D_2$  very nearly equal to the anode potential of  $D_1$ . The time constant CR is made of the same order of magnitude as the duration of a single frame pulse.

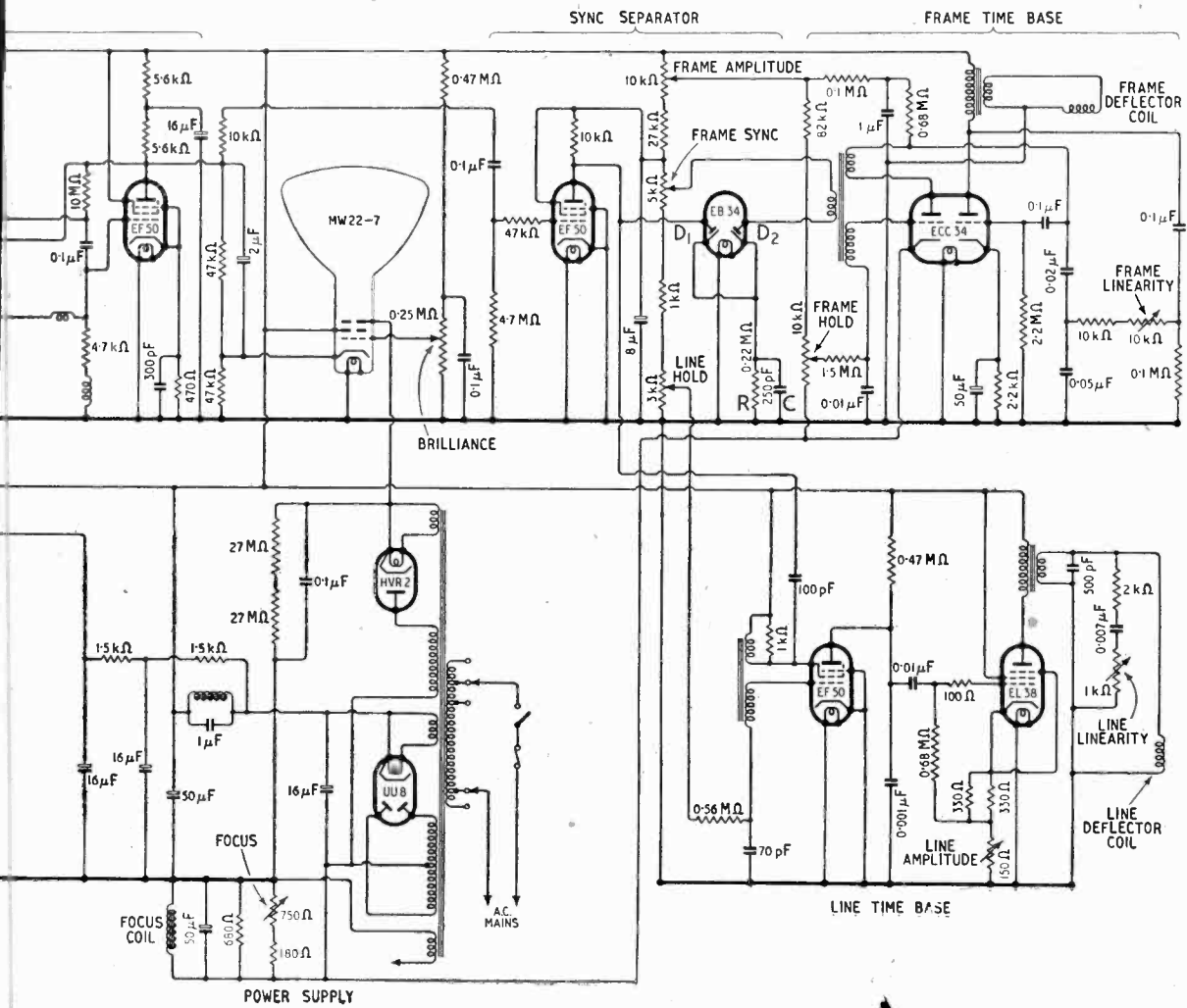

**Pye Television Model B16T—**

On a line pulse the anode voltage of  $D_1$  drops sharply, but because of CR the cathode voltage can drop only relatively slowly. Therefore,  $D_1$  becomes non-conductive. During the short line pulse the cathode voltage does not fall sufficiently for  $D_2$  to become conductive. Line pulses thus produce no output.

On a frame pulse the same thing happens and  $D_1$  becomes non-conductive. As the pulse is longer, however, C can now discharge sufficiently for  $D_2$  to become conductive with the result that current flows in it and through the winding coupled to the frame blocking oscillator, so tripping this valve.

The whole frame time-base is a double triode of which one-half acts as a blocking oscillator and the other as the output valve feeding the deflector coil through a transformer. Linearization is obtained by a form of negative feedback and the frame linearity control adjusts the magnitude of this.

The focus coil is connected in the negative H.T. supply lead with a shunt variable resistance as the focus control. The focus

coil does not correspond with that of the coil the adjustment screws are placed offset from the vertical and horizontal axes of the tube.

A single rectifier provides all H.T. but the high voltage, and a single tuned choke is used for smoothing, together with very large capacitances. The E.H.T. supply is provided by a half-wave rectifier. A single transformer carries all windings for L.T., H.T., and E.H.T. supplies.

The set is designed for use with a coaxial aerial feeder and an aerial assembly—although not considered a part of the set—is available. It consists of a tubular dipole with reflector supported by metal arms in the centre. The four arms are insulated at the centre and connected to a matching device contained in a polythene moulding. This comprises a matching transformer for the cable-to-aerial connection and a loading inductance for the reflector.

A 20-ft galvanized tubular mast is provided—the cable being run up its centre—and there are clamps for attaching it to a chimney stack. The aerial equipment is very easy to assemble and has a high front-to-back ratio.

This, together with the well-balanced matching of the aerial and feeder, reduces interference to a minimum.

On test the equipment proved excellent. The aerial was erected on the roof of a building containing a good deal of electrical machinery which was known to cause considerable interference with an un-screened two-wire transmission line for the feeder. No trace of such interference was found with the Pye aerial.

An underview of the chassis showing the accessibility of components.

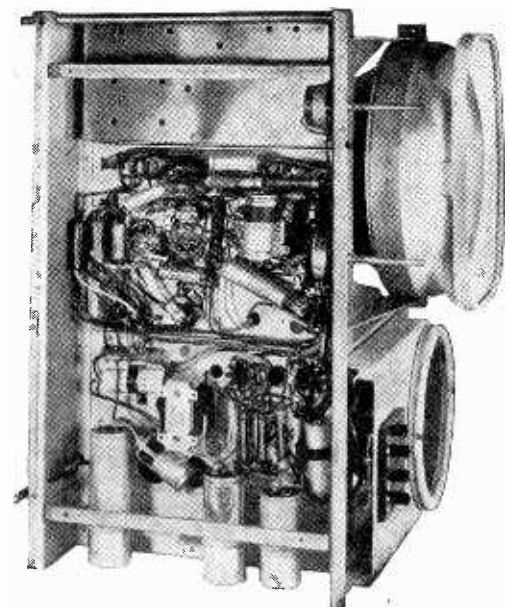

coil itself can be tilted for picture centring, and there are two screw adjustments for vertical and horizontal movement of the picture.

The set itself proved most reliable. It could be switched on and always gave a good picture without touching the auxiliary

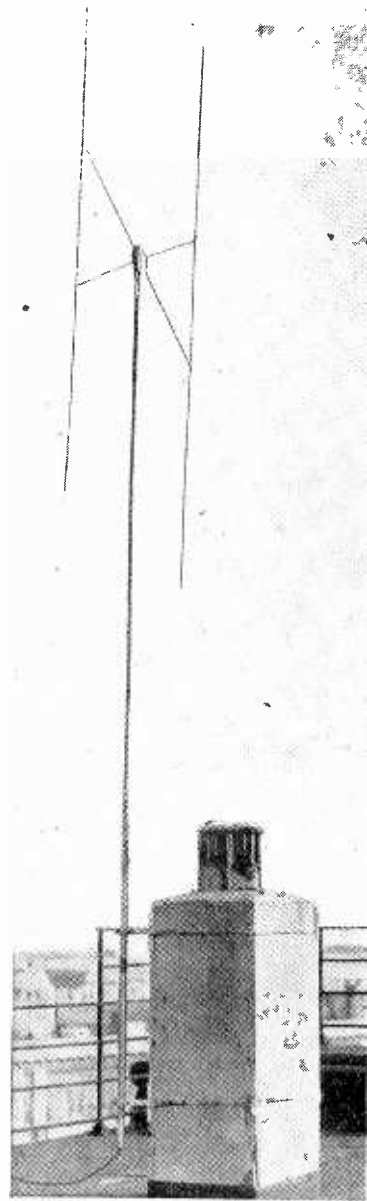

The aerial is shown here erected on a chimney stack.

controls. Although these controls were often adjusted to see whether any improvement could be effected, after the initial adjustment on first connecting up the set, one always came back to the same settings. In normal operation one can forget all about the controls and it is necessary only to switch on and, after the initial warming up period of about one minute, to turn up the brilliance

control to the required level.

There is a slight drift of focus with time, but it is very small. There is a tendency to pull on whites on the test pattern; again this is small, and was never observed on any picture but the test pattern. The resolution is adequate for the 2-Mc/s test bars and one can distinguish that there are 2.5-Mc/s bars.

The synchronizing is extremely good and the picture is rock steady. Interlacing is not perfect, there being a certain amount of weaving, but it is far better than the usual pre-war standard.

The picture brilliance is considerable and quite adequate for daylight viewing, while the contrast in both blacks and whites is excellent. The linearity of the scans is adequate, for even on the test pattern it is hard to detect any non-linearity. This is remarkable in view of the simple nature of the scan circuits. The focus is not quite even over the whole picture, for it goes out a little in the corners, but again it is much better than in the pre-war days.

The performance of the set does great credit to its designers but the merits of the set do not stop short at its performance. It is quite rare that one can praise a set both for its electrical design and performance and also for its mechanical design, but this is a case in which the mechanics have obviously been given careful thought.

Two captive screws hold the

back in place. Three bolts along the back of the chassis hold it to the cabinet and the bolts are accessible from the top. The two panel knobs are spring loaded and pull off. The whole chassis including tube and speaker can then be pulled out without disconnecting any leads. It is held at the front by a projecting lip on the chassis which passes under a retaining strip on the cabinet, so that there are no awkward screws.

All components are accessible and it is to be noted that only the smallest capacitors are held by their leads; the larger types are held by clips. In spite of the small size of the whole set, the accessibility for servicing is far and away better than in many, perhaps the majority of, ordinary broadcast sets.

The set is priced at £35 plus £7 17s. 3d. purchase tax. The aerial equipment costs £3 17s. 6d.

## OUR COVER : New Brookmans Park Mast

A NEW parallel-sided lattice-steel mast radiator 500 feet high was recently brought into use by the B.B.C. at the Brookmans Park station. It was erected to improve the reception of the London "Home Service" on 342.1 metres in parts of Kent, Surrey and Sussex.

British Insulated Callender's Cables designed and erected the mast which is supported on three hollow cylindrical porcelain insulators, each one foot high. A low-capacity insulator is also provided at 400 feet, dividing the mast into two sections.

An adjustable capacity loading unit is fitted. It consists of a number of tubular steel radial booms, thirty feet long, which are jointed at their extremities and carry peripheral wires. The radiator can also be adjusted to secure the greatest possible non-fading range by varying the inductor carried on the platform at the top of the lower

section. This, together with the three oil-filled cylindrical porcelain insulators at the 400ft level, can be seen in the illustration on our front cover. Each of these insulators is 3ft high and 6in in diameter.

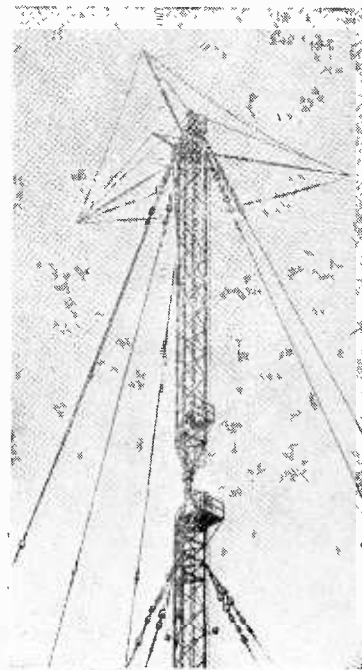

The upper section of the new mast surmounted by the capacity loading ring is shown on the right.

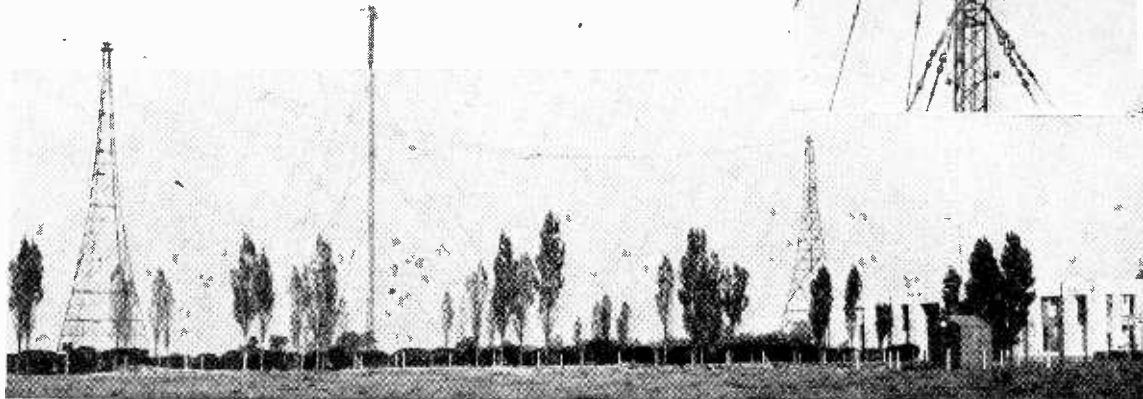

The new 500-ft mast and one of the old aerials at Brookmans Park The station building is on the right.

# RADIO v. U-BOAT

## An Account of the Part Played by Radio in the Battle of the Atlantic

By G. M. BENNETT

THE story of the Battle of the Atlantic, of which the official account has just been published, would be incomplete without an account of the vital part played by radio, both in ships and aircraft, for it was largely fought behind the scenes between Allied and Axis technicians. Each was constantly striving to be one jump ahead of the other in producing equipment which more effectively met operational requirements whilst avoiding detection and thereby the production of counter-measures by the enemy.

High-frequency direction-finding which played such an important part had been developed as early as 1930 but the results achieved were poor compared with those of M.F. and unless the D.F. aerial was fitted at the truck of the highest mast, the results were generally of negligible value. A fair proportion of capital ships, cruisers and destroyers, were fitted with an early form of high-frequency D.F. before the war but in 1939 the equipment was rapidly being removed in order to free the masthead positions for the aerials of the newly developed radar warning sets.

In 1940, however, it was appreciated that high-frequency W/T transmissions from U-boats in the Atlantic were an indispensable part of their operations, particularly for developing pack tactics. Whilst these transmissions could be located by the naval shore D.F. stations and the approximate position of a U-Boat thereby fixed, the information was not of sufficient accuracy to enable convoy escorts to take offensive action against the submarine. The urgent need for H.F. direction-finding in the escorting vessels thus became apparent and at the beginning of 1941 two destroyers were fitted

for trial with a newly developed set, covering 1 to 20 Mc/s. It incorporated for the first time sense-finding facilities (Fig. 1).

The aerial for this set was fitted on the foremast at the expense of a radar warning set. The fleet was very reluctant to accept this sacrifice. Consequently effort was concentrated on finding ways of reducing the errors to which these sets were subject when their aerials were fitted in inferior sites. It was found that useful results were obtainable in destroyers with the

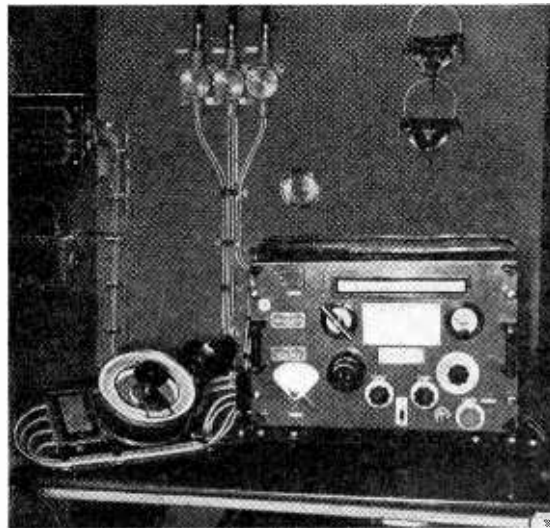

convoys to take more effective action. It was not long, however, before its more important offensive capabilities were shown. Unfortunately, with the direction-finders then in use it was very difficult for even skilled operators to distinguish between ground-wave interceptions from U-boats probably endangering the convoy, and sky waves from U-boats which might be hundreds of miles away. The technique for doing so was gradually developed, and, as the number of D.F. equipped ships with each convoy increased, it became possible to supplement the operator's estimations of range by plotting simultaneous cross bearings from several ships.

In 1941-42, a new H.F. direction-finder was developed employing cathode-ray tube presentation of intercepted signals (Fig. 3). This enabled operators to distinguish with greater certainty between sky-wave and ground-wave and thereby to determine whether a U-boat was within about 50 miles. It also enabled

Fig. 1. Naval high-frequency D.F. receiver employing fixed crossed loops and goniometer with sense-finding facilities.

aerial sited aft on a short pole mast, provided its distance from the foremast or funnel or any other vertical structure was sufficiently great (Fig. 2). Three destroyers were fitted in this way in the latter half of 1941 and a programme for fitting many more vessels employed on convoy escort duties was initiated.

Initially the principal value of high-frequency D.F. in ships was to supplement fixes obtained by shore stations by giving greater accuracy and thereby enabling

accurate bearings to be taken of the comparatively short transmissions which U-boats were then radiating in an effort to avoid being located. A more accurate estimation of range became practicable as a result of an examination of the W/T equipment of a U-boat (renamed H.M.S. *Graph*) captured in 1941 and extensive trials with it to ascertain the normal field strength obtained at different ranges. The new set proved much superior to its predecessor.

It was first fitted in a sloop at the end of 1941 and soon afterwards became the Navy's standard high-frequency D.F. set.

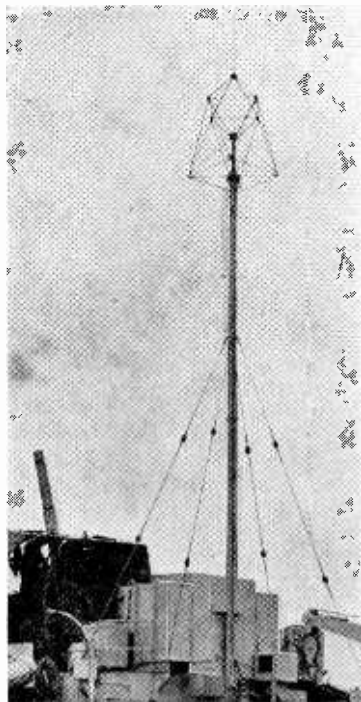

Fig. 2. Aerial for H.F. direction-finder (fixed crossed loop) mounted on stump mast at after end of destroyer.

Throughout the war our convoys and their escorts kept wireless silence as far as possible, though conditions sometimes arose when the use of R/T by escorts was essential if they were to co-operate with each other and with aircraft in searching for U-boats closing the convoy and driving off those which attacked. For this a frequency of the order of 2,500 kc/s was normally used and the risk of interception and D.F. by the Germans had to be accepted. In fact the German shore D.F. stations seldom, if ever, did intercept such transmissions, and few U-boats were fitted with equipment by which they might have intercepted our escorts' transmissions and homed on to our convoys.

Towards the end of the war an attachment called "Presskohle" enabling a standard U-boat receiver to be used for taking bearings in the band from 1,500 to

3,000 kc/s was produced. Later the idea was conceived of a set using crossed D.F. loops fixed to the top of the Schnorkel tube, a combined breathing tube and exhaust for the diesel motors enabling the U-boat to operate practically continuously submerged—a necessity owing to the increased use of radar by ships and aircraft. This was not ready for sea trial when the war ended and the "Presskohle" had been fitted in only a small number of U-boats.

At the beginning of the war the Navy gave priority to the development of long-range radar equipment to give warning of the approach of enemy aircraft. No equipment had been developed for the detection of surface craft, including submarines on the surface. R.A.F. Coastal Command had, however, developed A.S.V. radar operating in the  $1\frac{1}{2}$ -metre band, which came into operational use as a means of detecting surfaced U-boats from the air early in 1941.

Meanwhile, an officer of the Fleet Air Arm, working on the adaptation of this R.A.F. equipment for Naval Air Arm work was testing a set in a Walrus aircraft on a slipway at Lee-on-Solent when he noticed that it could detect shipping in the Solent at a useful range. Proposals followed to adapt this set, of which large numbers were already in production, for use in destroyers and other types of warship employed escorting convoys. A fixed aerial resembling a cross between a giant box kite and a wire mattress was produced and fitted at the masthead (Fig. 4). With this equipment the display took the form of horizontal echo deflections on either side

Fig. 3. C.R.T. presentation of intercepted signals is provided in this high-frequency D.F. set.

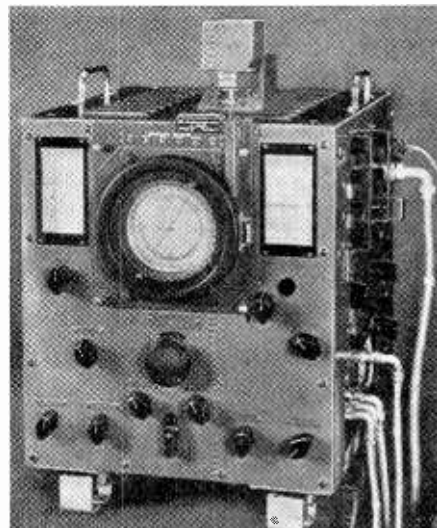

of a vertical trace. When equal echo deflections appeared on either side of the trace, the target was dead ahead. The equipment was, therefore, limited to the extent that it was only pos-

sible to detect objects within an arc of approximately 40 degrees on each bow and to obtain an accurate bearing it was necessary to alter the course of the ship. Such limitations, which were of no importance in aircraft, were so serious for ships that the fixed aerial was soon replaced by a rotating one. Subsequently, in 1942, a more powerful transmitter of naval design, incorporating a rotating aerial, replaced the adapted aircraft type and the equipment then fulfilled the dual functions of detecting both surface vessels and aircraft.

Meanwhile the Germans had appreciated that their U-boats were being located and attacked too often for this to be due to visual sightings alone. They were alive to the possibilities of metre-wave radar and early in 1942 they captured a complete A.S.V. set. They accordingly concluded that this was causing the trouble and tests in the summer of 1942 confirmed that the transmissions were easily detectable by a simple receiver and aerial. Doenitz ordered the speediest equipping of all boats with a make-shift equipment. The result was the "Metox," a tunable search receiver. Technically it had many

shortcomings though it was undoubtedly capable of fulfilling the functions for which it was designed. In particular, A.S.V.-fitted aircraft could be detected at ranges which enabled U-boats to

**Radio v. U-boat—**

dive before they approached. Of its principal technical defect—radiation—more will be said later.

All this time the research effort of the Allies had been concentrated on the development of higher powered radar operating on shorter wavelengths. Both were made possible by the development of the strapped magnetron for the transmitter and of a new type of velocity-modulated valve to provide the local oscillator frequency required for a receiver operating on such a high frequency. The production of new surface detection radar ships and A.S.V. for aircraft followed (Fig. 5). Tremendous efforts were made both by the manufacturers to produce the sets and by the shipyards and R.A.F. technicians to fit the maximum number of ships

one and a half to four miles. As a result the extent to which the German Metox receiver provided immunity from detection by the Allies was almost at once nullified. U-boat sinkings which had temporarily dropped were once again on the up-grade.

By the early part of 1943 the Germans were again very worried. In seeking a reason for the renewed Allied success in detecting U-boats, they discounted the possibility of it being due to radar operating on shorter wavelengths since, without the strapped magnetron, they themselves had been unable to produce radar operating on such frequencies. The first possible explanation which occurred to them was that we were employing supersonic modulation on our metre-band A.S.V. which resulted in a signal inaudible in the

headphones of the Metox. They accordingly fitted a visual tuning indicator of the "magic eye" type. Fortunately, some naval aircraft operating at this time were employing supersonic modulation and this was sufficient to suggest to the Germans, temporarily at least, that they had solved the problem. But after a further couple of months of steadily mounting U-boat losses it became pain-

in fact erroneous, suggested that the Allies had either developed infra-red detection apparatus or alternatively an anti-interception technique for A.S.V. which involved it being only switched on for such short periods as to render it undetectable.

Hardly had the Germans started to pursue these two ideas when they dropped them in favour of a real will-o'-the-wisp. They decided that all their troubles were due to the fact that we were detecting the already mentioned strong radiations from the Metox receivers. They were at once withdrawn from service and a new search receiver, the Wanz GI, developed at high speed, was fitted in lieu. The radiation from this was relatively small but under pressure of continued sinkings of U-boats a mental stampede began, the new set was withdrawn from service almost as soon as it had been fitted and in August, 1943, they went to the extent of producing a replacement, the Borkum, which remarkably enough employed a crystal detector. They accepted its inefficiency in favour of its complete inability to radiate.

It is of interest to record that it was at about this time (early 1944) that the German U-boat Command took the step of sending to sea a U-boat fully equipped to investigate every type of Allied radio and carrying one of their best technicians with operational experience. Unfortunately (for the Germans) this U-boat was sunk after thirteen days at sea. Another vessel was at once similarly equipped but had an even shorter career.

It was not to be expected that the Allies' use of 10-centimetre radar would indefinitely remain secret. They first became aware of it in the latter half of 1943 by the capture of the R.A.F. blind bombing aid H2S. But though they appreciated that we might be using such frequencies against U-boats their efforts to produce a search receiver covering this waveband for fitting in U-boats were at first singularly unsuccessful. They turned to the production of radar decoys of which the most notable were a radar decoy balloon and a radar decoy spar buoy. Both of these could be dis-

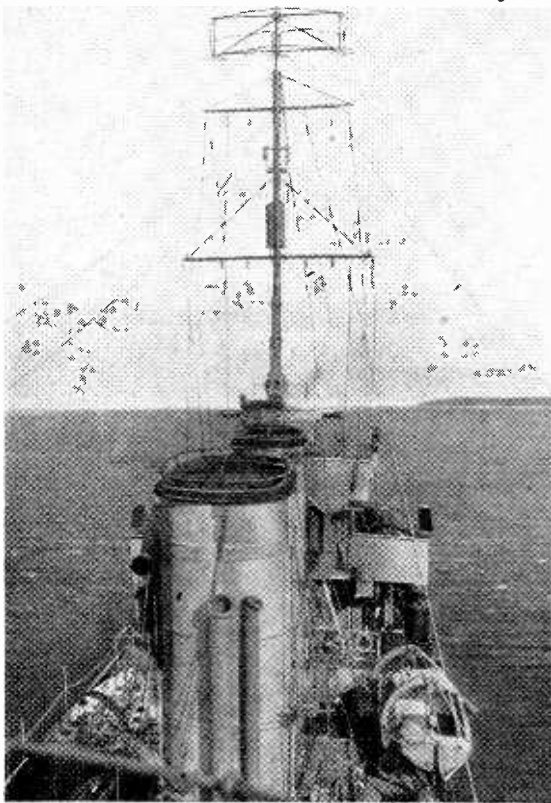

Fig. 4. The "mattress" aerial as used with the earliest type of radar equipment fitted in destroyers for the detection of U-boats.

and planes with this new equipment since it gave markedly superior results over the previous longer-wave type. To cite but one example, the range at which a surfaced U-boat could be detected by ships was increased from about

fully apparent to them that the "magic eye" was, in fact, no solution and a search for an alternative began. They then explored two further blind alleys. Reports of observations from operational U-boats, which were



charged from submarines and gave to our radar sets an effective echo. It was hoped that our ships would pursue the decoys, thereby giving time for a U-boat to submerge and

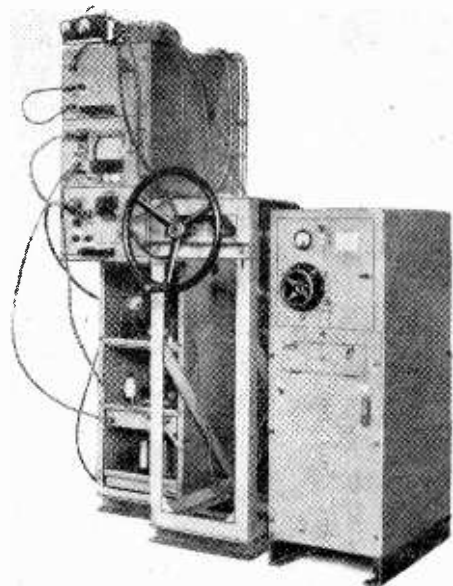

ture of a new version of H2S and turned to the development of a search receiver for use against it. They failed, however, to produce the Naxos ZX (3 cm) or Naxos ZD (3 and 10 cm) before the end of the war. The Naxos ZM used a high-speed spinning aerial rotating at 1,300 revolutions a minute. The results were presented on a cathode-ray tube. By an ingenious device a spot of light was made to rotate round the edge of the tube in synchronism with the rotation of the aerial and the spot was then suppressed except when

Fig. 5. The first surface warning radar set of entirely Naval design for use in destroyers and other vessels operating against U-boats. It operates on a wavelength of 10 cm.

escape. Though these devices at first achieved some success it was not long before the ships' radar operators and plotting teams learnt to appreciate when a target was drifting with the wind or sea.

All this time Allied technicians had been far from inactive. Many improvements for the 10-centimetre radar sets had been developed notably stabilized aerials, which enabled the narrow beam radiated from the very directional aerial to remain horizontal despite the motion of a ship (Fig. 6), and P.P.I. methods of presentation. Of even greater importance, however, was the production of equipment operating in the 3-centimetre band. This was of particular importance in the case of aircraft owing to the reduction in size of both the equipment and the aerial. As a result, by the time the Germans were having any success at all with the 10-cm surface receiver ("Naxos ZM," which was only fitted in Coastal Forces craft), the Allies were already replacing equipment operating on that frequency with 3-cm apparatus. The Germans tumbled to our use of this frequency with the unavoidable cap-

a signal was being received. All signals received appeared as bright spots round the periphery of the tube, which was calibrated in degrees whence bearings could be read off.

In connection with search receivers the only item remaining to be mentioned is the German development of an aerial for fitting at the head of the Schnorkel tube in order to enable such sets to be operated while the U-boat was to all other intents submerged. The requirement for this arose as soon as they appreciated that, to the all-seeing eye of 3-centimetre radar, not even the small target presented by the head of the tube was wholly immune from detection by radar. Only the "Rundipole" aerial, operating in the metre-band, was produced whilst the "Athos" aerial working in the 3 cm band was under development.

There remains to mention briefly the extent to which the Germans fitted radar in their submarines. In this they were materially hampered by their inability to produce, for a long time, equipment operating in the centimetre band. The early German naval

radar was heavy, bulky and subject to frequent breakdown. Although fitted in a number of U-boats it was abandoned in the autumn of 1943 in favour of a modified version of the Luftwaffe A.S.V. set. Until the end of the war this remained standard U-boat equipment, using a small extensible "mattress" aerial which was housed in the side of the conning tower and rotatable from below.

This equipment was intended for the detection of our patrolling aircraft but its use was always limited because the U-boat captains, influenced by the extent to which they believed we were making use of the radiations from their search receivers, were extremely loath to transmit with it. Towards the end of the war the Germans, by making a "Chinese copy" of a captured British magnetron, succeeded in getting centrimetric radar going. But it is noteworthy that, whereas we had produced a radar set for our submarines effective for both the detection of aircraft and surface vessels, the Germans had been forced to design two, one for each purpose.

In conclusion, it may truthfully be said that radio played an essential part in the great majority of sinkings of Axis submarines dur-



Fig. 6. The stabilised aerial with parabolic reflector employed with a 10-cm surface warning radar set. The waveguide will be noticed.

ing the war. Our decisive victory in the radio war was, in fact, acknowledged by Grand Admiral Doenitz even before the end of hostilities.

## LETTERS TO THE EDITOR

### Ex-R.A.F. Sets + Status of "Technical Assistants"

#### R.A.F. R1155 Set

I READ with interest "Ex-Signals" outline of the R1155 receiver in your July issue and would like to add a few comments.

First, the VR102 twin triode (which is usually discarded along with the rest of the D/F gear) can be used as a class AB push-pull output stage giving moderate output with good quality. For the push-pull drive a small transformer may be mounted under the chassis. Should the amplifier type A1134 become available on the market then the ideal transformer for the job will be found therein. Assuming the above circuit is used, it is advisable to return the cathodes of the VR102 to H.T.—and not to chassis, otherwise at least one of the bias network resistors will object. Secondly, whether the set is modified or not, the main bias resistor (R40 in some sets) should be made a 2-watt resistor if not already so. It is the custom for a  $\frac{1}{2}$  or 1 watt to smoulder gently for reasons it knows best. This resistor is the 2-k $\Omega$  one, found under the magic eye, mounted on top of a block of paper condensers.

Lastly, I would mention that a friend of mine has succeeded in making an R1155 into a self-contained mains receiver (except for speaker) by mounting a mains transformer over the coil cans at the back, right-hand corner of the chassis, to supply 200-V H.T. and only one 6-V heater supply. The rectifier, mounted in place of one of the VA99A D/F valves, is a 6X5GT which operates happily with 250V between heater and cathode. Suitably chosen windings of the push-pull D/F oscillator transformer (found under the magic eye) are used for a smoothing choke. Electrolytics are mounted under the chassis and a 6V6 output stage is mounted in place of the VR102 D/F valve. Strangely enough, no hum is encountered

even though heaters are not symmetrical about earth and the H.T. is only half-wave rectified.

B. HUTCHINGS.

R.A.F., India Command.

#### Shortage of Engineers ?

DURING the Long Vacation a number of eminent gentlemen sieze their fountain pens and write to the newspapers to say that there is a shortage of engineers and that more should be trained in some new and revolutionary way. Engineers who are looking for a job find no trace of this shortage; indeed, if they rely on the Professional Engineers' Appointments Bureau they become convinced that there is a shortage of jobs.

In the radio industry the real shortage is in the supply of technical assistants; men who can wire up a circuit and test it are not in the laboratories nowadays. Consequently the engineer, who should be designing circuits and getting on with the real basic work, is forced to make his own chassis, drill his holes and wire the thing up himself. Second-rate circuits are used, because if the engineer sits down to do the theory there is no one to get on with the job.

The real reason why this shortage exists is obscure. Partly it is purely economic; because the engineer is badly paid, the assistant must receive even less. Partly it is due to educational snobbery on the part of the managements; the assistant has no degree, so he must be permanently labelled as of inferior status. Partly it arises from the excess of engineers, who cannot assert their need for assistance for fear of becoming unemployed.

There is an urgent case for a reduction in the number of engineers and for the abolition, beginning in the Civil Service, of the idea that a degree is *essential* for promotion beyond a certain level. The man with a degree should be expected to give a

better performance, because he is starting with better equipment, but his training should be used to the best advantage by making him delegate any work which can be done by an unqualified man to an assistant who has pride in his work and hope for the future.

THOMAS RODDAM.

#### Against V.H.F. Broadcasting

THE report on B.B.C. experimental F.M. transmissions at 45-Mc/s and 30-Mc/s makes it opportune to stress one aspect of V.H.F. broadcasting which is often overlooked. The service area of a 90-Mc/s station is a circle of radius about 50 miles centred on the transmitter. Consequently a listener can receive only his local station or stations. If V.H.F. is all it is claimed to be, the average listener will probably be content with a receiver which will only receive the V.H.F. bands; this is the beginning of a spiral, for as the listeners on medium frequencies are reduced in number the service may be reduced, with further economic pressure by the set-makers towards the V.H.F.-only receiver.

The political implications of this situation are important. A V.H.F. system has all the monopoly disadvantages of a wired wireless system. We cannot compare British programmes with foreign programmes and we cannot compare British news with foreign news. No longer can nation speak peace unto nation. Broadcasting would become a narrow nationalistic or even parish-pump affair. It would lack the flavour of broad and tolerant internationalism that should be inherent in a service on long-range frequencies, with a potentially international audience.

*Wireless World* has always opposed extensions of wired wireless schemes; it seems desirable to extend this opposition to V.H.F. broadcasting, and to urge that a solution of the medium wave overcrowding problem should be sought, possibly on the lines of common regional programmes with the announcements in several languages.

"RADIOPHARE."

# Virtually Distortionless

## A.D/47 AMPLIFIER

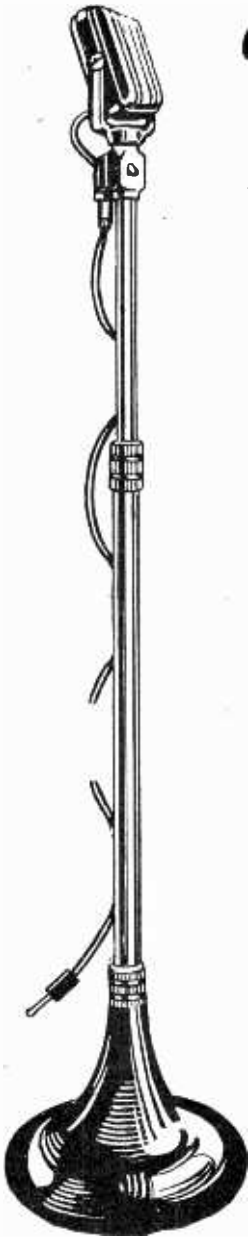

Less than one five hundredth the usual accepted figure (.01% total) even with speaker or cutting head inductive load applied.

This figure includes the noise of microphone input transformer, high gain stages and output transformer, etc.

Built in switched record compensation network for different listening levels, overload indicator and switched output for cutting head and speaker.

Send for full details of Amplifier type AD/47.

*Vortexion*  
LIMITED

257/261, THE BROADWAY,  
WIMBLEDON, LONDON,  
S.W.19.

Telephones: LIBerty 2814 and 6242/3.  
Telegrams: "VORTEXION, WIMBLE, LONDON."

# Study television at its source! ★



★ read about  
this new  
opportunity

**E.M.I. Research and Development** Laboratories were largely responsible for the Marconi-E.M.I. system of television transmission used by the B.B.C. Service—the first in the world.

**E.M.I. Factories** produce the finest television receivers in the world.

**E.M.I. Service** department is the largest and most expertly equipped in the country.

**NOW—E.M.I.** have set up a TRAINING ORGANISATION to provide immediate courses on practical TELEVISION (Postal and College Courses.)

**SOON** this new Training College will extend its syllabus to cover all branches of Electronic Science.

**This is your** opportunity to secure a thorough training in Television from the very pioneers of the Science.

Ask your local H.M.V. dealer for further details or send for our free pamphlet which gives full details of this and other courses.

*Associated Company of:*

THE GRAMOPHONE CO. LTD.  
("HIS MASTER'S VOICE")  
THE MARCONIPHONE CO. LTD.  
MARCONI-E.M.I. TELEVISION CO. LTD.  
RADIOMOBILE LTD., ETC. ETC.

## E.M.I. INSTITUTES, LTD.

Dept. W.W.2 · 43 GROVE PARK ROAD · CHISWICK · LONDON · W.4

**SCIENTISTS DEMAND . . .**

**SCIENTISTS BUILD . . .**

# Wego CAPACITORS

No matter what your problem in Radio or Electronics, we will create the Capacitor to fulfil your exacting demands and specification. Our technical and scientific advice is at your disposal.

**WEGO CONDENSER COMPANY LIMITED**

BIDEFORD AVE · PERIVALE · GREENFORD · MIDDX · Tel. PERIVALE 4277



Design Data (9)

# VIDEO AMPLIFIER H.F. RESPONSE

## III.—Mixed Series—Shunt Corrector

THE two correctors described in I and II (Design Data Nos. 7 and 8) can be used in combination to form a single coupling having two correcting inductances. The performance obtainable is a considerable improvement over the simpler circuits, but in spite of this the circuit is less widely used. This is partly because it demands more components, but chiefly because the values of the components are more critical.

In practice the main use of the circuit is in cases where the value of coupling resistance permissible with the simpler arrangements is just not high enough either for the requisite amplification or for the output needed. The increase of resistance possible with this circuit then sometimes permits the saving of a valve.

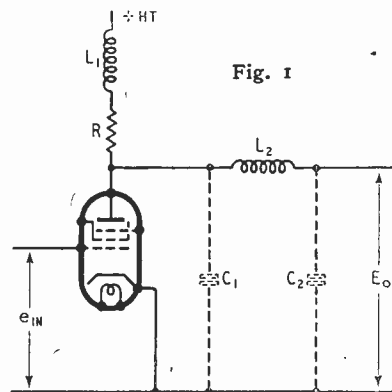

Fig. 1

### Assumptions

That the anode A.C. resistance of the valve is very large compared with R and that the resistance and self-capacitances of  $L_1$  and  $L_2$  are small enough to be ignored over the range of frequencies considered.

### Conditions

The formulæ are derived for the condition of flattest frequency response, curves A, and for critical damping, curves B.

### Symbols

- $E_0$  = output voltage.
- $e_{in}$  = input voltage.
- $A$  =  $E_0/e_{in}$  = amplification.
- $g_m$  = mutual conductance.
- $R$  = coupling resistance.
- $L_1$  = Shunt correction inductance.
- $L_2$  = Series correction inductance.
- $C_1$  = total capacitance on input side of  $L_2$ .
- $C_2$  = total capacitance on output side of  $L_2$ .
- $C$  =  $C_1 + C_2$ .
- $f$  = maximum frequency required.
- $t$  = time.

### Units

mA/V; k $\Omega$ ;  $\mu$ H; pF; Mc/s;  $\mu$ sec.

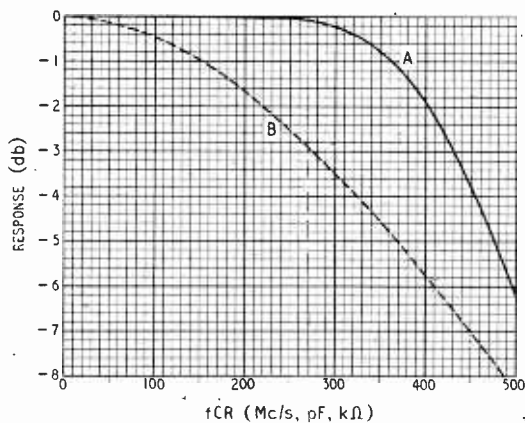

Fig. 2

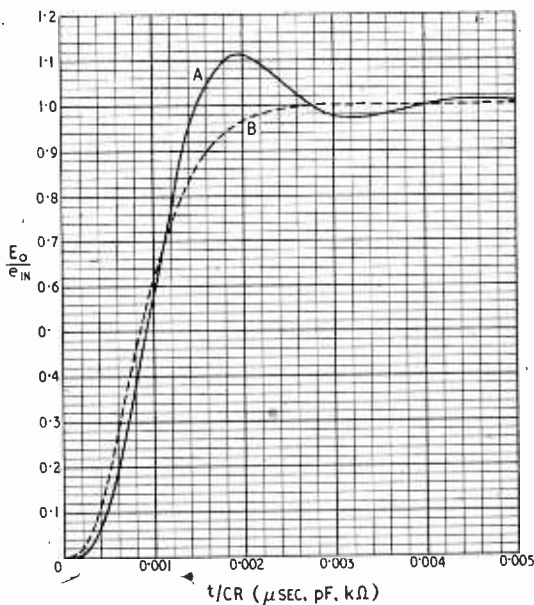

Fig. 3

### Procedure

Given the drop in response (db) required at a maximum frequency  $f$ , and the total circuit capacitance  $C$ , to find the other circuit values:—

- (a) For the flattest frequency response
  1. Determine  $fCR$  from curve A, Fig. 2.
  2.  $R = (fCR)/fC$ .
  3.  $A = g_m R$ .
  4.  $L_1 = CR^2/7$ .
  5.  $C_1 = 48C/119$ .
  6.  $C_2 = C - C_1 = 71C/119$ .
  7.  $L_2 = 289 L_1/71$ .

**Design Data—***(b) for critical damping.*

1. Determine  $f_{CR}$  from curve B, Fig. 2.
2.  $R = (f_{CR})/fC$ .
3.  $A = g_m R$ .
4.  $L_1 = CR^2/16$ .
5.  $C_1 = C/5$ .
6.  $C_2 = C - C_1$ .
7.  $L_2 = 25L_1/4$ .

Alternatively, given the response required at a given time  $t$  after the onset of a pulse:—

*(c) for the flattest frequency response.*

1. Determine  $t/CR$  from curve A, Fig. 3.
2.  $R = t/C(t/CR)$ .

Then proceed as in (a) 3-7.

*(d) for critical damping.*

1. Determine  $t/CR$  from curve B, Fig. 3.
2.  $R = t/C(t/CR)$ .

Then proceed as in (b) 3-7.

**Examples**

Let  $C = 40$  pF and a response of  $-1$  db at 3 Mc/s be required. Then for the flattest frequency response, from Fig. 2,  $f_{CR} = 360$  and so  $R = 360/(3 \times 40) = 3$  k $\Omega$ . If  $g_m = 6$  mA/V,  $A = 18$ . From (a)

$$4 - 7, L_1 = 40 \times 3^2/7 = 51.3 \mu\text{H}; C_1 = 48 \times 40/119 = 16.1 \text{ pF}; C_2 = 40 - 16.1 = 23.9 \text{ pF}; L_2 = 289 \times 51.3/71 = 208 \mu\text{H}.$$

If the requirement is for critical damping, but is otherwise the same, we use curve B of Fig. 2 and find  $f_{CR} = 157.5$  and the formulae then give  $R = 1.315$  k $\Omega$ ;  $A = 7.9$ ;  $L_1 = 4.34$   $\mu\text{H}$ ;  $C_1 = 8$  pF;  $C_2 = 32$  pF; and  $L_2 = 27$   $\mu\text{H}$ .

The transient response is given in Fig. 3. In the example above for the flattest frequency response, we use curve A. The output is 0.05 and 0.95 for  $t/CR = 0.000038$  and  $0.00014$  respectively, so that the output changes by 90 per cent for a change of  $t/CR$  of 0.0001112. With the above values  $t$  changes by 0.000112  $\times 40 \times 3 = 0.0135$   $\mu\text{sec}$ .

In the second case we use curve B and the values of  $t/CR$  are 0.000028 and 0.000184 giving a change of  $t/CR$  of 0.000156 corresponding to  $0.000156 \times 40 \times 1.315 = 0.0082$   $\mu\text{sec}$ .

It is to be noted that in all these correction circuits if the circuit values are chosen for a given drop in response at a given frequency, the condition of "flattest frequency response" leads to the higher gain, but the condition of critical damping gives a better transient response.

## ARMY BROADCASTING

### British and American Forces Networks

THE recent announcement that the B.B.C. is to take over in the near future the Forces Broadcasting Service, now conducted by the Army, affords an opportunity to review the present set-up.

The British Forces Network (B.F.N.) in Germany consisted of three 1-kW mobile transmitters until July last year, when a fourth transmitter at Norden, on the N.W. coast of Germany, was included. This 100-kW station was the Bremen transmitter which, with aerials directed to this country, was used for the "Lord Haw Haw" broadcasts. The transmitting site is actually some 75 miles from Bremen. Since September 15th this station has been replaced by a number of low-powered transmitters, such as Herford, on 1,366 kc/s, as it is now used for the B.B.C.'s European Service.

Forces in the Ruhr are served by a 20-kW mobile transmitter, working on 1,095 kc/s, at Tonisheide, near Dusseldorf. This self-contained German-built station is housed in 17 vehicles and trailers! During the war it saw service in Russia, Poland, North Africa and Italy.

The British Zone of Berlin is served by a 1-kW station working on 1,366 kc/s. A B.F.N. short-wave service is provided by a transmitter working on 7.29 Mc/s.

Three low-power networks are operated in Italy and Austria. The first is centred on Milan and operates on 565 kc/s, the second on Udine and the third on Naples (1,402 kc/s).

In addition to the networks in Europe, the Forces Broadcasting Service also operates a number of stations in Ceylon and the Middle East.

The Middle East Service is radiated by stations at Athens (601 kc/s), Beirut (1,080 kc/s), Jerusalem (795 kc/s and 7.22 Mc/s), Baghdad (870 and 957 kc/s), Cairo (950 kc/s), Suez (1,393 kc/s) and Benghazi (833 kc/s).

Troops in the South-East Asia Command are served by transmissions from the 100-kW short-wave station at Colombo, Ceylon, which radiates on 6.075, 9.52, 11.77, 15.12 and 17.77 Mc/s.

The American Forces Network, which started transmitting in this country in July, 1943, consisted for some months after D-day of a number of mobile stations on the Continent relaying programmes received by S.W. from London. A.F.N. was later controlled from Frankfurt.

The network, now consisting of one short-wave and eight medium-wave stations, is sub-divided into four groups with separate studios in

Frankfurt, Bremen, Berlin and Munich.

The Frankfurt network serves Central Germany and the Paris area, with, in addition, a short-wave service for troops stationed outside the U.S. Zone. The transmitters are Frankfurt, 10-kW, 1,411 kc/s; Beyreuth, 10-kW, 1,204 kc/s; Paris, 2-kW, 610 kc/s; and Munich, 50-kW, 6.080 and 8.565 Mc/s.

Southern Germany is served by the twin 100-kW transmitters in Munich and Stuttgart which are synchronized on 1,249 kc/s. The U.S. Zone of Berlin is served by a low-power station on 1,420 kc/s. Bremen (2-kW) operating on 1,429 kc/s and Bremerhaven (350 watts) on 1,500 kc/s serve the Bremen enclave.

A separate U.S. Army Air Corps station is operating from Wiesbaden on 1,584 kc/s.

The U.S. network in Austria consists of Vienna, 1-kW, 1,068 kc/s; Salzburg, 1-kW, 1,104 kc/s and 2-kW, 7.22 Mc/s; and Linz, 1-kW, 629 kc/s.

In Italy the American Expeditionary Stations (A.E.S.), a name introduced with the Allied landings in N. Africa, are still operating. The network consists of the following stations: Rome, 695 kc/s, Leghorn, 1,438 kc/s, Naples, 1,465 kc/s, Foggia, 1,500 kc/s and Gorizia, 1,510 kc/s. All these are 1-kW stations with the exception of Leghorn (350 watts).

The American Forces also operate transmitters in the Far East.

P. B. J.

# WHAT IS RADAR ? (AGAIN)

## Should it be Applied to Non-echo Systems ?

By "CATHODE RAY"

THE "again" is to propitiate the Editor for using his title.<sup>1</sup> Notwithstanding his masterly pronouncement on the subject (more propitiation!) the boundaries of the term "radar" still seem as ill-defined as those of my garden ever since the blitz. If anything, more so, for I am told that many people reckon such things as the Decca Navigator to be radar, whereas I would never think of picking pears from . . . well, anyhow, what is radar ?

At the I.E.E. Radiolocation

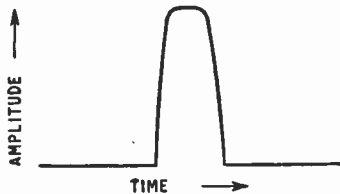

Fig. 1. Diagram of a pulse.

Convention, Sir Robert Watson-Watt, after explaining that he was going to use "radiolocation" to mean the British contribution to radar, set about defining it; inadequately, he said. The definition was, nevertheless, more than adequate for the Minister of Supply, who, during a pause for breath half-way through it, remembered an important engagement and made for the door. Now it is in print<sup>2</sup> (though, I suspect, in abbreviated form) it can be studied at leisure by those of us who got left hopelessly behind during the reading.

To clear away a possible source of misunderstanding at the outset, I would emphasize that Sir Robert's distinction between "radiolocation" and "radar" was just a matter of convenience for the purposes of his lecture, and offers no excuse for anybody to suppose that they differ technically. One can assume that his definition of "radiolocation" applies equally to "radar,"

"Diallist," like a good old British bulldog, prefers "radiolocation" to any imported product; though apparently even he is beginning to find its six syllables rather tiring to keep up all the time. The other reason for his choice is that, unlike "radar," it says what it means. While it certainly does make more sense to the man in the street, it is rather liable to make the wrong sort of sense. Even assuming that "location" means finding the position of something else, and not one's own position, only an arbitrary ruling could prevent "radiolocation" from including the locating of Zeppelins during the first World War; which was done, you may remember, by picking up their radio signals at two or more listening stations. Although there are differences of opinion on what the word "radar" stands for, all agree, I think, in expanding the last two letters into "and ranging." The fact that one letter out of only five is given to represent the little word "and" seems to emphasize that the measurement of range is the distinctive feature. It certainly is the heart of Sir Robert Watson-Watt's definition.

Even the broadest definitions of radar bring the velocity of radio waves into it, as the basis for measuring range by timing them. The normal method of identifying the waves for this purpose is by sending them out in small groups, loosely called "pulses." Why loosely? Because a pulse is something of which an amplitude/time diagram looks like Fig. 1; whereas the diagram of what is sent out from a radar station is like Fig. 2. In the absence of any existing name for the latter, Sir Robert was obliged to call it "a separately identifiable packet of radiated energy." (Sacrificing precise descriptiveness to brevity, my suggestion, for what it is worth, was "wave pulse"<sup>3</sup>). Resigning ourselves unashamedly

to being loose, however—radar has from the start been associated with pulses. So much so that the common semi-technical idea of radar seems to comprise anything that works by radio pulses. If there is any risk of this idea spreading, for any sake let us stick to "radiolocation," because that would at least be some protection from the absurdity of including pulse systems used for communication.

We must agree, surely that not all pulse systems are radar. But do all radar systems use pulses? Sir Robert says yes. Or at least, he specifically rules out "pure or modulated c.w. signals in which particular means for discounting the disturbances due to ionospheric reflection are not employed." That rules out Decca, of course, even if it were not ruled out on other counts. It also rules out frequency-modulated c.w. systems, such as those radio-

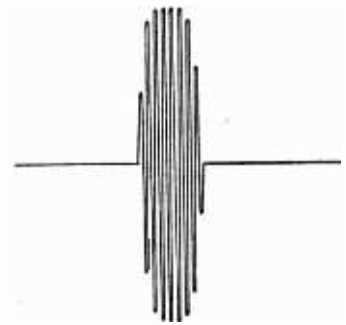

Fig. 2. Diagram of a . . . ?

altimeters that depend on the beat-note frequency between the waves being radiated and those returned, a little later, as echoes.

"Echoes." Yes, that raises a still more controversial issue. Sir Edward Appleton and the U.S. official publication *Radar—A Report on Science at War* (reprinted by H.M.S.O.), both regard echoes as essential to radar. I always used to; and so,

<sup>1</sup> *Wireless World*, October 1945, p. 289.  
<sup>2</sup> *Journal I.E.E.*, Part IIIA, No. 1, p. 11.

<sup>3</sup> *Wireless World* April 1946, p. 115.

### What is Radar (Again)—

I gather, did "Diallist," and I should think most of the other people whose wartime job was radar. The U.S. book specifically includes the frequency-modulated c.w. system just mentioned, calling it a *radar*-altimeter; so evidently does not insist on pulses. Where this book and Sir Edward Appleton diverge, however, is that the book evidently stretches the term "echo" to include return signals coming from a transmitter carried by the "target" and triggered into activity by the outgoing signal (as in IFF and Rebecca-Eureka, for example) whereas Sir Edward confines radar to systems that work "without the co-operation of the thing detected"; i.e., by genuine reflection.

Going back to Sir Robert Watson-Watt; his definition covers three distinct classes of systems, which he enumerates. First there is what he calls primary radar—the true echo type, "useful against icebergs and enemies generally." Then there is secondary radar, requiring "that small measure of co-operation which is involved in the fitting and switching on of an otherwise automatic responder." Thirdly, radar navigation. In this he includes things like Rebecca-Eureka (rather illogically, surely, as they are included already under secondary radar), and also Gee and Loran, in which there is no return signal at all.

A possible reason why Sir Robert insists on pulses or "packets" in his definition now appears: it is the only way of including Gee (which certainly does employ radar techniques very largely) without bringing in Decca (which, although fundamentally the same, except for c.w. in place of pulses, is quite different in technique).

So we have the three schools of thought: the Appleton school, restricting radar to methods of locating things without their voluntary co-operation, by means of echoes; the U.S. booklet school, which adds responder systems; and the Watson-Watt school, which adds Gee and Loran. The first two, not having Gee and Loran to think about, are indifferent to whether pulses are

used or not. The U.S. school seems illogical in rejecting Gee on the ground that echoes are not used, while including responder systems. The Appleton school, which probably most of us feel is strictly correct in theory, becomes a trifle artificial in practice, because so much of the equipment used for responder systems (and to a large extent Gee and Loran, too) is similar in technique if not actually identical. IFF, for example, was so deeply embedded in radar that few can ever have thought of it as outside its scope. The Watson-Watt terms "primary radar" and "secondary radar," by drawing that much distinction between genuine echo systems and those that in all fundamental respects are similar except that the "echo" is locally generated instead of being a reflection, supply the logical justification for the second school.

But Watson-Watt's third stage seems more dubious. It brings in systems that have little in common with echo radar except some of their techniques. They do not locate anything but themselves;

there is no return journey, echo or otherwise; transmitter and receiver are at opposite ends; two stations of known fixed position are required (as in ordinary DF); and the time and velocity data give, not a distance, but only a difference in distance, like other systems that admittedly have nothing to do with radar. Incidentally, the titles of the specialized papers following Sir Robert's introduction to the Radiolocation Convention refer to Gee as "A Radio Navigational Aid," whereas H.S. is "A Radar Navigation and Bombing Aid."

I wonder if anybody else visualises a radar set as a sort of chameleon that locates things by shooting out its tongue at them and then drawing it back again, as quick as a flash, when it makes contact? "Secondary radar" can be admitted to this picture by supposing that the end of the tongue gets bitten by the thing it touches. The main thing is the self-sufficiency of the reptile. It just sits and locates.

Is it because I am chameleon-minded that I find it difficult to think of Gee as radar?

## NEW VALVE TESTER

### Measurements Under Operating Conditions

MANY unusual features are included in the latest Service Valve Tester made by Everett Edgcombe and Co., Colindale Works, Hendon, London, N.W.9. It is designed for operation from

A.C. mains and provides variable D.C. supplies for anode, screen and control grid, so that tests can be made under any given working conditions. In addition to the usual mutual conductance and emission measurements, there is provision for testing grid current and low vacuum, interelectrode insulation, heater-cathode insulation, thyratron emission and control ratio, and rectifier or diode emission.

Connections to the valve sockets are made by wander plugs so that any system of valve base connection can be accommodated. In addition to existing sockets there are spaces for new types.

The price of the valve tester is £19 15s. or, with the addition of a control panel for multi-range A.C. and D.C. measurements, £28 17s 6d.

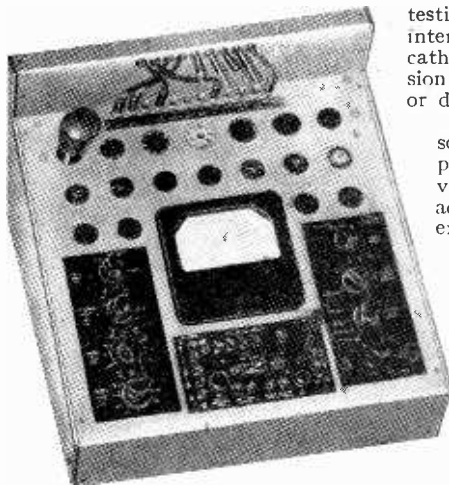

Everett Edgcombe Service Valve Tester.



# BELLING-LEE QUIZ (No. 6)

Answers to a selection of questions we are continually being asked by letter and telephone

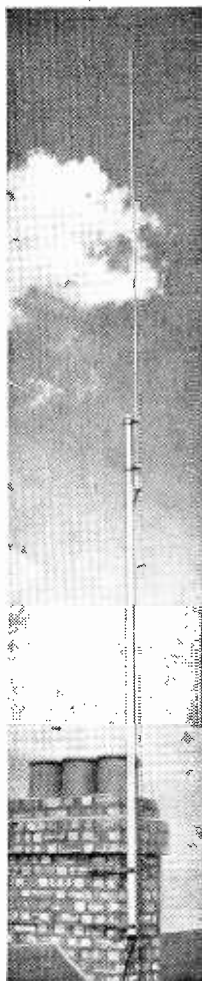

The illustration shows "SKYROD" L.370/LK on a mast lashed to chimney stack. Masts are normally supplied by us, but are not at present available in large quantities and we ask prospective buyers to obtain their masts locally if possible. Each "SKYROD" has a lightning arrester incorporated in the "Eliminnoise" transformer.

**Q.25.** *If an aerial has been up for several years will it need an overhaul?*

**A.25.** Belling-Lee aerials, both Skyrod and television, are normally made of steel, zinc plated and "passivated" to improve corrosion resistance. Even under ideal conditions you couldn't expect much zinc to be left after six or seven years. These aerials are normally fixed directly in the sulphurous fumes from chimneys, and subjected to all weathers. The very conditions which accelerate corrosion. People often seem surprised when we tell them their aerials cannot last for ever, and when we point out that steel bridges

and lamp posts, park railings are all painted regularly. How much more necessary to protect a slender steel tube subjected to far worse conditions. Our recommendation is to have the aerial lowered once a year, certainly not less than once in two years, giving the whole thing, together with its lashings and brackets, a good coat of paint, bitumastic if possible. At the same time examine the feeder for chafing where it goes round corners, over gutters, etc.

If you are within the Greater London area the Belling-Lee installation department will quote you for this service.

**Q.26.** *Will a Skyrod\* aerial in an exposed coastal position withstand south-west gales?*

**A.26.** We know of many Skyrods in such locations, right on the sea front or on cliff tops, but no case has been reported to us of one breaking off through wind. We do know of a very few cases where a "Skyrod," through neglect, has rusted badly and bent over. Generally speaking a steel rod will stand up to a lot of punishment. In Enfield there is a Belling-Lee communication dipole on the roof of the Police Station. A land mine came down across the road demolishing a church and many houses, but the dipole was undamaged. It is surprising the number of vertical aerials standing on chimney stacks in Berlin, where the chimney stack is all that remains of the premises.

**Q.27.** *Precipitation Static—what is it?*

**A.27.** This is not a very good name, but it has become accepted as applying to any form of static caused by electric charges building up on an aerial quicker than they can leak away: the result is a form of corona. Aerial corona usually extends only a microscopic distance from the conductor, is usually invisible even in the dark, but is often audible near the conductor as a faint hissing sound. The condition is not common except in certain districts. We have reports from high locations round Sheffield, in parts of Yorkshire, on cliff top locations by the sea, etc. It may occur without rain when it is generally heard as a particularly violent hissing noise in the loudspeaker. Thundery weather is not essential. It is generally

accompanied by rain or hail, and is sometimes known as "rain static." This type is heard as a series of pops, the frequency of which varies, rising to a roar as the centre of the rain storm approaches. Temporarily earthing the aerial stops the noise, but it builds up again in a few seconds. The charges may be induced from clouds, or by charged raindrops. In dry locations the charge may be built up by the friction of sand or other particles being impelled upon the aerial. The trouble is serious on aircraft, and may result in the air services over vast areas being grounded while the condition persists. The condition came to the notice of some home listeners only after the advent of the more efficient Skyrod aerial. It is now becoming an occasional nuisance to television enthusiasts, who must use an efficient aerial; fortunately it is not frequent in London. So far our technical staff have only seen rain static splashes obliterating an unmodulated raster, and we anxiously await reports of the effect when a transmission is on.

We are not taking all this "sitting down." We have already done a lot of research, including the interrogation of German scientists, and of course a very thorough survey of all that has been written in other countries. The problem of the "ground aerial" is quite different from that on air-borne aerials. We are quite hopeful of success. We would welcome co-operation from our readers. Will those of you who are troubled in this way help us by keeping us advised as to conditions when the nuisance is observed. If you will undertake to help, please write for a questionnaire. It doesn't matter whether or not you use a Belling-Lee aerial.

**TO BE CONTINUED.**

\* Skyrod (Reg. Trade Mark).

Types L.355/CK 12' collector, downlead, 2 transformers, pole clamps and earth wire £7 2 6

L.355/LK with chimney lashings and brackets in addition £8 8 0

L.370/LK with chimney lashings for 2' mast in addition to L.355/CK £9 10 0

Also supplied with 18' collector.

**BELLING & LEE LTD**  
CAMBRIDGE ARTERIAL ROAD, ENFIELD, MIDDLESEX.

There is a TANNOY SPEECH BROADCASTING INSTALLATION to suit your requirements



*When Seconds Count..*



**TANNOY**

CALL SYSTEMS CREATE EFFICIENCY !

"Tannoy" is the registered trade mark of equipment manufactured by

**GUY R. FOUNTAIN, LTD.**

"THE SOUND PEOPLE"

West Norwood, S.E.27, and Branches  
Gipsy Hill 1131

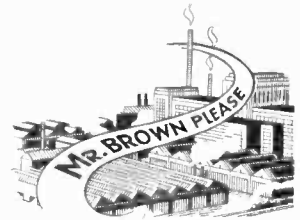
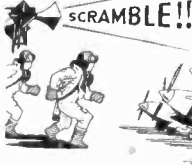

The largest organisation in Great Britain specialising SOLELY in Sound Equipment

# QUARTZ CRYSTAL UNITS



For your **FREQUENCY STANDARD**

TYPE JCF/200 LOW TEMPERATURE COEFFICIENT BAR

Frequency . . . 100 Kc/s  
Accuracy . . .  $\pm 0.1\%$   
Price on application.

Vacuum mounted for optimum stability. A high precision unit of extreme stability, the crystal being nodally mounted on fine wires soldered to the bar.

DELIVERY FROM STOCK

For your **TRANSMITTER**

TYPE 2 LOW TEMPERATURE COEFFICIENT PLATES

3-50/3-75 Mc/s or 7-00/7-50 Mc/s for the 30 Mc/s band.  
3-66/3-75 Mc/s or 7-32/7-50 Mc/s for the 60 Mc/s band.

Prices on application.

Supplied for either band for random frequencies or for specified frequencies at slightly increased price.  
AVAILABLE FOR IMMEDIATE DELIVERY



**SALFORD ELECTRICAL INSTRUMENTS LTD.**

PEEL WORKS, SALFORD 3

Telephones : BLAckfriars 6688 (6 lines).

Telegrams and Cables : "SPARKLESS, MANCHESTER"

Proprietors: **THE GENERAL ELECTRIC Co. Ltd., of England**

# TELEVISION SOUND REJECTION

## Avoiding Interference from the Sound Channel

By W. T. COCKING, M.I.E.E.

ONE of the most important factors to consider in television sound reception is the avoidance of interference between the sound and vision channels. There is usually little difficulty in obtaining a sound output which is free from the vision signal, but it can be exceedingly difficult to obtain a vision output free from the sound signal.

The sound and vision mid-band frequencies are 41.5 Mc/s and 45 Mc/s — a separation of 3.5 Mc/s. The bandwidth needed for the sound channel is small enough to be ignored in the present discussion, but that of the vision channel is very large. As a minimum for present-day requirements it should be 4 Mc/s, and the ideal to be aimed at is 6 Mc/s, assuming the usual double-sideband reception.

This means that for the minimum requirement the response must be flat within  $\pm 1.5$  db from 47 Mc/s to 43 Mc/s, but should drop to about  $-40$  db at 41.5 Mc/s. This entails a drop in response of some 40 db for a change of frequency of 1.5 Mc/s. In the ideal case, the

figures become a response within  $\pm 1.5$  db from 48 Mc/s to 42 Mc/s, with a drop to  $-40$  db at 41.5 Mc/s—a change of 40 db in 0.5 Mc/s. The general shape of the resonance curves in these two limiting cases can be seen from Fig. 1.

The usual practice in receivers is to use tuned circuits as inter-valve couplings. However, the requirements of bandwidth and selectivity are mutually conflicting, and it is not possible by any simple combination of such circuits alone to meet the requirements of a television set. Higher selectivity for a given bandwidth is obtainable with band-pass type couplings, but in the simpler varieties this is mainly because the total number of tuned circuits is greater.

It is necessary, therefore, to include circuits specifically for the rejection of the sound signal. In

some cases such circuits are combined with band-pass type inter-valve couplings, and they are then not always obvious as such, but appear to form with the coupling elements merely a rather complicated-looking filter.

It is very easy to secure adequate rejection of the sound signal with one or two retractor circuits. It is by no means so easy, however, to prevent these circuits from affecting the pass-band characteristics of the vision channel.

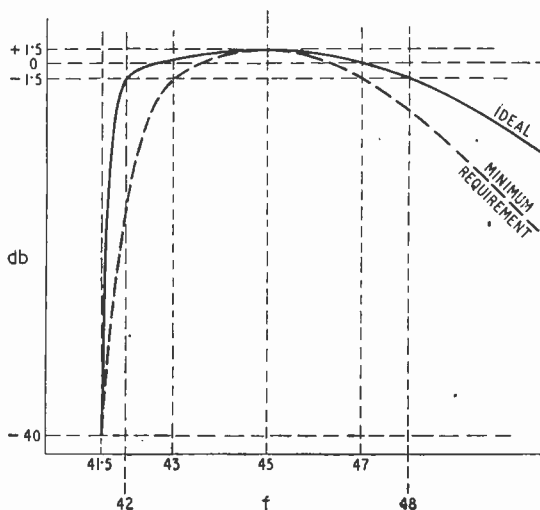

Fig. 1. Idealized resonance curves for 4 Mc/s and 6 Mc/s bandwidths are shown here.

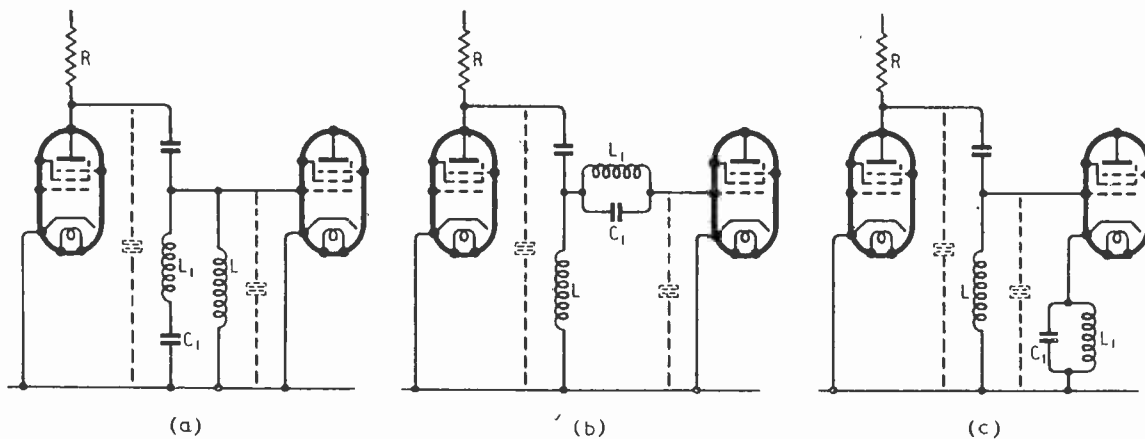

Fig. 2. Three sound-rejection circuits are indicated by  $L_1C_1$  in each case. The main coupling is  $L$  and  $C$ , the latter being the sum of the various dotted capacitances.

**Television Sound Rejection—**

Conditions are most difficult in this respect when the receiver is a straight R.F. amplifier, for the performance of resonant circuits depends on frequency ratios, not frequency differences. In the ideal case it is necessary to have good response at 42 Mc/s and very small response at 41.5 Mc/s; the change of 0.5 Mc/s represents a ratio of 1:0.99, approximately.

In a superheterodyne with an intermediate frequency of 13 Mc/s the limit of the band would be 10 Mc/s and the sound channel could be 9.5 Mc/s, making the ratio 1:0.95. This considerably eases the problem of sound rejection and is one of the major advantages of the superheterodyne. However, its disadvantages are such that straight R.F. amplification is often to be preferred.

This is not the place to enter into a discussion of the relative merits of the two types of re-

ceiver, for we are here concerned with the subject of sound rejection. This will be discussed on the basis of a straight set, but it should be remembered that the same methods apply, and are still

necessary, in the superheterodyne, but that it is rather easier to obtain adequate rejection. A single tuned circuit, damped by a shunt resistance, is usually adopted as an intervalve coupling and the resonance frequencies of the circuits in different stages are staggered about the mid-band frequency in order to secure greater bandwidth. Such an amplifier requires a minimum of material and is simple to adjust; it also gives greater gain per stage than other systems of equal simplicity of adjustment.

**Rejector Circuits**

With such couplings there are three main forms of sound-channel rejector—the acceptor circuit, Fig 2 (a), the rejector (b), and the cathode rejector (c). In every case the components of the sound rejector are lettered  $L_1, C_1$  and the coupling inductance is  $L$ , with a damping resistance  $R$ . The capacitance tuning  $L$  is the total circuit stray capacitance shown dotted; its value is 20-30 pF. The values  $L_1, C_1$  are chosen to resonate

pedance is then the series R.F. resistance of the circuit; if this is  $r_1$  and it is much smaller than  $R$ , the relative response at sound and vision frequencies is nearly  $r_1/R$ . Now 40 db is a ratio of 100:1, and  $R$  is often about 2,000  $\Omega$ , so that  $r_1$  should be no more than 20  $\Omega$ . There is no difficulty in achieving a resistance of this order, or much lower, with a coil of normal inductance, and the circuit is, in fact, an extremely effective sound rejector.

Unfortunately, it has a large effect within the vision channel when practicable values of components are used. If  $L$  and  $L_1$  are of the same order of magnitude, then  $C_1$  is of similar capacitance to  $C$ —the total shunt capacitance across  $L$ . At frequencies well above its resonance with  $L_1$ ,  $C_1$  has only a small reactance and  $L_1$  becomes almost in parallel with  $L$ . The total inductance becomes about one-half the normal and the maximum response of the coupling is shifted nearly 25 per cent above its proper frequency—to around 60 Mc/s.

To avoid this  $L_1$  should be large compared with  $L$ , which means  $C_1$  small compared with  $C$ .

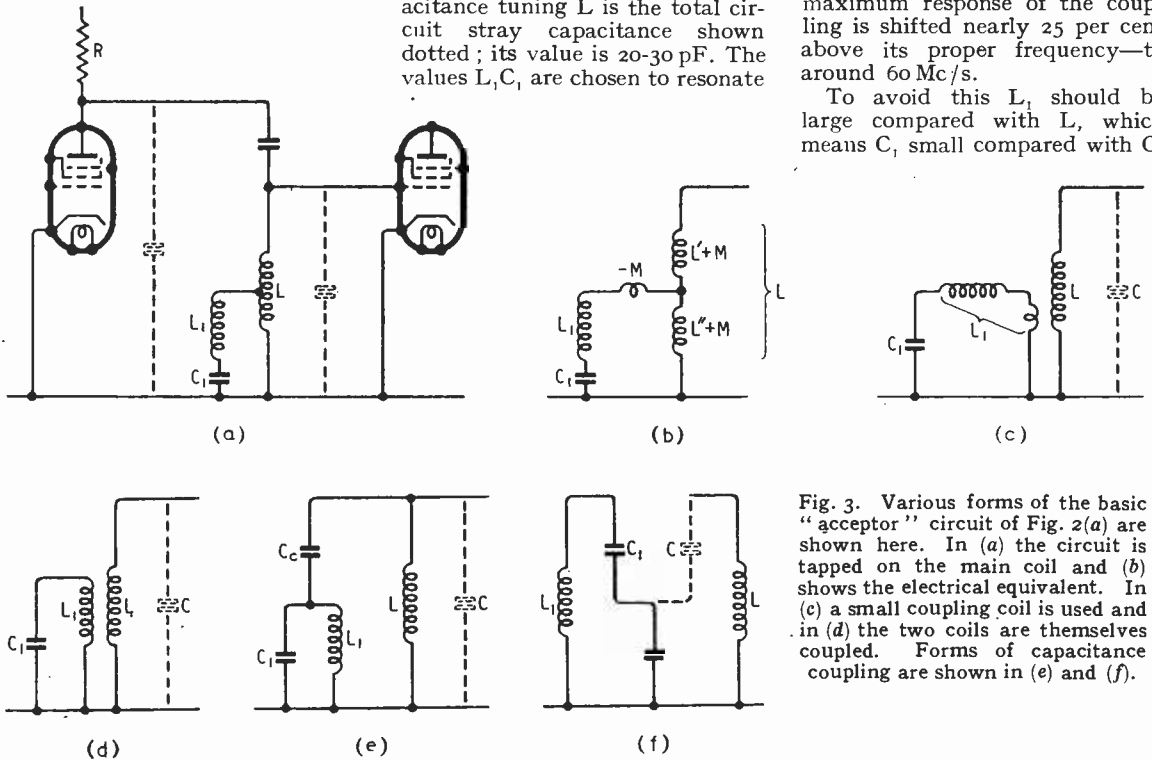

Fig. 3. Various forms of the basic "acceptor" circuit of Fig. 2(a) are shown here. In (a) the circuit is tapped on the main coil and (b) shows the electrical equivalent. In (c) a small coupling coil is used and in (d) the two coils are themselves coupled. Forms of capacitance coupling are shown in (e) and (f).

at the sound channel, 41.5 Mc/s in a straight set. In Fig. 2 (a), the acceptor circuit works by effectively short-circuiting the coupling at its resonance frequency. The only im-

As the latter is only 20-30 pF, this means that  $C_1$  should be 2-3 pF as a maximum and preferably less. It cannot be as small as this, however, because of the self-capacitance of  $L_1$ . The inductance

As the latter is only 20-30 pF, this means that  $C_1$  should be 2-3 pF as a maximum and preferably less. It cannot be as small as this, however, because of the self-capacitance of  $L_1$ . The inductance

$L_1$  must not be so large that its resonance with its self-capacitance occurs at or higher than the frequency of the sound channel.

Practically speaking, this particular circuit is useless under television conditions. There is, however, one way out. The acceptor need not be connected across the whole of  $L$ , but can be tapped down it, as shown in Fig. 3(a). If there is perfect coupling between the different parts of  $L$  the performance of Fig. 3(a) is the same as that of Fig. 2(a), when in the former  $L_1$  is multiplied by  $n^2$  and  $C_1$  and the self-capacitance of  $L_1$  are divided by  $n^2$ , where  $n$  is the ratio of total turns on  $L$  to the turns between the tapping and earth.

### Tapped Acceptor

Now convenient practical values for  $L_1$  and  $C_1$  in Fig. 3(a) are about the same as  $L$  and  $C$ ; that is,  $C_1$  would be around 20-40 pF and the self-capacitance of  $L_1$  would be 2-5 pF. Now if the tapping is arranged so that  $n^2 = 10$ , then in the equivalent circuit of Fig. 2(a)  $L_1$  becomes about ten times  $L$ ,  $C_1$  is some 2-4 pF, and the effective self-capacitance of  $L_1$  is only 0.2-0.5 pF. This is an impossibly low value to achieve in the actual circuit of Fig. 2(a).

The gain by tapping the acceptor circuit down  $L$  is achieved only by virtue of the fact that the self-capacitance of a coil does not vary much with the inductance. If in varying  $L_1$  the self-capacitance varied inversely, we should gain nothing, but in fact it is nearly independent of  $L_1$ . There is actually some tendency for it to increase as  $L_1$  is reduced, but it is small enough to be ignored here.

We do, however, lose on rejection, for the series resistance of  $L_1$  is transformed in the ratio  $n^2$ , so that instead of the figure of 20  $\Omega$  calculated above as permissible, it must be 2  $\Omega$  only in Fig. 3(a) when  $n^2 = 10$ . This is by no means difficult to obtain at the frequency in question, however.

When the coupling between the different parts of  $L$  is imperfect, as it always is in practice, the most important practical effect is to make the tuning of  $L_1 C_1$  dependent on the inductance of  $L$ . The equivalent circuit for imper-

fect coupling is shown in Fig. 3(b) in which  $L'$  and  $L''$  are the inductances of the two parts of  $L$  above and below the tapping respectively, each being measured

to the tapping point. The equivalent circuit as in Fig. 3(c), which also has an equivalent form (f) which is more obviously analogous to (b). It should be noted that (e) is identical in circuit to

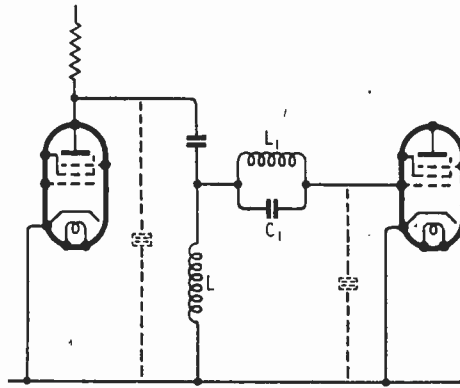

(a)

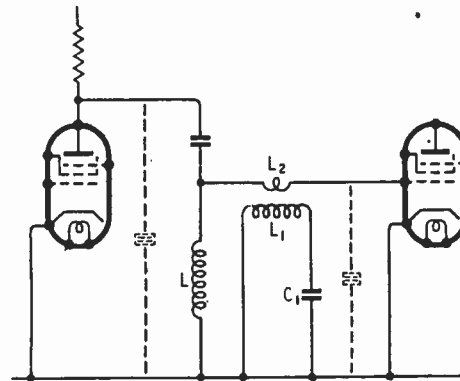

(b)

Fig. 2(a) when account is taken of the capacitance across  $L_1$  in the latter. It thus suffers from the drawback of demanding a very small value for  $C_0$ . It is to be noted that the series resonance for the rejection frequency is not between  $C_0$  and  $L_1$  alone, but between  $C_0$  and the apparent inductance of  $L_1$  in the presence of  $C_1$ . The frequency is determined by  $L_1(C_1 + C_0)$ . For the circuit to have negligible effect in the vision band  $C_0$  must be very small compared with  $C_1$ . In general  $C_0$  should not exceed about 1-2 pF.

It is inconvenient to make such a small capacitance variable, and it is unnecessary, for tuning can equally well be carried out by  $C_1$  or  $L_1$ .

There is one effect of importance which is

Fig. 4. The "rejector" circuit of (a) is inconvenient since it is not earthed. The form (b) is more useful.

independently, and  $M$  is the mutual inductance between them. It will be clear that the tuning of the acceptor circuit  $L_1 C_1$  will be affected by the inductance of  $L$ , so that if the latter is variable for tuning the main circuit it will affect the trap.

### Coupled Acceptors

Other equivalent circuits are shown in Fig. 3(c) and (d). The former merely uses a small coupling coil to  $L$  instead of an actual tapping, and in the latter  $L$  and  $L_1$  are coupled directly. Which circuit is selected depends chiefly on mechanical convenience and Fig. 3(d) is sometimes advantageous because the two coils can be wound on the same former.

It is possible also to use capa-

present in all these circuits, but which is most readily understood from the simplest circuit of Fig. 2(a). This is the fact that in addition to the series resonance at the sound-channel frequency and the parallel resonance in the vision channel, there is an unwanted parallel resonance at a frequency lower than that of the sound signal. This gives a relatively high response below the sound signal but it cannot be avoided; all rejection circuits give the same or similar effects. Because of it, it is most unwise to use sound rejectors in every coupling; only as many as are needed to avoid sound-channel interference should be used.

Referring to Fig. 2(a), it is clear that the branch LC is in-

**Television Sound Rejection—**

ductive at all frequencies below its resonance in the vision channel and capacitive for all higher frequencies. Below its resonance at the sound frequency, the branch  $L_1C_1$  is capacitive and above it is inductive. As the frequency is raised from zero to that of the sound signal the capacitive reactance of  $L_1C_1$  must pass through all values from infinity to zero, so that there must be some frequency at which it equals the inductive reactance of  $LC$ . At this frequency the circuit as a whole has a parallel resonance, and it is below the sound-channel frequency.

Above this the whole circuit is capacitive and stays so until the resonance of  $L_1C_1$  is passed. After this the  $L_1C_1$  branch is inductive and so is the  $LC$  branch, so that the whole circuit is inductive. As the frequency rises the inductive reactance of  $L$  and the  $L_1C_1$  branch increases and the capacitive re-

arrangement of Fig. 4(b) in which the rejector circuit itself is  $L_1C_1$  and is earthed and coupled to the coil  $L_2$  in the grid lead. Only the interwinding capacitance then comes across the intervalve coupling and this can be made very small. The effectiveness of the circuit is much the same as with the arrangements of Fig. 3. Practically it is often less convenient since it may lengthen the grid lead of the valve unduly.

The third form of rejector is the cathode-circuit of Fig. 2(c). It operates by producing negative feedback at the parallel resonance frequency of  $L_1C_1$ . If this circuit has a dynamic resistance  $R_d$  at this frequency, then the rejection ratio is roughly  $1 + gR_d$  where  $g$  is the mutual conductance of the valve with screen and anode strapped. A dynamic resistance of  $2\text{ k}\Omega$  with a mutual conductance of  $7\text{ mA/V}$  gives a rejection ratio of about 15 times, or 23.5 db. In fact, it will be less because the

of the circuit  $LC$  and the mutual conductance of the valve. In general, when using this circuit it is necessary to damp  $LC$  more heavily than would otherwise be necessary and even then oscillation may occur during adjustment. That is to say, the conditions may be such that the circuit is quite stable when  $L_1C_1$  is adjusted properly for sound rejection, but it may be unstable if it is tuned to a higher frequency, as it may well be when just putting a set into operation. There is no real harm in this, but it does make the adjustment more difficult. Another disadvantage of the circuit is that it lengthens the cathode lead of the valve and so affects the input impedance.

All the circuits discussed have their uses and it is not possible to say that one is generally better than another. Much depends on the general arrangement of the set. The writer has found, however, that the circuit of Fig. 3(c) is especially convenient in that it is simple, gives good rejection, has very little effect on the capacitance or inductance of the main coupling, and has connections of relatively low impedance. This last point means that the leads to the rejector coil and capacitor proper do not have to be inconveniently short, or of especially low capacitance to earth.

It may be remarked that the use of rejector circuits greatly modifies the alignment procedure and circuit damping of a stagger-tuned amplifier. Without rejectors, the damping and resonance frequencies of the individual circuits are readily calculable, but these values do not hold with rejector circuits.

The reason is that it is impracticable to make the effect of a rejector negligible around 42-44 Mc/s, whereas it is of little effect at higher frequencies. On the low-frequency side of the vision carrier the rejectors make the response drop off much more than on the high-frequency side. This can be corrected by tuning more of the intervalve couplings to the low-frequency side than to the high and damping one or more of them less heavily.

In one amplifier having five coupling circuits and two rejectors, the writer found it desirable

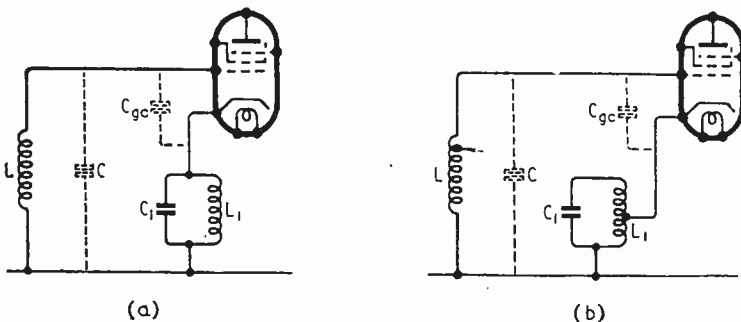

Fig. 5. The cathode-rejector circuit showing the grid-cathode capacitance of the valve which has a considerable effect on the performance.

actance of  $C$  falls. At a frequency in the vision channel there is parallel resonance again and at all higher frequencies the circuit is capacitive.

Another form of rejector is shown in Fig. 4 (a) and consists of a parallel tuned circuit inserted in series with the grid of the valve. In this case it is desirable for  $C_1$  to be large compared with the other capacitances and  $L_1$  is correspondingly small. This form of the circuit is undesirable in practice because of the capacitance of  $L_1$  and  $C_1$  to earth; this comes across the coupling circuit and so increases the capacitance of this circuit.

It is usually better to adopt the

effect of  $L_1C_1$  is not negligible in the vision band. A high capacitance is needed to reduce the effect in the vision band and it is more convenient to obtain the equivalent of this by connecting to a tapping on the coil as in Fig. 5(b) than to use a large value itself.

The operation of the circuit is greatly complicated by the grid-cathode capacitance  $C_{gc}$  of the valve. This is shown in Fig. 5(a) and (b) and when  $L_1C_1$  is capacitive, as it is over the vision channel, the circuit has the form of a Colpitts oscillator. Whether or not it oscillates depends on the relation of  $C_{gc}$  to the effective capacitance of  $L_1C_1$ , the damping

to tune three circuits below 45 Mc/s and two above and also to damp two of the former only relatively lightly. The response curve obtained was flat within  $\pm 1.5$  db from 42.5 Mc/s to 48 Mc/s, taking 45 Mc/s as zero db.

It should be noted that the rejector circuit, being tuned to the sound signal, forms a convenient point for picking it out to feed the sound channel. It is common to make the first two stages operative on both sound and vision, and in the circuits of Fig. 3(a-e) the sound signal developed across  $C_1$  can be utilized merely by connecting the grid of the first sound-channel amplifier to the junction of  $L_1$  and  $C_1$ . This applies also to Fig. 3(f), but here it is the voltage across  $L_1$  that is employed.

The rejector of Fig. 4(b) can also be used and also the cathode circuit of Fig. 5.

It is particularly to be noted that the tuning of  $L_1C_1$  for maximum rejection does not coincide with the tuning for maximum input to the sound channel. The former occurs at a series resonance the latter at a parallel. The two are close together and the input to the sound channel does not vary greatly between them, but the effect on the vision channel is large.

When adjusting such a circuit, therefore, it is important to remember that it must be adjusted for maximum rejection of the sound signal from the vision channel, not for the greatest signal in the sound channel.

## BOOK REVIEW

**To Be An Engineer.** By Lt.-Col. J. R. W. Murland, B.Sc. (Eng.), A.M.Inst.C.E., A.M.I.E.E. Pp. 180 + xii. Methuen and Co., Ltd., 37, Essex Street, London, W.C.2. Price 7s 6d.

There can be few prospective careers on which it is so difficult to write a book of advice as engineering. The field is almost as wide as civilized life; and as a vocation it is ill-defined.

The author of "To Be An Engineer" has in view the engineer in the professional sense, and defines him as a person who has been elected a corporate member of one of the three main engineering institutions—Civil, Mechanical or Electrical. He has succeeded admirably in his aim of concentrating on aspects common to all branches of engineering.

In this connection, the problem of how to get a broad general engineering education without overloading the brain with subject matter irrelevant to the particular branch in view is one that has often been discussed. Col. Murland gets to the root of the matter in few words: "... no general knowledge is ever unnecessary; what must be avoided is the acquisition of detailed knowledge that will never again be required... knowledge consists less of knowing facts than of knowing where facts can be found and of being able to assess them at their real worth."

Half of the book consists of straightforward guidance on what engineers are and do, their responsibilities and rewards, the personal

qualities and training necessary, the cost of the various schemes of training, and the later career. The other half supplies details, in the form of appendices, of such matters as syllabuses of association membership and London external B.Sc. (Eng.) examinations; universities, technical colleges, and other schools of engineering, and the examinations for which they prepare; a typical form of apprenticeship indenture; the scheme for assisting the demobilized in their training; and fees and regulations for corporate membership of the engineering institutions.

All this material is so well arranged that the author might well have been excused if he had followed the common practice with books of this kind and omitted an index altogether; on the contrary, he has provided an unusually detailed one.

Anybody thinking of becoming a professional engineer will find in this book the clear and sound advice he needs. M. G. S.

## MARCONI'S AT WAR

**M**AGNETRONS were being produced at the rate of nearly 2,000 a month by Marconi's at the end of hostilities, and a total of forty tons of quartz was used in the company's quartz laboratories during the war. These are but two examples from the statistics given *inter alia* in George Godwin's profusely illustrated 127-page book "Marconi—a War Record," which is published by Chatto and Windus, 40-42, William IV Street, London, W.C.2, priced 10s 6d.

## • ALL-POWER • Regulated H.T. Supply Units

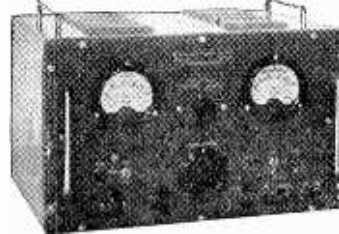

### STANDARD MODELS

A range of standard models is available, of various output voltages and current ratings. Illustrated is the Model 101-A, which provides an output voltage from 250 to 400 volts, at up to 250 mA, with a Stabilization Ratio greater than 100 and an Internal Resistance less than 1 ohm. This unit also provides unregulated A.C. outputs of 6.3 volts 3 amps. and 4 volts 5 amps.

### SPECIAL MODELS

Special Power Supply Units can be constructed to suit customer's individual requirements. High voltage supplies for Cathode Ray Tube operation, with outputs up to 10 kV, can readily be constructed.

### ELECTRONIC INSTRUMENTS

In addition to our steadily increasing range of very high quality test equipment, we are also able to produce specialised equipment to customers' specifications.

### TRANSFORMERS

We are specialists in the manufacture of very high quality Power and Audio Transformers and Chokes of all types, and our production system has been specially designed to cater for small quantity orders which are urgently required for Research and Development purposes.



ONE OF OUR MANY ALTERNATIVE  
TYPES OF MOUNTING

**ALL-POWER TRANSFORMERS LTD.**

8a, Gladstone Rd., Wimbledon, S.W.19.

Telephone: L1Berty 3303.

# WIDE RANGE TONE CONTROL

## Circuit Suitable for Correction at Low Volume Levels

By J. M. HILL, B.Sc.

IF an amplifier is being designed solely for quality reproduction at fairly high volume level, tone control circuits are only required for relatively small corrections of recording or speaker deficiencies. In such a case it is not necessary to have a tone control circuit with a very wide range, and the many circuits already published are fully satisfactory for this purpose.

Many people, on the other hand, require an amplifier not only for the purpose of high-level working but also for low-volume reproduction, in which case the requirements of the tone control circuits are totally different. At low volume levels the ear is less sensitive to the extreme bass and top, and consequently, for good reproduction and pleasant tone, it is necessary to have a very great lift of the extreme bass, and also a fairly large lift of the extreme top. It is also an advantage if the tone control circuit has a position that is truly linear and not just half-way between top cut and top lift.

straight into a push-pull output circuit. Three valves are shown, one being a double triode. The circuit gives a large overall gain, the input from a pick-up being sufficient to fully load an output stage of PX25's or similar valves.

The signal is amplified in the first valve after passing through the volume control and from the anode it is taken to three potentiometer circuits. The first two chains are connected to the ends of the "top" control potentiometer. The value of this potentiometer is high enough effectively to isolate the networks connected at the two ends, and consequently movement of this control from left to right gives a variation from a truly linear signal to a large lift of the higher register. An attenuation ratio of 5:1 is incorporated in the linear position to give constant volume over the whole range.

The "bass" control is incorporated in a normal bass lift circuit, the bass voltage developed

lift for low volume levels, or at any volume for those people who like it, it has been found necessary to amplify this bass signal in a separate bass amplifier valve  $V_2$ .

The two signals, the top and middle frequencies from the top control potentiometer and the

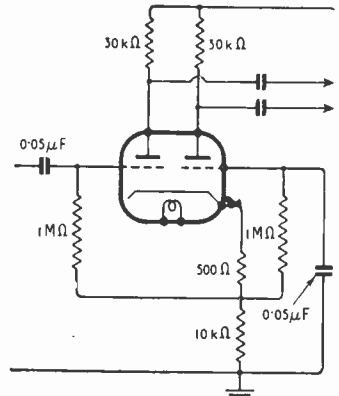

Fig. 2. Basic cathode-coupled paraphase amplifier.

amplified bass signal from the anode of  $V_2$  are mixed together in the correct phase in the last valve, which also acts as a paraphase amplifier. The signals at the anodes are equal in amplitude and opposite in phase, each being the sum of the top and bass frequencies fed into the two grids.

### Cathode-Coupled Paraphase

This last stage can be considered as being a modified form of the cathode-coupled paraphase amplifier. In this type of amplifier a current change in the first half of the valve causes a change in the common cathode voltage which produces an approximately equal and opposite change of current in the second half of the valve.

In the present circuit the two tone-controlled inputs are fed into the grids of the phase splitter simultaneously. The reason for mixing in this manner is that the bass signal has been reversed in phase in passing through  $V_2$  with

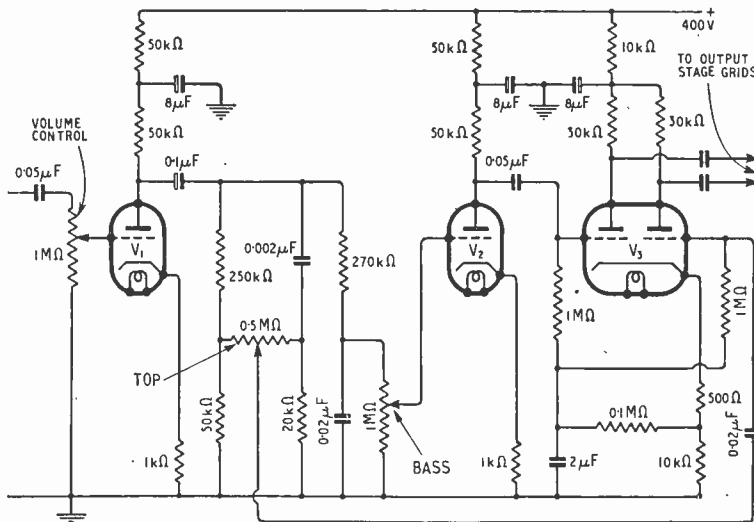

Fig. 1. General arrangement of wide range tone control circuit.

These requirements have all been met in the circuit shown in Fig. 1 which is designed to work

across the condenser being tapped off on the "bass" control potentiometer. To get sufficient bass



respect to the signal being passed through the top control circuit. By feeding these signals into the opposite grids of the phase splitter the two signals are brought into phase at the anodes. A further advantage of this method of mixing is that there is no attenuation, as there is in the more usual resistance network method.

In the phase splitter valve the bottom of grids have been decoupled to earth to prevent any signal being fed up from the cathode to the grids, as this would cause a bad imbalance of the signals at the anodes.

The controls, as outlined above, give the following possibilities: (1) linear position; (2) top lift, bass cut; (3) very large bass lift. For completeness a top cut circuit can be included, although it is very unlikely that it will ever be required in view of the enormous bass lift available. The modification to the "top" circuit is indicated in Fig. 3. This circuit is, however, not fully satisfactory, as at the middle position the output is not truly linear, but is effectively a half-way point between top cut and top lift (bass cut). This middle point will, unless values are very carefully chosen give either middle hump or middle cut.

To get over this difficulty a centre-tapped potentiometer is

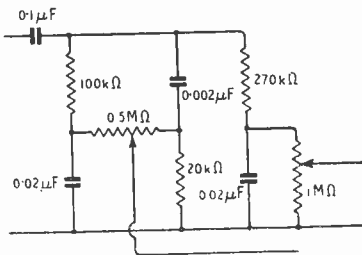

Fig. 3. "Top" control circuit modified to include top cut.

required. If this is not readily available an ordinary potentiometer can easily be tapped at the

centre point by drilling a small hole in the insulated base of the potentiometer and screwing down a small washer to make contact

with the outside of the track not used by the slider. A potential-divider network is connected to this centre tap as indicated in Fig. 4. If the resistance of the two arms of this potential-divider is high compared to the resistances

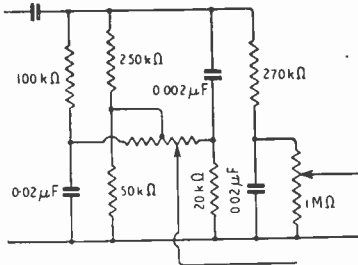

Fig. 4. Use of centre-tapped potentiometer circuit to preserve linearity of middle frequencies when using modified "top" control.

of the networks attached to it, the response at the centre point should be linear with no possibility of middle cut or middle hump.

A suitable valve for use in the first two stages ( $V_1$  and  $V_2$ ) in Fig. 1 would be the Mullard EBC33 (alternatives DL63 or 6J7, triode connected). For  $V_3$  a 6N7 or two 6J5's would meet requirements.

### MANUFACTURERS' LITERATURE

VALVES suitable for low-power transmitters are described in a leaflet, "Transmitting Valves for Amateur Communications," obtainable from the Publications Dept., Mullard Wireless Service Co., Century House, Shaftesbury Avenue, London, W.C.2. Dimensions, base connections and typical operating conditions are given.

Details of the "Sphere" signal generator, Type 505, are given in an illustrated leaflet issued by Sphere Radio, Heath Lane, West Bromwich.

Technical details and an N.P.L. report on the performance of "Instanta" relays are included in List A.C.R. issued by Instanta Electric, 48, Old Church Street, London, S.W.3.

The current issue of "The Albatram"—news bulletin of A. J. Balcombe, 52-58, Tabernacle Street, London, E.C.2—includes details of the new Model 473 de luxe table model and a list of revised prices of Alba sets.

Provisional specification and operational details of the Cossor marine navigational radar equipment are given in a brochure issued by A. C. Cossor, Ltd., Highbury, London, N.5.

## NEW ELECTRONIC STIMULATOR

In addition to the many Hearing Aids and the Radio Set for the Deaf, MULTITONE ELECTRIC COMPANY LTD. now presents

### THE RITCHIE-SNEATH STIMULATOR

an electronically controlled apparatus for the electrodiagnosis and treatment of nerve and muscle injury. The types of current available are: D.C. 0-10, 0-50 m.a. Sinusoidal A.C., 50 c.p.s. and square-shaped pulses of 100 to 0.01 millisecond length, interrupted at 3 variable rates.

The circuit of the square-shaped pulses consists of a modified form of multivibrator circuit, utilising a double-diode-triode and a triode-hexode, capable of giving the high ratio of 100,000:1 between interval and pulse. This multivibrator controls two power pentodes in parallel, which constitute a thermionic switch with an impedance of only 150 ohms between the adjustable D.C. supply, and the electrodes. A separately rectified H.T. supply is utilised for the power valve screens and for the multivibrator.

The various modalities of current are controlled by a large common dial in such a way that their actual intensities at any time can be read off from a scale; and this facility, usually available for D.C. only, is here applicable to them all.

The apparatus is portable, weighing approximately 20 lbs., and is only 9" x 9" x 8" in size. It is beautifully finished in white, or black with white fascia.

For further information, please write to

## MULTITONE

ELECTRIC COMPANY LIMITED

223/7 St. John Street, Clerkenwell, London, E.C.1.

Telephone: Clerkenwell 8022

# LOUDSPEAKER TRANSIENTS

## Residual Vibrations and Their Effect on Quality

IT has long been realized that response curves taken under steady-state conditions, valuable as they are in revealing the grosser resonances of inferior loudspeakers, do not give a complete picture of the quality of reproduction to be expected from the better grades of instrument. Listening tests often reveal distinct differences in tonal coloration from loudspeakers with similar and substantially flat response curves.

Curves taken with the usual automatic measuring gear, in which the input frequency is made to traverse slowly the full range of audio frequencies, take no account of the irregular changes of amplitude and frequency which are characteristic of all programme material and upon which the damping or lack

In practice it is an aggregate of vibrating elements each with its own frequency response and damping factor; the art of the loudspeaker designer lies in blending these elements to give the desired overall response. When the input to the loudspeaker is cut off, some of these elements may continue to vibrate, giving an effect analogous to room reverberation. This spurious reverberation may be pleasant or unpleasant, depending on the distribution and magnitude of the natural vibrations and the extent to which interference beats are produced. The ear receives a strong impression of "reverberation" when the residual vibrations have fallen 20db or more below the steady state level.

A technique for measuring the rate of decay of vibration at all

some interesting results have been obtained.

The loudspeaker under test was supplied with a variable test tone through a rotary interrupter giving make and break periods of about 1/20th sec. duration. The acoustic output from the loudspeaker was picked up by a microphone and applied to an oscilloscope, the horizontal time base of which was synchronized with the interrupter. The display gave a stationary picture of the sound decay envelope at any frequency, and the amplitude at any time interval after cessation of the driving frequency could be measured by moving a vertical slit mask across the face of the tube and observing the mean height of the trace where it crossed the slit. Visual estimation was necessary as, at frequencies other than those which were a multiple of the interruption frequency, a cyclical variation of amplitude resulted from variation in the instantaneous amplitude of the driving tone at the moment of interruption. A permanent record of the delayed response was obtained by manually adjusting the gain control of the microphone amplifier to keep the output constant; the pen recorder was arranged to follow the movement of the gain control.

Figs. 1 (a) and (b) are typical of the results obtained. Both are response curves of experimental 11-in corrugated cone loudspeakers with duode-type voice coils, and both have substantially flat steady-state responses (the lower limit of 300c/s was set by the limitations of the lagged sound chamber in which the tests were made). The aural impressions were, however, quite different and were related to the delayed curves rather than to the steady-state response.

It is interesting to note that in Fig. 1 (a) the acoustic output has actually risen with time at several points, suggesting the transfer of energy from one vibrating element to another during the decay period. During the course of

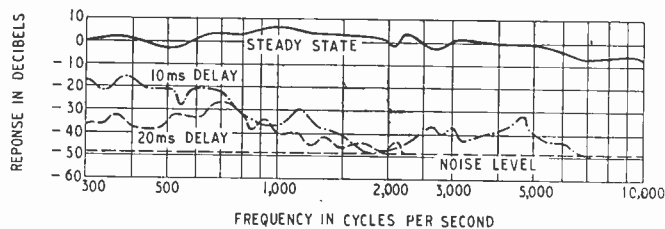

(a)

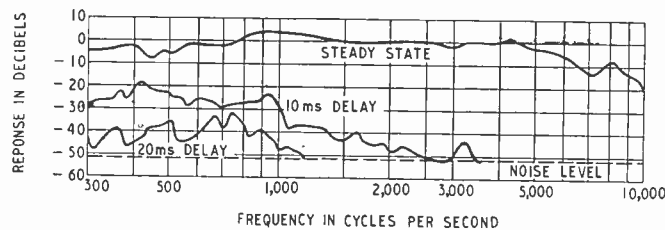

(b)

Fig. 1. Response curves of two 11-inch experimental loudspeakers with duode-type voice coils. The delay curves were taken at 10- and 20-millisecond intervals after cessation of the driving tone. Aural impressions: (a) Extended high-frequency response. Speech reproduction good, but on music the high-frequency response found a little irritating after long periods of listening. (b) Similar to (a), but high-frequency range relatively inoffensive.

of damping of the diaphragm may have a profound effect.

The ideal loudspeaker diaphragm should be a homogeneous piston moving as a whole under the influence of the driving force.

parts of the frequency scale has been developed by the Research Department of the B.B.C.\* and

\* "Loudspeaker Transient Response" by D. E. L. Shorter, *The B.B.C. Quarterly*, Oct. 1946.

**Loudspeaker Transients—**

measurements a ripple suggesting a beat effect was often observed, a signal frequency of the order of kilocycles per second being generally associated with a ripple frequency of a few hundred cycles per second. In each case the quality exhibited a "roughness" normally associated with intermodulation, though it was known that the loudspeakers were free from the amplitude distortion which is usually the cause.

Effects of this kind are apt to

be overlooked in the usual methods of testing for transients, which involve analysis of the oscillograms resulting from the application of a single square-fronted impulse to the loudspeaker. There can be no doubt that the method used by the B.B.C. is capable of greatly extending our knowledge of loudspeaker performance, particularly in the "tail" of the decay curve where high-frequency components of small amplitude may have an important aural effect.

## NEW COMMUNICATION RECEIVER

### Example of Post-war Naval Equipment

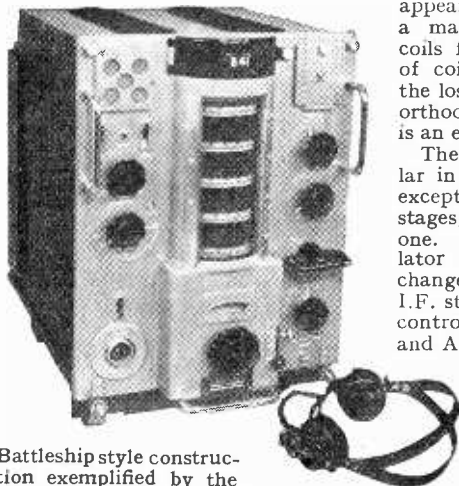

Battleship style construction exemplified by the Murphy-made Naval communications receiver, Type B41.

AFTER two years of development work carried out in conjunction with the Admiralty Signal Establishment, Murphy Radio has begun production of a new Navy communication receiver. Designated the B40/B41, this equipment is destined for the Admiralty and, of course, will not be available to the public, but its design and performance are such that a brief description may be of interest.

There are actually two separate receivers involved, one the B40, with a frequency coverage of 640 kc/s to 30.6 Mc/s, and the other, the B41, having a range of 14.7 kc/s to 720 kc/s.

Both sets have the same external

appearance and each is fitted with a massive coil turret, containing coils for five bands. This method of coil changing avoids many of the losses inseparable from the more orthodox switching systems, but it is an expensive form of construction.

The circuit arrangement is similar in both the B40 and the B41, except that the former has two R.F. stages, whereas the latter has but one. A mixer and separate oscillator comprise the frequency changer, which is followed by three I.F. stages, two of which are A.V.C. controlled, then comes the detector and A.V.C. double diode, a B.F.O., a noise limiter, an A.F. amplifier and, finally, an output pentode; twelve valves in all in the B40 and one less in the B41. In addition there is an H.T. rectifier and a neon voltage stabilizer.

Three degrees of I.F. selectivity are provided, giving band widths of 8 kc/s, 3 kc/s and 200 c/s respectively. The last mentioned is obtained with the aid of an audio filter in place of the traditional I.F. crystal filter.

In order to maintain a constant check on the frequency calibration the B.F.O. stage can be switched to become a crystal oscillator giving calibration points on its harmonics throughout the waverange.

As the illustration shows the sets are assembled in massive cases of unusual but functional design. In the centre, at convenient eye level, are the vertically disposed drum scales for the five wavebands and the tuning control. Grouped on either side are the subsidiary controls and switches.

*Now available*  
**NEW**  
**IMPROVED**  
**1946 MODEL**

Gramophone Cabinet Amplifier  
TP.633E (RC)

(As illustrated) 30-watts output, incorporating Garrard Automatic Record Changer, is typical of the Trix range. Other models with outputs from 15-30 watts, with or without Automatic Record Changer, are available. Also AC/DC types. Substantial cabinets, in light natural oak finish, afford easy access to valves. All controls are conveniently grouped in a recessed panel on the front.

Full details of this and other models sent on request.



**TRIX**  
*Quality*  
**SOUND EQUIPMENT**

THE TRIX ELECTRICAL CO. LTD.

5 MAPLE PLACE, TOTTERHAM COURT ROAD, LONDON, W.1  
42, GERRARD STREET, MUSGRAVE, LONDON, W.1

# UNBIASED

By *FREE GRID*

## Silver Jubilee

**N**EXT year the B.B.C. will celebrate the silver jubilee of the beginning of regular broadcasts—November 14th is the exact date—and although it may seem a bit early to start talking about it, it is none too soon for the Corporation to be-



B.C. or  
B.B.C. ?

gin preparing plans to celebrate this historic anniversary.

One small gesture that the Board of Governors might make would be to endeavour to prevail upon the P.M.G. to allow a year's free licence to all of those who produced proof that they were licence holders, or at any rate listeners, on November 14th, 1922, when 2LO started its regular transmissions, prosaically enough by broadcasting general election results.

It is not outside the bounds of possibility that 2LO's successor could be doing the same thing on November 14th, 1947, even though the present Parliament will then have served not quite half its allotted span, for it must not be forgotten that although its predecessor elected in November, 1922, also made its debut with a very comfortable majority for the leading party and a five-year mandate, such are the vicissitudes of politics that thirteen months later saw us all queuing up once more with hope in our hearts to back our fancy on the political totalisator.

But all this is a side issue. The only real way to celebrate the event would be to bring home to people what enormous strides have been made in 25 years and what truly ghastly quality we pioneers were pleased to call marvellous. Now there is only one way to do that and that is for a programme on the celebration day—or week—to be pumped out on one of the medium wavelengths with the exact

"quality" which we heard from our loudspeakers in 1922. We could then, by making a swift change to another wavelength, receive the same programme with present-day quality and note the difference, which certainly wouldn't be very great in the case of those who are content to tune their sets half-way up one of the sidebands.

To achieve realism, by far the best plan would be to erect a replica of the old 2LO transmitter on the roof of a building in central London and receive its efforts on a 1922 set somewhere in the Home Counties, there being a modern mike, connected directly to Broadcasting House, standing in the room in which was the ancient receiver. Listeners could then compare three things, namely, the distortion due to the 1922 transmitter alone (by tuning in directly to it), the additional distortion caused by the 1922 receiver and, of course, the all-1947 version of distortion.

As I have already pointed out, many people might not notice much difference.

## Wireless and Weather

**I** SEE by a newspaper cutting, which a kindly correspondent has sent me, that the hoary old superstition that wireless waves are responsible for unseasonable weather is still going strong. I do not think, however, that it is sufficiently realized how old this particular superstition is.

The year 1912, as I well recollect, had an even wetter summer than this year and as wireless had been thrust rather prominently before the public eye by the *Titanic* disaster in April, it was, of course, blamed for the mighty deluge of waters which engulfed the land all through the summer and turned Norwich, in particular, into a miniature Venice. Even earlier, very severe censure was visited on wireless in 1902 when there was a very wet spring following the first wireless bridging of the Atlantic in the previous December, and when the coronation of King Edward VII had to be dramatically postponed from June to August it was felt by some good people that the King's sudden illness was somehow or other bound up with the inclement weather.

In 1898, when the establishment of direct contact between Queen Victoria in Osborne House and the Prince of Wales on the Royal yacht as it doubled St. Catherine's Point brought immense publicity to wireless, the weather remained perfectly seasonable, but were the superstitious pseudo-scientists effectively silenced? Not a bit of it, for they lost no time in pointing out that statistics showed that at this particular time of the year the weather was normally abnormal and they blamed wireless for the fact that in this instance it was abnormally normal.

I have been doing a little bit of historical research work concerning this matter into periods somewhat earlier than the limit of my personal recollection and I find that not only wireless but every earlier development of electrical sciences has been held responsible for unseasonable weather, whether in the form of drought or deluge. In the 'eighties the development of electric lighting was supposed to be responsible for the series of droughts, while as far back as 1830 the experimental work of Faraday was held by many to be the cause of the series of mighty storms which ushered in the reign of William IV.

I have not yet gone as far back as Queen Elizabeth's reign, but I have little doubt that the publication of Dr. Gilbert's famous work, "De Magnete," and the way in

"He electrified  
Good Queen  
Bess."



which, in more senses than one, he electrified Good Queen Bess by rubbing a stick of sealing wax on her silk stockings, were held jointly responsible for the great gale which finished off the Spanish Armada as its shattered remnants tried to make their getaway westward through the Pentland Firth.

# RANDOM RADIATIONS

By "DIALLIST"

## Flourescent Lighting

SEVERAL readers have criticized my method of making a 40-watt fluorescent tube interchangeable with an ordinary glow-lamp by the use of a batten lampholder on the ceiling and a bayonet adaptor at the end of the flex. They point out that it is important to have the choke in the phase lead, since otherwise the tube won't be protected if certain kinds of trouble occur. Yes, I know that one; though, curiously enough, some makers don't mention it in their "books of the words." What I have done is to find out with the help of an Avo which position of the bayonet adaptor is the correct one. Then small hollows were made with the point of a drill in holder and adaptor and filled with white paint to act as indicators. If you do that you can't connect wrongly unless you are very careless.

Some correspondents also take up the point I made about the "strobing" of the moving parts of workshop machinery owing to the 50-cycle flicker of these tubes. If you remember, I warned amateur workshop fans of this danger. Readers mention that in large works the trouble is avoided either by using banks of fluorescent tubes in different phases of a three-phase supply, or by providing strong glow-lamp illumination for individual machines. I know that one too! But I was writing about the home workshop, where a single-phase supply is usually all that is available and where a bank of tubes would anyhow be too much of a good thing. Amateurs can, of course, use a fluorescent tube for overall lighting and fit the separate glow lamps for the lathe, the drilling machine and so on; but the average home workshop is hardly big enough to justify so elaborate a lighting scheme.

□ □ □

## Still Going Strong

SOME time ago I ventured to suggest to our wireless manufacturers that the post-war market for radio receivers might be a good deal less vast than the slap-happy optimists amongst them fondly imagined. My point was that many of the existing sets required only a thorough overhaul to make them as serviceable as ever and that the owners of such sets were not likely to buy new ones unless these contained very real improvements. There are, of course, large numbers

of old sets which either are beyond repair altogether or would cost more than they are worth to set right. Many, too, are inferior performers by to-day's standards even if they are in perfect working order. The present demand is largely for replacements for receivers of these kinds. There is also a big demand for sets by those who have never previously owned one. But manufacturers will have to decide to offer new sets of outstanding design and performance if they want to capture the largest potential home market of all, the replacement of receivers seven or eight years old which are still giving a good account of themselves. This point was brought home strongly to me during a recent visit to some friends who own a 1937 auto-change radiogram. It has just had an overhaul, in the course of which it was lined up and fitted with new valves where these were needed. The volume control was a bit scratchy, but treatment of the track with carbon tetrachloride put that right. Otherwise there was nothing to be done. The owner would buy a new instrument if he could find anything obviously better than the one he has. So far he has not succeeded in so doing.

□ □ □

## "Security"

THE letter from Robert A. Gordon in last month's issue raised some very interesting points about security and its application to some wartime developments not only in radar, but also in telecommunications. There are some departments of radar, for example, which I believe still to be on the "hush-hush" list. For that reason I have never ventured even to hint at their existence, and other writers in this country have been similarly reticent. Many of us have kept tight under our hats wonderful stories that we have been yearning to tell—only to see the gaff partly or completely blown by our opposite numbers on the other side of the Atlantic. There are few things more annoying than to find a purely British invention still kept dark here, but proclaimed by American writers as a triumph of their countrymen's genius. It has happened again and again and one fears that it will go on happening until the security position is cleared up. I don't for one moment believe that reputable American writers intentionally belittle our achievements

## ONE LOUDSPEAKER —360° COVERAGE

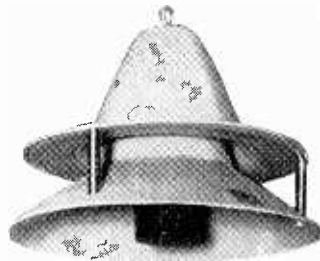

This new type, called the CIRCORN, has horn-speaker efficiency together with completely uniform distribution throughout 360 deg.

Typical advantages:—ONE centrally placed will cover the whole of a medium-sized area; used on a moving vehicle results are equal approaching, passing or receding, thus ideal for street processions, elections, etc.

List price—Horn only £7 0 0.  
Complete £14 5 0.



M.5  
Moving Coil  
MICROPHONE

No polarising current, adequate frequency response, low impedance, high output due to a very efficient magnet and careful design.  
List price £5 15 0.



L.S.7 HORN LOUDSPEAKER  
Maximum sensitivity and volume. Impedance 10 ohms; handles 12 watts 170-10,000 c.p.s.  
40 in. horn. List price £13 10 0.

**F.I. for P.A.**  
**FILM INDUSTRIES LTD.**  
60, PADDINGTON ST., W.1  
Telephone: WELbeck 2385

### Random Radiations—

in order to emphasise the importance of those of their own folk. Having worked closely with American technical people in two wars, my experience is that they are characterized much more often by modesty than by the lack of it attributed to them by tradition. But what can they think, or write, or do about it if we are stupid enough to enforce silence concerning our part in discoveries freely disclosed by their naval and military authorities?

□ □ □

### Overworked Symbols and Terms

GOOD service has been done by "Cathode Ray" in calling attention to the overworking of  $\mu$ . It is by no means the only symbol that would have just cause of complaint to the Amalgamated Society of Symbols, if there were such a trade union—and it's rather a pity that there can't be. There are certain technical terms, too, which mean far too many different things in different contexts. Imagine the poor beginner who, having mastered Ohm's Law (or has he?) thinks that he now knows all about resistance. A few pages later in his reading he encounters high-frequency resistance and, after digesting that, he comes presently to anode resistance. Faint but pursuing, he carries on only to meet dynamic resistance in the chapter devoted to tuned circuits. Four different kinds of resistance, all measured in ohms, but all signifying entirely different things. I think we might lighten his lot and lessen his natural confusion of thought if we adopted another term in at any rate one instance. A parallel tuned circuit is a rejector, and as in these days all electrical -tors have -ivity or -ity to denote their special property and -ance to denote the measurable quantity of it inherent in them, why shouldn't we speak of rejectivity and rejectance? I think that rejectance is a much more expressive term in this instance than dynamic resistance. And we might equally well use acceptance for the series tuned circuit as the counterpart of conductance in a D.C. circuit.

□ □ □

### Frequencies and Wavelengths

THE gifted editor of the French wireless magazine *Toute la Radio* has recently proposed that we should standardize the classification of wavelengths and frequencies which was first put forward in 1937 by Dr. Smith Rose. At present long, medium, short and ultra-short waves and low, medium, high and

very high frequencies are terms that one often used with no generally accepted meanings. As Monsieur Aisberg said when he spent a day with me last summer, "If you ask ten radio experts what these terms mean, you won't get fewer than six different answers and you may get as many as ten." The Smith Rose system is metric and as we measure electro-magnetic waves in metres or fractions of metres, it seems to be founded on sound common sense. Here it is.

Class	Wavelengths (m.)	Frequencies (kc/s)
1. Kilometric waves ...	Above 1,000	Below $3 \times 10^3$
2. Hectometric " ...	100 — 1,000	$3 \times 10^3$ — $3 \times 10^4$
3. Decametric " ...	10 — 100	$3 \times 10^4$ — $3 \times 10^5$
4. Metric " ...	1 — 10	$3 \times 10^5$ — $3 \times 10^6$
5. Decimetric " ...	0.1 — 1	$3 \times 10^6$ — $3 \times 10^7$
6. Centimetric " ...	0.01 — 0.1	$3 \times 10^7$ — $3 \times 10^8$
7. Millimetric " ...	0.001 — 0.01	$3 \times 10^8$ — $3 \times 10^9$

It seems an exceedingly good classification, for waves of similar general characteristics fall into the same category. For example, in Class 1 we have the wavelengths on which fading does not normally occur; in Class 2 those reflected by the E layer; in Class 3 those reflected by the  $F_1$  and  $F_2$  layers—and so on. People who habitually think in frequencies may frown on any classification based on wavelengths; but, though the names suggest wavelengths, this one is based equally on frequencies. Anyway, in these days of very high frequencies or very short waves, wavelengths have come back into the picture, for you must use them in designing aeriels, reflectors, waveguides and so on. Most V.H.F. workers seem to think and talk almost exclusively in terms of wavelengths. Last but not least, both wavelength and frequency scales are logarithmic.

□ . □ □

### The French Have a Word for It—or Have They?

IF any young limb of a schoolboy (and most self-respecting schoolboys are young limbs, says I, having been one) wishes to confound a conceited young modern language master (and most young modern language masters are conceited, says I, having been one in the days of my youth), let him raise his hand and ask, with the expression of bland innocence assumable only by young limbs, "Please, Sir, what is the French for wobbulation?" Should the retort be a stinging "inpot," on the grounds that there is not and could not be any such English word

as wobbulation, Injured Innocence may stave off both wrath and imposition by explaining that wobbulation is a perfectly good technical term in English and that its equivalent in French is (as the writers of thrillers would put it) none other than *la wobbulation*. Equally good French are *le spot* (for the spot on the C.R.T. screen), *le strobing*, *le radar* (or *la radiolocation*) and *le broadcasting*. One of the most curious of French technical terms is *un self*, signifying what, in these days of enlightenment we would call an inductor. Originally *un self* was *une bobine de self-inductance*—a self-inductance coil. And there are many other French technical

terms in electricity and wireless which carry similar stamps of their British origin.

□ □ □

### Returning the Compliment

Off-hand, I can't think of many instances in which we have returned the compliment by adopting French words or proper names in our technical jargon. Ampere and Curie are examples that come to mind of basic units of measurement named after eminent French scientists. But perhaps the outstanding case of Anglo-French borrowing is our use of "high-tension" (high-tension voltage, high-tension current, high-tension battery, and so on) for conditions appertaining to the anode circuits of radio valves. The French use the word *tension* to signify an E.M.F. or P.D. between two points in a circuit. In so doing they are far more correct than we, for a *tension* signifies not so much a *push* (out-of-date positive current) as a *pull* (modern conception of an electron current). I, for one, would be happy to see the wider and more general adoption of *tension* in electrical text books to replace *pressure*.

□ □ □

### What is Wobbulation?

Possibly you are doubtful about the authenticity of wobbulation as a respectable technical term. I can assure you that it is accepted in the highest radar circles as the means whereby a pulse transmitter is caused to operate with a varying instead of a fixed recurrence frequency. Your radar equipment works normally with a recurrence frequency of, let us say, 1,000 per second; switch on the wobbulator

(the wob for short) and the recurrence frequency is no longer steady. It varies, perhaps, between 1,200 per second at one moment to 800 per second at another. And the usefulness of that? Well, it's a very handy defence against some kinds of interference. Two radar sets, if provided with wobs, can operate on the same wavelength and yet experience no mutual interference though quite close to one another. The wobulator also gave the answer to one rather neat little trick that was tried at times by Jerry bombers. This trick was a development of an earlier form of what we called "spoofing" which did not meet with marked success. For that the German bomber was fitted with a responder, rather on the lines of I.F.F., which sent out a pulse on being triggered off by the radar signal. A small amount of delay was used and the result was that two breaks or "blips" appeared on the radar trace, one genuine and one spoof. The idea was that gunners might be induced to engage the second break and to put their shells miles astern of the real target. It did not work very well, partly because G.L. operators instinctively adopted the leading break as that of the most desirable target, and partly because if you had two breaks, one following fairly close behind the other, you could easily test the genuineness of No. 2 by reducing temporarily the transmitter power output. Do that, and the genuine break is at once reduced in amplitude whilst the size of the spoof is unaffected. Jerry's next clever trick was to produce a spoof break in front of that due to the target. This was done by introducing so much delay into the responder that the spoof break due to one pulse occurred only a little before the genuine break due to the next pulse. So long as the recurrence frequency of the radar set is steady the spoof break will then glide over the C.R.T. screen some distance ahead of the real one. But you can't do that kind of thing unless the recurrence frequency of the radar set is nice and steady. Directly the wobulator was switched on the spoof break ceased to have any chance of doing its stuff.



## *Harping on the* **SAME STRING**

Composers have found happy inspiration in variations on a given theme. Manufacturers, less happy than composers, must harp on the same string. Necessary though irksome controls and shortages of materials and skilled labour are our theme. For the moment there are no variations.

We therefore tell you of our difficulties so that you will have patience and understanding. For the future two things are certain. First, you may expect a slow but steady increase in deliveries of Bulgin Components. Second, you will find that every Bulgin product conforms to the precision standards we have maintained for a quarter of a century.

# **BULGIN**

(REGD. TRADE MARK)

*Famous Since Broadcasting Began*

**A. F. BULGIN & CO., LTD.**

**BYE PASS ROAD - BARKING - ESSEX**

Rippleway 3474 (5 lines)

### Standardizing Aircraft Radio

THE new design of aircraft rack-ing referred to in the article on aviation radio equipment in our November issue arose from the work of a standardizing panel of the Radio Communication and Electronic Engineering Association.

# RECENT INVENTIONS

## A Selection of the More Interesting Radio Developments

### SIGNALLING BY PULSES

**I**N a known method of signalling, successive pairs of pulses, in a normally evenly spaced sequence, are moved closer together as the modulating voltage rises, and are shifted further apart as the modulating voltage falls.

On the present invention, this effect is secured by shunting a pair of control valves across a high reactance in series with the H.T. supply to the main oscillation generator. The control valves are coupled in push-pull to a source of constant frequency, and are so biased that current is always passing through one or other of them except for a short period, near the zero value of the constant-frequency cycle. At the instant during which both valves are cut-off, the reactance triggers the main oscillator, so that a short pulse is repeated at regular intervals.

The modulating signal is also superposed, in push-pull, on the same pair of valves. As the signal-voltage rises, it acts to increase the bias on one valve and to decrease that on the other, thereby diminishing the time-interval between successive pulses. A falling signal voltage has the reverse effect.

*Marconi's Wireless Telegraph Co., Ltd. (Assignees of C. W. Hansell). Convention date (U.S.A.), November 29th, 1940. No. 574674.*

### TRANSMIT-RECEIVE SWITCH

**E**XPLORING pulses are radiated directly from the open flared end of a wave guide which also serves to receive the returning echo signals.

Pulses from a magnetron generator are fed through a coaxial line, which enters the far end of the wave guide at right angles to the long side of its rectangular cross-section. The receiving circuits are branched off at a point nearer the flared end of the guide, through a slot formed in the short transverse side of the guide, and through a separate internal half-wave section.

During transmission, the receiving circuits are short-circuited by a spark-discharge, which prevents the high-level energy from entering them. At the end of each outgoing pulse, the altered impedance of the magnetron diverts the incoming echo signal wholly into the receiving branch.

*Western Electric Co., Inc. Convention date (U.S.A.) January 30th, 1943. No. 575432.*

### ELECTRET FREQUENCY CHANGER

**A**N electret is the electrostatic equivalent of a permanent magnet. It is prepared by subjecting a wax composition to an intense electric field under such conditions that the mole-

cules are polarized and retain a static charge. A saturated electret responds to an alternating voltage in much the same way as does the winding of a saturated magnetic core. Its behaviour differs from that of an ordinary rectifier, because non-linear reactance is substituted for non-linear resistance, so that heat-losses are reduced.

According to the invention, an electret is used as a frequency changer, to generate harmonics, and as a modulator. In one application, the primary frequency is fed to an electret suspended along the axis of a wave guide section tuned to the desired harmonic frequency. For modulation, the carrier wave is fed along a wave guide and through a tuned section, which contains the electret together with means for coupling it to the signal frequency.

*Standard Telephones and Cables, Ltd. (assignees of G. C. Southworth). Convention date (U.S.A.), March 25th, 1941. No. 574837.*

### PORTABLE SETS

**A** RECEIVER is built to resemble a small attaché case, and the controls are arranged so that they can be operated by the hand that carries the set.

The tuning control is a knurled disc which fits into a recess made under one end of the carrying handle almost flush with the top of the case, the reaction or volume control being similarly placed under the opposite end of the handle. Each disc projects sufficiently to allow of easy manipulation by the thumb or finger, but is otherwise protected from accidental damage. The tuning disc drives a variable condenser through a cord, which runs over pulleys mounted inside the handle, and moves a pointer over a calibrated scale, set just inside the upper surface of the handle.

*Philco Radio and Television Corp. (assignees of R. J. Whipple). Convention date (U.S.A.), February 11th, 1943. No. 575493.*

### TONE CONTROL IN RECEPTION

**T**HE audible frequencies present in ordinary broadcast transmission usually cover a band of from 50 to 8,000 c/s, which is insufficient to reproduce the full timbre, say, of an orchestral performance.

According to the invention, certain selected harmonics are generated in the receiver and are added to the transmitted signals in order to restore some at least of the missing high-frequency components.

A part of the output from the first A.F. amplifier is diverted to a circuit which is shunted across the ordinary inter-valve coupling to the next A.F. stage. This branched circuit includes a filter which passes the higher notes

to a pair of diodes, arranged as a square-law frequency-doubler. The resulting second harmonics are then fed, in parallel with the original signal frequencies, on to the grid of the second A.F. amplifier. A variable resistance across the two diodes serves to regulate the amplitude of the added harmonics.

*Ferranti, Ltd., and M. K. Taylor. Application date, December 2nd, 1943. No. 573168.*

### WAVE GUIDES

**A** CONTRACTION in the cross-section of a wave guide acts as an inductance in shunt with the line, whilst a probe of insulating material is equivalent to a shunt capacity having a value depending upon its depth of penetration. By using a combination of both devices, the impedance of a wave guide can be adjusted to match, say, the impedance of a given input or output valve.

An apertured metal diaphragm is inserted into the guide to constrict the free flow of energy at one or more selected points. The associated probes, preferably made of quartz or silica, are set at fixed distances on either side of each diaphragm. They are mounted on a block, fixed to the outside wall of the guide, so that they can be screwed down to penetrate the interior space to the required depth.

*The British Thomson-Houston Co., Ltd.; L. W. Brown; and J. H. Nicoll. Application date March 30th, 1944. No. 575739.*

### GENERATING SHORT-WAVE PULSES

**A** MAGNETRON short-wave oscillator is operated with a photo-sensitive instead of a thermionic cathode, so that pulse-modulation can be effected by exposing the cathode to the action of intermittent light rays. This avoids the technical difficulties involved in switching the high-voltage anode circuit at the required speed. It also saves power since no electrons are emitted between successive pulses.

The cathode is cylindrical, and encloses a coaxial grid and anode, both of which are perforated so that they pass light freely. A spark-gap is arranged inside the hollow anode, and is fed through a storage condenser to produce intense discharges of extremely short duration. Under this form of excitation, the cathode emission is stated to reach an instantaneous level of several hundred amperes.

*The British Thomson-Houston Co., Ltd. (communicated by General Electric Co.), Application date, May 27th, 1943. No. 574844.*

The British abstracts published here are prepared with the permission of the Controller of H.M. Stationery Office, from specifications obtainable at the Patent Office, 25, Southampton Buildings, London, W.C.2, price 1/- each.





**ERIE**

*Electronic Component Products*

**RESISTORS • CERAMICONS • Hi-K CERAMICONS**

**SUPPRESSORS • POTENTIOMETERS**

**VITREOUS ENAMELLED WIRE-WOUND RESISTORS**

*Full details gladly sent on request*

**ERIE RESISTOR LIMITED**

**CARLISLE ROAD • THE HYDE • LONDON • N.W.9 • ENGLAND**  
 TELEPHONE: COLINDALE 3011-4      TELEGRAMS: RESISTOR, PHONE, LONDON      CABLES: RESISTOR, LONDON  
 FACTORIES: LONDON, ENGLAND      TORONTO, CANADA      ERIE      U.S.A.

## LABGEAR

### FOR MODERN RADIO SERVICE ELECTRONIC FAULT TRACER

A COMPLETE WORKSHOP...ALL IN ONE INSTRUMENT  
now enables your radio repair department to

GIVE || SPEEDIER SERVICE  
RELIABLE RESULTS

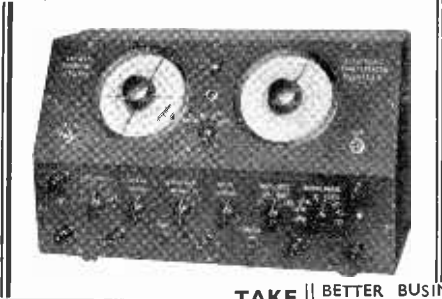

TAKE || BETTER BUSINESS  
PROLIFIC PROFITS

EMBRACES IN ONE UNIT THE FOLLOWING INSTRUMENTS

- Signal Generator ●
- Insulation Tester ●
- Capacity Bridge ●
- Voltage Indicator ●
- H.T. Power Supply ●
- Resistance Bridge ●
- Audio Oscillator ●
- L.T. Supply Source ●

PLUS

**SIGNAL TRACING**—the most modern method of FAULT FINDING from Aerial socket to Loudspeaker. All this for a cost of £34-10-0. (A price not greatly in excess of any individual instrument listed above).

In your own interest write now for list B.2001 W.W. to

'Grams : **LABGEAR** 'Phone :  
"Labgear, Cambridge" WILLOW PLACE, CAMBRIDGE 2494 (2 lines)

Clear, NATURAL  
tone explains why  
executives demand

## intercom

by



Staff  
need  
not  
move—

touch nothing  
to reply  
**INSTANTLY**

- NO TELEPHONES
- NO DELAYS

2-way loudspeaking conversations IMMEDIATELY between executives and any office or dept; Swift and simple Installation; 2 to 30 way systems to suit any Business Factory layout.

**ARDENTE INTERCOM HAS FEATURES COMBINED IN NO OTHER SYSTEM. Tradeterns from:—**

**ARDENTE ACOUSTIC LABORATORIES LTD.**

London Office: 309, OXFORD ST., W.1. Mayfair 1380  
Works: GUILDFORD, SURREY. Guildford 3278-9



# neosid...

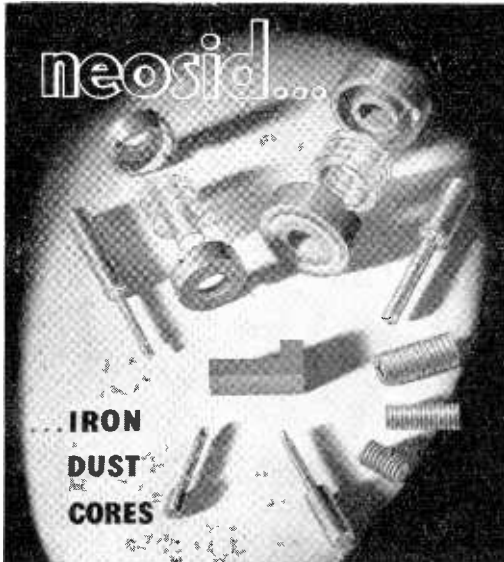

**IRON  
DUST  
CORES**

High performance, Strength, Stability. Close electrical and mechanical tolerances. Grades to suit various applications.

**neosid Limited**

23 & 25, Hyde Way,  
Welwyn Garden City, Herts.

Tel.: Welwyn Garden 925.

W.W.I

## Simon

SOUND SERVICE

### THE COMPLETE SERVICE FOR SOUND RECORDING AND REPRODUCTION

- ★ Mobile and Static Continuous Recording Outfits.
- ★ Recording Amplifiers.
- ★ Moving Coil and Crystal Microphones.
- ★ Sapphire Cutting and Reproducing Stylis.
- ★ Blank Recording Discs from 5" to 17" Single or Double sided.
- ★ Light-weight moving iron, permanent sapphire and "Lexington" moving coil pick-ups.
- ★ Label and Envelope Service.
- ★ A comprehensive range of accessories to meet every requirement of the sound recording engineer.
- ★★ And our latest development (of special interest to users of sapphire or delicate pick-ups)—The Simtrol.  
This is a controlled micro-movement easily fitted for use with any type of pick-up to eliminate the danger of damage to the record or pick-up. This is achieved by a vernier lowering action of the pick-up head to the record.

Write for comprehensive lists or call at  
Recorder House for demonstration.

**RECORDER HOUSE, 48/50 GEORGE ST.,  
PORTMAN SQUARE, LONDON, W.1.**

Telephone: WEL 2371/2 Telegrams: Simsale, Wesdo, London

Rate 6/- for 2 lines or less and 3/- for every additional line or part thereof, average lines 5-6 words. Box Numbers 2 words, plus 1/- Press Day: January 1947 issue, first post Friday December 6th. No responsibility accepted for errors.

**WARNING**

Readers are warned that Government surplus components which may be offered for sale through our columns carry no manufacturer's guarantee. Many of these components will have been designed for special purposes making them unsuitable for civilian use, or may have deteriorated as a result of the conditions under which they have been stored. We cannot undertake to deal with any complaints regarding any such components purchased.

**NEW RECEIVERS AND AMPLIFIERS**

**A** NEW development from Charles Amplifiers. A NEW conception in radio tuning units, our latest development, just released, is a radio tuning unit, which provides, at the touch of a switch, either a sensitive all-wave superhet, or a high fidelity local station T.R.F. receiver. Our well-known amplifier kits, embodying original circuits aimed at providing the highest standard of fidelity in the reproduction of radio and records are still available; the amplifiers are 3- and 7-watt models and incorporate the cathode follower output stage which reduces distortion to a negligible degree and gives amazing reproduction of transients; both also incorporate an original tone control network which is noise distorting and gives separate control of bass and treble. All components are available separately or in complete kits and include ready drilled chassis; blue prints including full size point to point wiring diagrams are 2/6 each or 5/- the set of 3; stamp for details and lists; post only.

**CHARLES AMPLIFIERS**, 14, Lapstone Gardens, Kenton, Middlesex. [6267]

**20** WATT amplifier, new KT66's, 6N7, out. trans.; £11-15, Rossdale, Sutton, Sny.

**C** COMMUNICATION receivers — "Dale" will have them as soon as trading conditions allow.—Remember—Dale Electronics, Ltd., 105, Bolsover St., W.1. Mus. 1023.

**N**EW aligned shet all-wave tuning heart by Teleradio, ready Nov. 1; coil pack only 32/6.—Full details and specification, 2d. stamp, Dept. W.W., 157, More St., N.18.

**A** MPLIFIERS, 6 watts push-pull output, complete with 10in speaker, for use on A.C. mains, good quality job, tone control, etc.; call and hear one or send for descriptive leaflet "W".

**CHARLES BRITAIN (RADIO) Ltd.**, 2, Wilson St., London, E.C.2. [6508]

**A** MPLIFIERS; new 1947 model Hi-Fi units, with triple tone controls, built to customer's specification.—Broadcast & Acoustic Equipment Co., Ltd., Broadcast House, Tombland, Norwich 26970. [6433]

**F**ERGUSON model 909 universal ac/dc 5-valve superhet, 100-250volts, walnut cabinet, new, 12gu, plus purchase tax £2/14/3.—West Central Radio Supplies, 259, Grays Inn Rd., London, W.C.1. Tel. Ter. 6777.

**14** watt amplifiers for mike or gramophone attention, low intermodulation distortion, 25gu; transformers (bakelite impregnation, special stallo); from £12/6; castings, turning, duraluminium cases and decks to customer's specification—R.R. Development Laboratories (consulting engineers), Barnard Rd., Bradford. [5801]

**Q**UALITY reception of local station combined with communications receiver sensitivity is offered by the Silver Dragon—the receiver which is different; full details of this remarkable instrument, which contains many new and novel features, may be obtained from the makers, 25d. stamp please.—The Moreton Cheyne Co., Ltd., Gaol Rd., Stafford. [6342]

**S**ILVER DRAGON receiver, a fine example of British ingenuity & engineering, precision built & of advanced design, for those who require high sensitivity plus high quality of reproduction.—For details send 2d. stamp to The Moreton Cheyne Co., Ltd., Gaol Rd., Stafford.

**B**RIERLEY "Ribbon" and "Armature" pick-ups. Please write your name and address in block letters and include 3d. for booklet containing illustrations, responsive curves, technical details, delivery and prices. These booklets explain aspects of pick-up design, developments, including the "floating element" design, leading to the use of 1/4 and 1/8 oz downward pressures; the importance of adequate and constant point pressure and its practical achievement; correct point shape; the relation of pick-up weight, point pressure and vertical motion, etc. etc.—J. H. Brerley Ltd., 46 Withern St., Liverpool. 2. [5701]

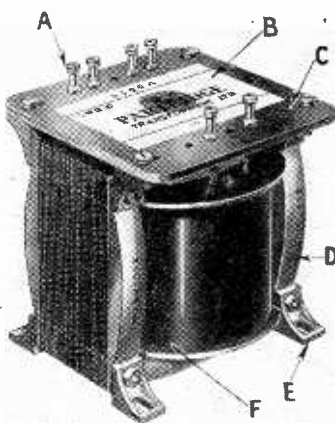

**PARTRIDGE Precision Built TRANSFORMERS**

famous for high electrical performance incorporate the following external features:—

- A** Silver plated turret terminals giving a low potential drop and carrying up to 15 amps. Adequate room on each for easy soldering of several external circuit wires.
- B** Permanent indelible marking of terminals by means of a transfer.
- C** Laminated plastic panel of the highest electrical grade.
- D** Firm clamping of the laminations by means of scientifically designed precision steel pressings with a large margin of strength.
- E** Fixing feet interlocking with the clamps so as to provide horizontal or vertical mounting.
- F** Bobbin with flanges of optimum shape for the protection of windings and location of the outleads.

The above illustrates mounting style D.N. which can be employed on all transformers wound to special order.

It should be noted that accurate fixing centres and overall dimensions are ensured by close manufacturing tolerances.

Telephone:  Abbey 2244

**PARTRIDGE TRANSFORMERS LTD**

76-8 PETTY FRANCE, LONDON, S.W.1

**I**MMEDIATE delivery, Eddystone 504 communication receiver, £48/10 plus £10/8/7 P. tax; 9-valve communication receiver, 1.2-21 mc/s, £30, c.w.o.; Eddystone, Labgear, Pullin agents; wavemeters calibrated; transformers made to specifications.—Carlton Music Salon, West Kirby, Cheshire. [6417]

**K** I.T.S. kits, kits, 2 waveband, all mains 4-K valve, tube line-up, 6K7, 6J7, 2526, 2516, polished aluminium chassis, really first grade components, station named dial, delivered complete to last nut, full wiring instructions; price £7/8, c.w.o. or c.o.d.—Isherwoods, 81, Plungington Rd., Preston, Lancs. Tel. 3548 Preston. Radio repairs. Est. 1936.

**RECEIVERS, AMPLIFIERS—SECOND-HAND**

**H**.R.O. 6 coils and power unit, excellent condition; £60.—Box 4195. [6355]

**H**.R.O. Senior for sale, 5 coils power pack, perfect condition; £55.—Box 4402. [6492]

**H**ALLICRAFTERS 5/10 receiver, new condition, been stored; best offer.—Box 3543. FOR sale, R1155 as new, complete with valves and circuit.—Offers to Box 3405.

**H**ARTLEY-TURNER 12watt amplifier.—Jones, St. Aubins, Devonshire Rd., S.W.19.

**M** IDWEST console radio, 16 valves, 11 A.C., 8-2,000m.; £42.—21, Larchfield St., Darlington. [6456]

**H**ALLICRAFTERS "Sky Champion," perfect condition, excellent receiver; best offer.—Box 3542. [6299]

**N**ATIONAL Senior H.R.O., power pack, full set coils, entirely as new; offers in region of £65.—Box 4167. [6517]

**E**DDYSTONE 358X, Xtal filter, B.F.O., A.N.L., with coils and spkr.; offers.—315, High St., Rochester. [6469]

**T**HREE-RANGE A.C. short-wave converter, W.W.9/4/37, Baker triple cone P.M. speaker; offers.—Box 4392. [6482]

**H**ALLICRAFTERS "Skybuddy," electrical handspread, etc., as new; offers please.—Warner, Mile Lane, Exeter. [6274]

**B**.T.H. Senior R.K. amplifier-speaker chassis (ac), with spare valves; £20.—Morris, 2, Cottoslee Rd., Norton/Tees. [6281]

**R**.A.F. 1155, fitted in cabinet with P.M. speaker and power pack, modified with 6V6 output; £25.—Box 4385. [6473]

**X**-R.A.F. 1155 receiver complete with power pack ac and loudspeaker.—Glass, 71, Lordship Rd., London, N.16. [6392]

**P**ETO SCOTT Trophy communication rec., 6 watts, 43 megs to 550 kcs; best offer accepted, 45s, Montrose Rd., Rugby. [6285]

**25** WATT Selby 12-volt battery amp., with remote control, crystal pick-up, motor, as new; £30.—11, Hillbury Rd., S.W.17. [6431]

**M**URPHY A28C 1938 Console overhead P.M. makers 1942. A.C. mains; £20, or offer; buyer collect.—3, Wetherby Gardens, S.W.5.

**H**ALLICRAFTER Super Skyriider de luxe, 8x17, 13 valves, 6 wavebands, separate 12in spkr.; offers wtd.—Dormers, Writtle, Ex.

**R**.C.A. AR88 communication receiver for sale, with full instruction manual, splendid condition; offers £60.—Box 4185. [6325]

**C**S. RADIO, 44, Widmore Rd., Bromley, Kent, offer small selection com. sets, radio receivers and amplifiers; list free.

**E**DDYSTONE 504 communication receiver, marvellous performance, as new, with separate speaker; best offer.—Box 4161. [6308]

**S**UPER Skyriider, SX23 (xtal filter, ANI, etc.) and DB20, both as new; may be seen London; £60 or offers.—GW3A1E, BM/3A1E, London, W.C.1. [6278]

**G**.C. L.545, all mains midget, serial no. 26295, accept £13; also 2 Ekco h.t. eliminators.—Dursley, Bloxham, Banbury.

**V**OIGT light coil twin unit with H.C. corner horn, B.E.C. corrector and power pack, hardly used, cost £47; accept £30.—Box 4151.

**"W**IRELESS World" 4-band super S.S. tuner, perfect condition, £16; also AF5, AF5c, AF3, B8, £2 lot.—Box 4225.

**S**OUND Sales 20w 230v a/c qual. amplifier, complete with radio and twin turntable gram units, needs servicing; £50.—Box 4164.

**H**AMMARLUND 12-valve comm. rec., H model 120, 1941, 600 metres 31 meg., perfect condition; offers.—Anchorsholme Cottage, Blackpool. [6476]

**R**.C.A. communication receiver, A.R.77, 10-valve, 6wavebands, 31 mc/s-c, rack type chassis, new set spare valves if req'd.; £35.—Box 3462. [6273]

**5**V radio 4-valve superhet, in carrying case 15in x 10in x 7in, spare set valves and vibrator; offers over £15.—"Blandford," Grove Rd., Tiptree, Essex. [6354]

**M**IDGET 4-valve superhet portable, completely self-contained, size 8x3 1/2 x 3 1/2 in, in perfect condition; £15 or offer.—137, Ran dall Avenue, London, N.W.2. [6468]

**12**-W. 5-valve push-pull amplifier (including rectifier), universal output transformer, H.T. and L.T. supplies included for receiver, practically new; £18.—23, Leckford Rd., Oxford. [6329]

**VORTEXION** 20w amplifier A.C., mike and chromium stand, 42in horn with unit, and 10in energised speaker; the lot 38gns.—Russell, 41, Northway, Erith. [6288]

**28-WATT** recording-reproducing P.A. amplifier, 2 input mixer, contrast expander-compressor, volume indicator, built-in monitor speaker-mic for sale; £30.—Chandler, 147A, Kensington High St., W.8. Western 9080.

**H.R.O.** Senior, 17-30 mc/s coils, separate 230v power pack; £45 or nearest; would exchange good radiogram or C.R.O.—219 (top flat), Tangier Rd., Portsmouth. [6306]

**COMM. Recr.**, 10-valve, 6-band, 1,500-20,000 kc B.F.O. crystal, A.V.C. £30 or offers; "Walkie-Talkie," No. 58, complete, £10; Avo 40, £12-3; Hungerford Av., Slough. [6346]

**EKCO** export model ac 5-wave 9-valve, cal in mcs & metres, 10-500 metres, 8 watts P.P. output with N.F.B. & var selectivity, walnut cabinet, Avo model 40; offers.—Box 4211.

**12-watt** Quality ac amplifier and sheet, 3 "w" bands, "basboost" on gram., 12in speaker, in polished solid chestnut cabinet, as new; £35 or offer.—183, Baring Rd., E.8.12.

**HIGH fidelity** amp, 12 watt output, with radio feeder unit incorporating diode detector and tone control by John Brierley, Vita-vo K12/20 loudspeaker matching output stage, new & unused; best offer over £25.—Box 4152.

**R-1155 R.A.F.** receivers as described in *Wireless World*, July, excellent condition, £15; can be supplied modified for civilian use, receivers already purchased expertly modified to your requirements, and amplifier/power packs supplied.—R.T.S. Ltd., 8, Gladstone Rd., Wimbledon, S.W.19. Tel. Lib. 3303. [5659]

**McMURDO** Silver 1940 model 15-17, outstanding receiver, 6 waveranges (including television sound), 16 valves, all controls, 200-250 ac, chromed chassis, beautiful table cabinet, separate spkr., connections for additional cabinet spkr. and for gramophone, perfect; only buyer collects Chesham; offers over £50; exceptional opportunity.—Box 3409. [6250]

**G.E.C. BCT.2360** 60 watt amplifier, used only about six times, complete with four moving coil horn speakers and six moving coil cabinet speakers, two moving coil microphones (directional and non-directional), and heavy-base telescopic stand, one horn speaker faulty, rest of speakers, microphones and amplifier in perfect condition; £100.—Elektron Services, Ltd., 56, St. Paul's Rd., Peterborough. [6389]

**TRANSFORMER**, complete with two 5mA T moving coil meters, 12 valves, dynamotor, relays, etc., bargain, £10 only; ac mains oscillator kit complete in steel case with 5 valves, mains transformer, all condensers, coils, resistances, etc., £10; acorns, triodes, 30/-; pentodes, 35/-; large carbon-anode transmitting triodes, 45/-; bargain parcels worth £25—only £10.—Brown, 63, Salisbury Av., Farnham Rd., Slough, Bucks. [6395]

**H ALLICRAFTER** S.X.28 Super Skyriter, the world's finest communication receiver, 110v, 230v A.C., D.C. power socket, 15 valves, 550 kilocycles to 43 megacycles through 6 bands, 8 watts undistorted push-pull output, 2-stage preselector, crystal, 6-position variable selectivity, electric bandspread, "S" meter, R.F. and A.F. gain controls, tone control, base on/off switch, antenna trimmer, A.V.C. selectivity control, B.F.O., crystal phasing control, noise limiter, gramophone jack, headphone jack, send-receive switch, instruction book with circuit and alignment instructions; just re-aligned, and in perfect working order; can be seen and heard working N.W. London by appt.—Apply J. K., phone Gulliver 4020.

**TEST EQUIPMENT**

**A VO** model 7, £15; Evershed megger, new, £5.—Box 4405. [6507]

**ALL-WAVE** sig. gen., £5; 3 valves, 807s, £1 each.—Box 3406. [6235]

**A VO** valve tester, new; Model 7 meter; highest offer.—Box 3520. [6284]

**SALE**, Weston analyser, 20,000 o.p.v., as new; £12/10.—Box 4306. [6427]

**CROSSOR** 339 D.B. scope, perfect condition; best offer near £40.—Box 4386. [6474]

**WESTON** 772 analyser, carr. case, exc. cond.; £17 or offers.—Box 4383. [6470]

**A VO-METER**, purchased new May, 1946, £14.—Head, 44, Robinson Rd., S.W.1.

**NEW Avo** Universal valve tester, perfect condition; £15.—Worth, 319, Gooding Ave., Leicester. [6466]

**A VO** No. 7s, £19/10; Avo valve tester, £16/10; carriage paid.—Pearce, 66, Great Percy St., W.C.1. [6327]

**TRIPLETT** 866h Uni meter, £8; Western 595a speaker, 14in. £3.—Collins, 80, The Oval, Kettering. [6275]

**A VO** 7, with case and voltage multiplier, complete, brand new; best offer.—Barnes, 64, Brightwell Av., Westcliff, Essex. [6488]

**UNIVERSAL** Avomirror, little used, £5; 0-100v ac meter, no scale movement 0-1 ma, 25/-; 0-50 micro-ammeter, 35/-.—Box 4399. [6489]

# RADIO CORNER

(Proprietor, T. R. WILLIAMS)

138 GRAY'S INN RD., LONDON, W.C.1  
Terminus 7937

**MAIL ORDER.** Delivery by return. THE BANNER CHARGER. Type 1/1, 1 amp, ideal for Motorists, a really first-class job. Input 240 v A.C. Output 2, 6 or 12 v D.C., at £3. Designed for the motorist who likes to keep his batteries in tip-top condition.

**RADIO VALVE MANUAL**, giving American and British Valve Equivalents and Data. Price 3/6. Radio Constructors Manual. Price 3/-. Radio Tuner Unit Manual. Price 2/6. Engineers and Electricians Handbook. Price 1/- Cathode Ray Oscilloscope Manual. Price 2/-. Radio Reference Book. Price 12/6.

American Radio Valves. Types as under at controlled prices. 45Z5GT, 5Y3G, 1A5GT, 1C5GT, 1Q5GT, 1T5GT, 80G, 35Z5, at 11/- each. 6J5GT, 12J5GT, 1H5GT, 12S5FGT, at 9/2 each. 6Q7GT, 12Q7GT, 12S07GT, 75G, at 11/7 each. 12SK7GT, 6K7GT, 6K6GT, 6V6GT, 4Z6, 43G, at 12/10 each. 6A7G, 6A8GT, 6K8GT, at 14/- each. Postage paid. Other types as they become available for distribution.

## AMERICAN RADIO SERVICE MANUALS

- Volume I. Spartan Emerson.
- II. Crosley Belmont. Part I.
- III. Crosley Belmont. Part II.
- V. Emerson. Part II.
- VI. Stewart Warren. FADA.

At 12/6 per Volume, or complete set of six manuals £3 12s. 6d. These Manuals cover the complete range of American Radio Receivers as given and are invaluable and contain all the technical data necessary.

**Terms.** Cash with Order only. We regret that we are unable to end goods C.O.D.

**A S** new, Taylor 90A, 40 range; G.E.C. Select-est II; also few 3 waveband packs.—Offers Telfer, Newcastle, Roxburghshire. [6459]

**A VO** mains oscillator, also valve tester, both new, unused, list price.—N.R.S., 66, Parkhill Rd., London, N.W.3. Gulliver 1453. [6355]

**TAYLOR** 45A valve tester, new, exchange Taylor 65B, signal generator, similar condition, on sale, £18/10.—16, Alvista Ave., Taplow, Bucks. [6357]

**B** BRAND new model 40 Avometer, £17/10; B Universal Avo Minor, £8/10; dc Avo Minor, £4/4; all unused.—Weatherhead's, Bletchley, Bucks. [6178]

**P** ORTABLE oscillator, 125k/cs to 20,000 k/cs, extremely accurate, also calibration book and manual; £10.—40, Kitchener Rd., Weymouth, Dorset. [6422]

**M**OVING coil meters, Weston type 301, 2 1/2in. flush mounting, 15ma, 300ma-2, 80v, 32; 25/- each, carriage paid.—Brown, 4, Julian Rd., Folkestone. [6382]

**A VO** model 40, brand new, £16/10; Weaire meter (modified), 10 ranges, volts, amps, ohms, £6.—Details from Pendleton, The Willows, Mountsorrel, Leicestershire. [6471]

**A VO-MINOR** Universal, complete with leather carrying case, brand new, unused, purchased surplus to requirement; £8.—H. Cushman, 34, Vale Court, London, W.3. [6259]

**U**SED multimeters, Taylor 83C, 20,000 ohms D, Avometer, Avo No. 40, Avo D, Avo D models, all ac-dc; offers for the 4, or will separate.—66, Selton St., Southport, Lancs. [6471]

**D**ESIRE a C.R.O. ex-Service mechanics? What offers? indicator 10QB/24, similar Navy design L-M or N, 2 in number, with and without V.C.R.97; no callers.—15, Dragon Sq., Chesterton, Stoke-on-Trent. [6356]

**F**OR sale, latest model Weston analyzer, unused; also 12in. Magnavox speaker with built-in energizing powerpack, as new; what offers? Will sell separately; can be seen by appointment.—Apply Pack Horse, Staines.

**T**ESTING equipment for laboratory and factory designed and manufactured by expert engineers; all types of non-standard equipment for research or mass production; free consultations.—Gamma Electronics, Ltd., 12, Greenford Rd., Greenford, Middlesex, Tel. Warrlow 3152. [6377]

**M**ETERS: 50 micro amp, 3 1/2in. flush, £65/-; 5mA, 2in, 45/-; 3amp, thermo-couple, 2in, 25/-; 40mA and 120 mA dual range, 2in, 35/-; all new moving-coil meters, 10mA, 2in, 35/-; 10mA, 3in, 40/-; 25mA, 3in, 40/-; 30mA, 2in, 35/-; 5amp, 2in, 25/-.—Brown, 63, Salisbury Av., Farnham Rd., Slough, Bucks. [6394]

**A LL-WAVE** signal generator, non drift coil, 100kc (pat. pending), 400 cps. anode modulation, cathode stabilised oscillator, scale calibrated 30 mc/s-100kc/s, 10-3,000m, ruggedly constructed for use in vertical or horizontal position, self-contained handle, integral storage for mains and output leads; 10 1/2gns; orders in rotation.—R.R. Development Laboratories, Ltd., 26, Hawes Rd., Bradford. [5929]

**M**ODEL 120 Clough-Bregle 20,000 ohm p.v. analyser, £22; special Avo 20,000 o.p.v. analyser, combined with slide-back valve voltmeter and 500v insulation tester, £25; several others; loudspeakers, all 15 ohms input; Baker's 18in cinema, 2,000 ohm field, £8; Siemens-Halske Riffe, perfect and with spare diaphragm and field supply, £7; American Rohas, 11in, 2,000 ohm field, £4; 9in, 4,000 ohm field, £3; 9in, ac field supply, £2; 16in p.m., £10; microphones, Standard Telephones moving coil, in ebonite case, £10; in chromium table stand, £13; Rothermel senior pickups, new and boxed, £2/10; many other components.—Pickering's, 32, Sherington Ave., Hatch End, Middlesex. Hatch End 789.

**VALVES**

**1T4s**, 17/6 each, all unused; cash or c.o.d.—Box 4213. [6406]

**1L4**, 3Q4, 3A4 miniature valves, new and unused, 12/6 each.—Box 3466. [6281a]

**P**15s, 384s, 1R5s, 1T4s, 20/- each, all unused, guaranteed.—Box 4206. [6378]

**1R5**, 1R5, 1T4; £1 each, brand new.—D. Conway, 29, Pattison Rd., N.W.2.

**TWO** GU5s, 25/- ea; 2 KT8Cs, 24/- ea; 2 467s, 35/- ea; 2 4672s, 40/- ea. [6458]

**GREGG** 99, Hawthorn Rd., Ashington.

**M**INIATURE valves, 1R5, 1T4, 1R5, 1299, 15/6 ea, all brand new.—V.E.I. Corp., 32, St. Gabriel's Rd., London, N.W.2. [6479]

**Y**OUR offers for 9002, D.1, 832, 807 (2), P.X.25 (4), 35.T (3), 9003 (3), E.A.50 (5), DET.19 (2), 6L6G (2), 6J5GT (4), all new.—Box 3459. [6265]

**T**ELEVISION cathode ray tubes for sale. 10in Mullard, E.46.10 electrostatic, £6; 12in Baird Cathovisor, electromagnetic, £6/10.—Box 4403. [6497]

**T**ELEFADIO offer one only 12in Ediswan C.R. tube, type CRM 121, complete with scanning coils and mounting assembly; 15gns.—Callers only, 157, Fore St., Edmonton, N.18.

## Specialists in

HIGH POWER - HIGH QUALITY

# PUBLIC ADDRESS SYSTEMS

★  
AMPLIFIERS

from 150 W to 1kW

W. Bryan Savage Ltd

WESTMORELAND ROAD, LONDON, N.W.9

Telephone: Colindale 7131

100 brand new boxed American transmitting valves, General Electric, etc.; offers over £1 each; also 616, 6C6, 5Z3, 41 and 6A6, list prices each; new high voltage condensers, etc., cheap; all ex-U.S. Navy.—Richards Radio, Menai Bridge, Anglesey.

**NEW LOUSPEAKERS**

£5/18/6.—New Baker Super Quality 12in Auditorium permanent magnet speaker with triple cone, manufactured by Bakers Selhurst Radio, the pioneer manufacturers of moving coil speakers since 1925, wide frequency range, even response, ideal for quality reproduction, fitted with magnet, having exceptionally high flux density in the air gap suitable for public address equipment when quality reproduction is first consideration, and 2½d stamp for leaflet giving details of above and constructional details of a new acoustic chamber designed to extend loud speaker frequency range.

£8/19/6.—New Baker super power cinema permanent magnet speaker with 18in triple cone of new design, giving wide frequency response free from objectionable resonances; speech is clear and natural and music is reproduced with exceptional realism; fine engineering job, extremely sensitive; ideal for public address equipment when power handling capacity, plus realistic reproduction, is required; prompt delivery per pass. train.—Bakers Selhurst Radio, 75 Sussex Rd., S. Croydon (Croydon 4226).

HIGH quality, precision-built speakers, with Ticonal magnets, detachable diaphragms, die-cast chassis, twin cone.—Broadcast & Acoustic Equipment Co., Ltd., Broad-st. House, Tombland, Norwich 26970. [6435]

**LOUDSPEAKERS. SECOND-HAND**

HARTLEY-TURNER standard a.c. model with rectifier; £5.—Box 4160. [6307]  
HARTLEY-TURNER energized, O/P trans.; £5/10.—Reynolds, 46, Westwood Park, Forest Hill, S.E.23. [6480]

BAKER triple cone de luxe SQPM Auditorium, £6 (list £7/15).—Rowley, 55, Kingsfisher Court, East Molesey, Surrey. [6245]  
CODMAN'S 10in twin cone, H.F.F.; £3/10; Baker's 12in Auditorium, £3/10; Marconi 25P.U., 24/—Seymour, 19, Parkhurst Court, Holloway, N.7. [6331]

VITAVOX K12/20 loudspeaker, mounted in massive mahogany box baffle, and 15-watt hi-fidelity amplifier; £18; buyer collects.—7, Athelstan Lane, Otley, Yorks. [6454]

**DYNAMOS, MOTORS, ETC.**

ROTARY converter, Crypto radio filter, silent, cabinet, 220v dc-230v ac, 8a, 180w, just received; £25 or offer.

FOUND Sales super auditorium 12in speaker; £4.—Siggers, London Rd., Bracknell, Bucks. Tel. 435.

FRAGMENTAL hp ac motor, 4-pole induction, 1,250 r.p.m., 47 watt rating, new, perfect; 58/—45, Sandgate Rd., B'ham, 28.

D.C. converter, silence cabinet and filter, 230 D.C.-230 A.C., 120 watts; & trailer and other service sheets; offers.—Box 3523.

COMMUTATORS, 3,000 surplus for disposal, 25-32½in, 12 bars.—Apply H. Frost & Co., Ltd., Fieldgate, Walsall. Tel. Walsall 2218.

ROTARY transformer, 12 volts D.C. to 475 volts A.C., 200 ma, unused, excellent condition, ball bearings, double commutator, £3/10.—C.D.P., 62, Second Ave., Chelmsford, E.

ROTARY converters, 12 volt dc input, 480 volt 40 ma or 460 volt 80 ma output etc, brand new and tested, still in original boxes; to clear 17/6 each.—Box 4201. [6362]

BATTERY chargers for home and export, 4 models, 2-6-12v, 1, 2, or 4amp dc, any mains voltage; generous trade terms. Write for catalogue. Tel. Hoddesdon 2659.—The Banner Electric Co. Ltd., Hoddesdon, Herts.

ROTARY transformers, with 6v input, output 200v 50 ma, with 12v input, output 480v 40 ma continuous or 400v 80 ma for periods up to 3 hours, 19/- each; 5in P.M. speakers 21/-, 2½in P.M. speakers 25/—M.O.S., 24, New Rd., London, E.1. [6220]

MAINS transformers, 200-250 volts, 350-0-350 at 80ma; heaters, 5 volt at 2amp and 63 volt at 4amp, complete with mounted and wired valveholder (octal) for rectifier; limited quantity only at 20/- each, carriage paid.—Dept. W., Radio House, 67, York Rd., London, S.E.1. [6423]

GRAMPHONE and SOUND EQUIPMENT VOIGT twin unit, just overhauled by Voigt, 77, Wellington Rd., Enfield. [6260]

RADIOGRAM, W.W. 2HF-QA, in H.M.V. record-changer cabinet; £58.—Box 4484.

PLAYING disc, complete with ac 115v motor, less pickup, ideal for building into amplifier; 50/—Warren, 32, The Avenue, Kew Gardens. [6446]

PULSAGRAM, fitted H.M.V. hypersensitive pickup, £15; Lexington moving coil pickup, pre-amplifier, 2 sapphires, £11.—Stamp, Farm Wood, Bolney, Sussex. [6800]

**Quality Bargains offered by ELECTRADIX RADIOS**

METERS. D.C. moving coil Micro Ammeters—new, 2" flush panel, zero adjustment, 500 ohms resist., 500 micro-amps, 60/-; D.C. moving coil Milli Ammeters, 0-1 m/a, 2½" dia., 55/-; 4" dia., 70/-; double range, first grade m.c. Voltmeters, 0-10v and 0-40v, by Elliott, 55/-; D.C. Moving Coil Ammeters, Elliott, 2½" dia., 2.5 amps, 55/-; D.C. Ironclad switchboard meters, 4" to 6" dial, from 15/- each. Send your enquiries.

D.C. MOTORS. Shunt wound K.B.B. motor, 110 volts, protected type, 2,000 r.p.m., 1/100 h.p., with 20/1 reduction gear, mounted on C.I. base, 45/-; ½ h.p. 210 volts shunt, £7; 1.6 h.p. 220 volts shunt, by Newton, 2,500 r.p.m., ball bearings, £12.

A.C. MOTORS. 400/440v., 1/3 h.p., Met. Vick., 50cy., 3 ph., 1,425 r.p.m., £9; ½ h.p. 415 volt, 50 cy. 3-ph., Fuller, 1,500 r.p.m., £10; 1.h.p. 200v., 50 cy., single phase variable speed motor, Bandy make.

RELAYS. We have large stocks for immediate delivery; surplus G.P.O. Relays, 1,000 ohms, 6 volts, 4 m/a.—on-off, 7/6; 1,000 ohms, 25 P.C.O., 5/-; 500-1,000 ohms, 2 makes, 5/-; 2,000 ohms, 2 make, 1 break, 1 C.O., 7/6; 2 make, 2 break, 7/6; 1 make, 2 break, 5/-; 3 make, 2 break, 2 C.O., 10/-; 1 make, 4 C.O., 7/6, and many others. Send for Special Relay Leaflet "W.W." TUBULAR AERIALS. 12 foot tubular aerials for ultra-short and broadcast; 5 metres upwards for Receivers and Transmitters; duralumin seamless tubes ¾", useful for many purposes. Packed in cartons, post free for 4/6.

POLE STAY STRAINERS, for aerial masts, transmitting and television, 1/6 each; postage 6d, extra.

INSULATORS. Swan-neck insulators for gutter fixing, 1/6 each. Millroy 12 volt battery type in metal can, 15/-; Special 12-volt transformer, 27/6. Vibrator contacts, thin H.F. reed, bakelite mounted, fine thread adjustment, milled locking nut, Gov't type, 4/-.

TELEPHONES for House and Office. CONSTRUCTORS PARTS FOR YOUR OWN SET UP!

- WALL TELEPHONE SETS.  
Bracket Mike, vertical or horizontal..... 10/-  
Transformer and Condenser for same ..... 5/-  
Magneto Bell fitted ..... 3/-  
Switch hook and contact ..... 2/6  
Walnut Cabinet 8" x 6" x 3" fitted terminals and connections ..... 5/6  
Two L.R. wath pattern earphones ..... 10/-  
Hand Magneto Ring ..... 10/-  
SET As above 30/- or 50/- per pair.

MAGNETS. D.C. Electric magnets, weight 10 oz., lift on 2 volts, 1½ lb., 4 volts 3 lb., 6 volts 4 lb., new surplus, 7/6 each. Permanent powerful flat bar magnets, 2½" x 1" x ¾", drilled 2 holes each end, for any pole pieces, 2/- pair. AC/DC mains magnets, 2-pole, 220 volts, 7/6. The wonder Midget magnets, Alni perm steel disc; ¾" dia., ¾" thick, with 3/16" centre hole, 3/6 each. Large stock of Horseshoe magnets. Send for special Magnet Leaflet "W.W."

BUTTON MICROPHONES provide interesting experiments for making outside listeners, sound transmission, etc. These ex-G.P.O. Voice units are under 1in diam., filled carbon granules at fitted mica diaphragm, 3/6 each. Special transformer and Condenser, 5/-. Instruction Leaflet with each Button. G.P.O. Mike insets, 3/6. Special armoured inset, latest pattern, 5/-, useful for making a Home Broadcaster.



INVISIBLERAY CONTROL. Raycraft Kit, comprising Raycellin bakelite container, with terminal 10,000 ohm relay, megastat, resistance, condenser, valve holder and connection wires, with Instructor's Booklet, 42/-.

PARCELS 7 lbs. useful oddments for the junk box. All clean and dismantled from Government and other surplus apparatus, 7/6 post free.

**ELECTRADIX RADIOS**

214, QUEENSTOWN ROAD, LONDON, S.W.8

Telephone: MACaulay 2159

COIL pickup and Lexington pickup, both complete, perfect; £5 each.—4, Timms Rd., Banbury, Oxon. [6451]  
FOR sale, Voigt twin unit corner horn with base chamber and power supply, perfect condition; offers.—Box 3458. [6263]

RECORDING machines and all accessories, R discs, cutters, motors, etc.; mobile unit available for work anywhere in Britain; 16mm sound films produced.—Spondon Sound Service, Spondon, Derby. [6478]

COILS for "W.W." tone control and filter circuits (Brierley & Hartley spec.), high fidelity, mic. line and output transformers; s.a.c. full list.—R. Clark, 30, Langland Cres., Stanmore, Middx. Wor. 5321. [6403]

AMERICAN gramophone and transcription portable unit, 2½in x 15¼in x 11¼in, Westinghouse crystal pick-up, twin clockwork motors, 33½ and 78 r.p.m., excellent condition; what offers?—Box 4162. [6309]

MAKE your radio or gram. live with the Holmer treble-bass "tone control unit; lifts treble or bass independently; gain sufficient for low output pickups; built on chassis 10in x 6in x 3in; price £6/15.—Box 3401.

INFINITE Baffle corner deflectors, scientifically designed acoustic chambers as reviewed "Wireless World," June; send for catalogue.—Broadcast & Acoustic Equipment Co., Ltd., Broadcast House, Tombland, Norwich 26970. [6434]

A COMPLETE disc recording service, disc blanks, cutting and reproducing sapphires, cutter heads, and first-class recording machines, your own sapphires reground at 5/6 each.—Technifon, Ltd., 99, Belgrave Rd., S.W.1. Vic. 8914. [6323]

EXPERT non-metallic needles.—We have over twenty-five years' experience in the selection, grading and special treating of Thorn needles; for use in pick-ups; type A, thick, type B thin, 3/- per 10, including purchase tax; sharpener, 7/4; guaranteed harmless to the record.

EXPERT GRAMOPHONE & RADIO, Ltd., Ingerthorpe, Great North Rd., London, N 2

PROFESSIONAL recording equipment, MSS. recording machine, 20 watt amplifier, complete, £100, new, from stock; blank discs, etc.; full range Sound Sales equipment available; Garrard transcription motors and playing desks.—Liverpool Sound Studios, 83a, Bold St., Liverpool. [5348]

VALRADIO moving coil pick-up, response 25-12,000cs, £8/10, plus 1¢/10/6 P.T.; high gain quality amplifier, 2 PX4s in push-pull, 2 inputs, 2 output impedances, £18; sapphire needles for Valradio pick-up, 15/-; for standard pick-ups, 12/6.—Valradio, 57, Fortress Rd., London, N.W.5. [6397]

H.M.V. auto-radiogram, in handsome walnut case, and an Ultra electric radiogram, to be offered for sale by auction on premises at 139, Sydenham Hill, S.E.26, on Tues., 10th Dec., 1946, at 10.30 a.m.—Cats, price 6d. from the Auctioneers, Marten & Carnaby, F.A.I. adj. West Dulwich Stn., S.E.21. Gipsy Hill 1144.45. [6437]

A NEW 1946-7 all-wave radiogram of quality Polyphonic, £82/0/3, including tax; automatic record changer model, £100/7/9, including tax; post orders guaranteed (rotational); a pleasure to send full details; large s.a.e. speeds reply.—SNELL, Arcade, Swansea. Established 1900. Tel. 3784. [6184]

RECORDING machine, complete with heavy duty motor (ac), heavy table, stroboscopic apertures, cutting head, playback p.u., crystal mike on table stand for above, Telefunken sapphire p.u. with transformer mounted on heavy motor; 1155 receiver; short-long wave receiver, 2 r.f., 3 i.f.; 200-50 kc/s, 1.5-18 mc/s; power pack, 240 ac. for above; Baker Selhurst 12in p.m. speaker.—Offers to Box 4162.

EXPERIMENTER'S special High Fidelity pick-ups for sale; unique opportunity for enthusiasts; all in perfect order, only slightly used; Brush peizo-electric laboratory High Fidelity Model P.L.50, only one in the country, permanent sapphire Stylus, £15; Telefunken high quality pick-up, with permanent sapphire Stylus, purchased 1945, £5; 2 Lexington high quality pick-ups, complete with sapphire Stylus, transformers, Mu-Metal boxes, £6/5 each.—Box 4408. [6515]

TRANSMITTING EQUIPMENT R.A.F. T.1154, excellent condition; £15.—Box 3464. [6280]

COMPONENTS—SECOND-HAND, SURPLUS SPARES for R.A.F. type 1154 transmitter.—Write Box 4393. [6483]

G5NI RF60 transmitter, power pack, meters and rack, in good condition.—Hallsworth, 1, Southampton St., Farnborough, Hants. [6258]

CIRCUITS.

DORSET new battery superhet. 4 valve, all dry 3 wave; Dorset 5 valve 3 wave superhet; Dorset A.C./D.C. 4 valve 3 wave superhet; Dorset A.C./D.C. amplifier, 6-8 watts; A.C./D.C. 4 valve T.R.F., M.W. with L.W. conversion.

DORSET manuscripts containing 5 or 6 pages of drawings, point to point wiring instructions, etc., 5/- each post free. Theoretical circuit of superhets with price list, 2/6d. each.—Weldona Radio Accessories, Ltd., Swanage. [6315

SUPREME RADIO.

746B, ROMFORD RD., Manor Park, London, E.12. Est. 15 years.

NEW lines for the service engineer: 2-gang 0005 condensers with fixing feet, 11/-, 3-gang 13/-; line cord, 5-way 60-70 Ω/ft, 15-oz yds; dials, all-wave ivorine, 3 1/2" x 4 1/4" 6in x 6in 2/-, M. & L. 1/6; midget chokes, 60 mils 6/-, 100 mils 1/6; 0.3 droppers fixing feet, 3/9; v/cs with sw.; best makes 4/-, less sw. 5/8; wire wound, 10,000 less sw. 5/-; 2,000 Ω v/cs, job line to clear, 18/- doz; cardboard 8mfd condensers, 30/- doz, 25-25 18/- doz, 50-12 18/- doz; 0.1 tubular condensers, 500v working 4/- doz, 0.01 4/- doz, 0.25 metal wire ends fixing clip, 9/- doz (carbon resistances, 1/2 watt, 200 Ω 470, 1,000, 10,000, 20,000, 27,000, 100,000, 250,000, 250,000, 270,000, 560,000, 1 meg 1.5 2.2 meg 3/- doz) (1 watt 47 Ω 12,000, 20,000, 75,000, 100,000, 150,000, 4/- doz) (2 watt 10,000, 23,000, 56,000, 5/6 doz) all known makes, wire wound, 1/2-1.2 watt assorted 500 Ω 1,000, 1,400, 1,500, 1,700, 2,500, 3,500, 5,000, 6,000, 12,000, 13,000, 14,000, 15,000, 45,000, 60,000, 65,000, 80,000, 90,000, 100,000, 120,000, 2/6 doz. MIDGET speaker trans., 4/6; sleeving, 3/- doz yds; screen caps, 8/- doz; non-ringing valves equivalents 80 5Y3 6J5 7J6; "Airmaster" radio console table or chassis, delivered from stock.

S.A.E. all enquiries; terms, cash with order, no o.d.; send 6d. extra for postage and packing all orders under £5. [6366]

SOUTHERN RADIO'S wireless bargains.

LATEST radio publications.

"RADIO Valve Manual," equivalent and alternative American and British types with all data, 3/6; "Radio Circuits," fully illustrated receivers, power packs, etc., 2/-; "Amplifiers," fully descriptive circuits, 2/-; "Radio Coil and Transformer Manual," 2/-; "Short-Wave Handbook," 2/-; "Manual of Direct Disc Recording," 2/-; "Test Gear Construction Manual," 1/6; "Radio Pocket Book," formulas, tables, colour code, etc., 1/-; "Ten Hows for Radio Constructors," 1/-; "Radio Reference Handbook," cloth bound, comprehensive and up-to-date, covering all branches of radio, 12/6; "American Service Manuals," Sparton-Emerson, Crosley-Beimont (Parts 1 & 2), Stewart-Warner-Fada, Emerson, 12/6 per volume; "Radio Resistor Chart," colour codes at a flick, 1/- each; "Bulgin Radio Service Manual," 2/6; "Radio Constructor's Manual," 5/-; postage extra.

YAXLEY type 11-way rotary switches, 5/-; tubular condensers, 0.1+0.1-0.1 (cans), 2/6; resistances, brand new wire-ended, 1/4, 1/2 and 1 watt, assorted values, 30/- per 100; 1/2-watt only, assorted values, 20/- per 100; 1/2-watt, 22/6 per 100.

"P.O." microphones, complete with transformer, useable with any receiver. 7/6; permanent crystal detector, 3/6; insulated push back wire, 25 yards, 5/-; insulated sleeving, assorted sizes and colours, 3/6 per doz yard lengths; single screened wire, 7/6 per doz yards; twin screened, 15/- per doz yards; aluminium panels, un drilled 16 gauge, 18in x 7in, 3/6; 18in x 9in, 4/6; ceramic and paroline postage stamp trimmers, 30/4 min-ble, 1/3 ea. double bank 2/-; Cutler Harmer power rheostats, 30ohms, 4/6; power rheostats, 10ohms, 4/6.

LUFBRA adjustable hole cutter, use on metal, wood and plastics, etc., 5/- ea, including postage; a large assortment of ex-Government material in stock.

R.A.F. 1155 receivers available from stock, these have been pre-tested and guaranteed, complete with plug, £15/15 (carriage and packing 7/6 extra); spare 1155 plugs, 8/6 ea.

SOUTHERN RADIO SUPPLY CO., 46, Lisle St., London, W.C. Gerrard 6653. [6411

SURPLUS of all types new radio components for sale; great opportunity.—Box 3521.

POWER Pack, 1,500v, 650v, 4 m.v. rectifiers.—Tel. for details, For. 3304. Box 4118.

QTY 46G enam silver wire.—Delta, 612, Q London Rd., Westcliff. [6464

NOTES, 700 gross surplus for disposal, 1/2eln N Whit, Simmonds No 2BA/T/M.S.—Apply H. Frost & Co., Ltd., Fieldgate, Walsall, Tel. Walsall 2218. [6370

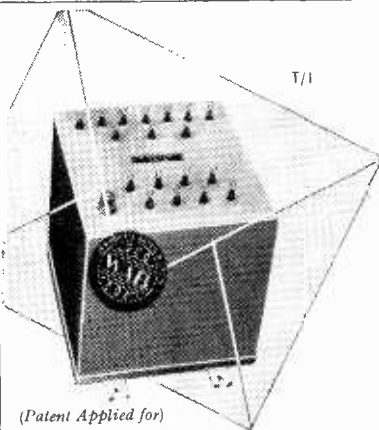

(Patent Applied for)

HERMETICALLY Sealed TRANSFORMERS

Designed during the war to meet Service requirements for a Transformer which would operate efficiently under extreme Tropical conditions. Sealed against humidity, termites and other pests. Now in production for general industrial use. Write for full particulars and specifications.

W. ANDREW BRYCE & CO. LTD. Shenley Road, Boreham Wood, Herts Telephone: ELStree 1875 & 1117.



It's hot—all the time. That's because the heating element is housed inside the bit in the Solon Electric Soldering Iron. Soldering is easier; you get a neater, cleaner job in less time. All internal connections are housed at end of handle away from heat. A robust cord grip prevents sharp bending of the flexible lead. Complete with Gt. of Henley 3-core flexible. Solon irons are made to the following standard voltages—200, 220, 250.

Made in England.



W.T. HENLEY'S TELEGRAPH WORKS CO. LTD. Engineering Dept., 51-53, Hatton Garden, London, E.C.1.

VALUE! Matt has it!

SPEAKERS: 5in L/T., 15/6; 6in L/T., 17/6; 8in L/T., 22/6; all P.M. ZETHERMEL; crystal pick-ups, de luxe 42/16/3, including purchase tax.

VOLUME controls: Centralab. all values, 2/6 L/S; 3/6 W/S. CONDENSERS: all 500v working, 8mfd. 2/10; 8-8, 4/9; 0.01, 0.05, 0.1mfd, 6/- per doz.; 4-4 100mfd 350 working, 2/6 ea. INTERNATIONAL Octal valve holders, 3/- per doz, 30/- gross lots; 4-, 5- and 7-pin, 6/- doz.

LINE cord, 2-way, 1/- per yard; 3-way, 2/- per yard; 0.3amp 60ohms per ft. 100 YD coils 5mm flex, 12/6 a coil; 5amp 3-pin flush shuttered switch plugs, 8/6 each. LARGEST stock of B.V.A. and U.S. valves in England. We supply anything in radio.

MATT RADIO SERVICE (Kin. 4881) 152, Richmond Rd., Kingston-on-Thames, Surrey.

SCOTLAND'S largest stockists.—Anything S radio we have it.

EDDYSTONE agents—Raymart. SEND for parts and kits list.

BUCCLEUCH RADIO MANUFACTURERS, Melville Terr., Edinburgh. Tel. Edinburgh 42803. Grams, Therm. Edin. [5139

CHARLES BRITAIN RADIO offers new bargains in radio spares.

MALDEN transformers, fully shrouded with feet, 350-0.350 80 ma 4v and 6v types, 27/6; ditto heavy duty, 120 ma for 2v, 4v and 6v heaters, and 4v, 5v rectifier, winding, 35/-; tuning condensers, three-gang 0005 ceramic insulation, 10/-; two-gang ditto, 10/-; two-gang with feet, standard type, 11/6; coils, superhet Ae and Osc all-wave with diagram, 14/-; TRF coils, dual band with reaction and diagram, 8/6 pr; I.F. transformers, 465 kc, air core, 12/6; iron-cored, 14/- pr; wavechange switch, 4-pole 3-way, 4-pole 2-way, 3/6 ea. 2-pole 2-way, 2/9 ea.

LOUDSPEAKERS, 8in, less trans P.M., 24/6; with trans, 30/-; 6in Goodmans, less trans, 25/-; 5in, less trans, 21/-; 12in Goodmans, £6/15; 12in Vitavox, £7; speaker transformers, midget for pentode or power, 5/-; standard-type pentode, 6/6; multi-ratio 10-watt, 7/6; heavy duty multi-ratio, 30watts

18 ohms, 25/-; 6L6 type, 27/6; chokes 350 ohms 60 ma midget, 5/6; 350 ohms 80 ma standard, 6/-; heavy duty choke, 450 ohms 200 ma, £1; electrolytics, 8-16mfd can 450v wkg, 6/6; 8-8mfd, 8/-; 16mfd can, 4/6; 8mfd can, 3/-; B.I. blocks, 8mfd 450v wkg, 3/-; 25mfd 25v, 50mfd 12v, 75mfd 12v, 1/9 ea; line cord, 3-way 0.3 amp, best quality, 60/70 ohms, per foot, 1/6 per yd; droppers with fixing feet and slider, 2 amp 1,000 ohms, 4/6; 3 amp 850 ohms, 5/-; midget chassis drilled 5 valves, 9x4 1/2in, 2/6 ea.

SPECIAL offers: Moving coil mikes, undamaged, in metal case with grille, 5/- ea; damaged, 1/6; parcel of 36 assorted tubular condensers from .001 to .1mfd, 10/6; parcel of assorted 72 1, 1/2 and 1/4 watt resistors from 100 ohms to 1 meg, 12/6; special parcel containing chassis, valveholders, coils, i.f transformers, tag bars and 24 new condensers, £1; splendid value.

NUMEROUS other lines in stock, including amplifiers, pick-ups, etc.; callers always welcome; trade supplied; terms c.w.o. or c.o.d. £1.—Charles Britain (Radio) Ltd., Radio House, 2, Wilson St., London, E.C.2. Tel. Bia. 2966. [6455

ALIGNED INSTRUMENTS SERVICES, 1, Colworth Rd., Leytonstone E.11.

TUNING Heart kits.—Each kit includes a coil pack and i.f. transformers which have been pre-aligned and gain tested, matched gang condenser, and the components which are specified in the recommended circuit which is supplied; i.f. transformers are iron cored and permeability tuned; for coil pack details see below; superhet types: Kit No. 5, 16-50, 200-550, 750-2,000 metres; Kit No. 6, 12-30, 30-75, 75-200 metres; Kit No. 7, 16-50, 200-550 metres; Kit No. 8, 200-550, 750-2,000 metres. T.r.f. types: Kit No. 9, 16-50, 200-550, 750-2,000 metres; Kit No. 10, 12-30, 30-75, 75-200 metres; Kit No. 11, 16-50, 200-550 metres; Kit No. 12, 200-550, 750-2,000 metres. Prices: Kits 5 and 6, 75/-; Kits 7 and 8, 63/-; Kits 9 and 10, 60/-; Kits 11 and 12 50/-; Matched valves supplied for Kits 5, 6, 7, 8, at 38/3 extra; Kits 9, 10, 11, 12, at 25/8 extra; circuit diagrams supplied separately, price 2/6.

BOX containing spares, including valves, speech transformers, quartz crystal, resistances, condensers, etc.; £3.—Box 3525.

EXPERIMENTER'S stock, including instruments, valves, electrolytics, etc., hundreds of resistances, condensers, £25; s.a.e. list.—M.V.A. TRANSCRIPTS, W.C.1. [6333

GENUINE pre-war roof top car aerials, rubber suction fitting, 25/-+carr.; brand new rotary converters, 12v, input 490v 65u, £11/4+carr.—Ingils, Bury St. Edmunds. [6496

**G. W. SMITH & Co. (RADIO), Ltd.**, offers the following:—  
 81L mica condensers, 2%, 500, 440, 100 80, 50, 40, 25 P.P., 4d ea. 3/; per dozen: 0.1, 0.02 tub, 6d; 0.1 1,000V, 1/; 0.02 1,500V, 1/; 0.1 mica, 1/-; resistances, 7,000, 5,000, 1,000 ohms, 1 watt, 4d; 15/45pf ceramic double trimmers, 1/; Westinghouse meter rectifiers, 5 m/a, 7/6; sleeving, 1 m/m, 2d yard; transformers, 500, 450, 400ct, 12, 6v C.P., 4v 2a, 4v 2.5a, input 200/250, 45/-; Tannoy service hand-type microphones with built-in switch, multi carbon, 7/6; chassis 10x6x3, 2/-; 2 mfd 250v, 1/-; 1 mfd 400v, 1/6, plus postage.  
**G. W. SMITH & Co. (RADIO), Ltd.**, 2, Cecil Rd., Southgate, London, N.14. Tel. Enterprise 5463. [6268]

**SELENIUM** metal rectifiers, charger kits, rectifier conversions.  
**ALL** new goods, no surplus stocks, charger kits guaranteed one year.

**LARGE** selenium metal rectifier, 12v 3 amp type, with 50 watt transformer and ballast bulb for 2v to 12v charger, weight 7lb, no rheostat or ammeter required, 47/6, post 1/-; ditto with 2 amp rectifier, 39/6; ditto 1.5 amp, 37/6; ditto, but for 2v and 6v only, at 1.5 amp, 28/-, post 10d; above kit also supplied with 75 watt transformer and 4 amp rectifier for 2v to 12v, at 59/6, post 1/-; heavy duty transformer, weight 9lb, and 12v 5 amp rectifier, with fixed ballast resistor and fuse block for 6v and 12v charging only, 24/5; trickle charger rectifier, 2v 0.5 amp type with transformer, makes ideal charger for 2v cell, 13/6, post 7d.

**RADIO** store kits, transformer 120 watt, with metal rectifier and ballast bulb for one to 20 cells at full one ampere, guaranteed one year, 25/5; ditto, but for 2 amps, 27/5; will earn their cost in short time, handle over 80 cells per week.

**SELENIUM** metal rectifiers, not surplus, 12v 1.5 amp, 10/6, post 6d; 12v 2 amp, 15/-; 12v 0.75 amp, 7/6; 12v 3 amp, 21/-; 12v 4 amp, 27/6, post 8d; 12v 5 amp, 32/6; instrument rectifiers, M.B.S., 1, 1ma, and also strings for Avo, Avominer, new, maker's wrappings, 12/6.

**LATEST** small selenium eliminator rectifiers, 120v 25ma, 7/-, post 4d; also for ac/dc sets, 250v 60ma, 12/6; eliminator kit, transformer, metal rectifier, two 8mfd condensers, smoothing resistance, for 120v 20ma eliminator, 35/-; ditto, but with 2v trickle charger, 39/6, post 8d.

**ALL** types metal rectifiers in stock for converting valve type chargers to metal rectification.

**CHAMPION**, 43, Uplands Way, London, N.21. Tel. Lab. 4457. [6475]

**RADIO CLEARANCE, Ltd.**, 27, Tottenham Court Rd., W.1. Museum 9188.

**MAINS** trans, 350.0-350V 80mA, 6.3v 3a, 5v 2a, 21/-; speakers, P.M., all well-known makes, 2 1/2in 25/-, 3 1/2in 25/-, 8in with trans 30/-, 8in less trans 25/-, 10in with trans 42/6; energised Bin. 2.0000 field, 25/-; tuning condensers, 2-gang, 0.00035, short spindle 6/11, 0.0005 3-gang, 7/6; volume controls, with switch, 10K, 50K, 250K, 500K, 4/6; 2-watt switch, 10K, 20K, 50K, 100K, 500K, 2M, 2/6; miniature 1K, 20K, 100K, 200K, 500K, 2/-; wirewound 3w, 100Ω, 200Ω, 500Ω, 1K, 2K, 3K, 5K, 10K, 20K, 2/6; electrolytics, 8mf 50v, cam 3/3, cardboard wire-wound, 500v 3/-, 4mf 200v micro 2/-, 25mf 25v cam, 20mf 50v or 40mf 12v 1/9; Mansbridge conds, 1mf 350v 9d, 2mf 450v 1/6, 4mf 1,500v 5/-, 1mf 1,000v, 1/3; switches, 1p 3w 1/9, 1p 12w 3/-; condensers, tubular, 0.001, 0.002, 0.005, 0.01, 0.02, 0.05, 6d; 0.1 350v 7d, 500v 9d; condensers, mica, 0.0001, 2, 3, 5, 4d, 0.001, 2, 5, 5d, 0.01 6d; resistors, 1/4w 3d, 1/2w 4d, 1w 6d, 2w 10d, 3w 1/3, all values; 3w wirewound, 470Ω, 3.9K, 6.8K, 47K, 1/-; vitreous 20w, with clips, 120Ω, 200Ω, 2K, 8K, 2/-; silver mica conds., 2,500 pf, 6d; ceramic 12v 10 50 100 pf, 6d; 1 F's 465 kc/s, iron core, 12/- pair; television line trans, 12/-; Bakrolised tubular condensers, 0.17 250v 3d, 0.5 400v 6d, 100mfd 12v elect, 1/-; Ally chassis, 10 1/2in x 10 1/2in x 2 1/2in, part drilled, 3/6; ceramic trimmers, 3-50 pf, 1-15 pf, 9d; padders, 600 pf, 1/-; mains droppers with 2 sliders, 0.2a 1,000Ω 3/3, 800Ω 0.3a 4/- h.t. chokes, 1.7v valveholders, 4-pin, 4-pin, 1d; amp H, UX, 4-pin, Brit. 5-pin, Mazda or int. octal, 6d; ceramic valveholders, UX 5-pin, UX 7-pin, E.F.50, 1/6; selenium rectifiers, 250v 60mA H.W., 6/6; flat P.O. type 10w res, 1K, 2K, 4K, 1/-—Radio Clearance, Ltd. [6503]

**JACK PORTER, Ltd. (RADIO)**, sends you for 5d in stamps, 1946-7 complete catalogue.—College St., Worcester. [6499]

**A** MATFUR surplus gear for disposal, including meters, valves, 9000 series, acorns, 807 and others, valve tester, Cosor D.B. oscilloscope, R.C.A. receiver, AR88, recording outfit; please send s.a.e. for detail list. Box 2691. [6148]

# GALPINS

GOVT. SURPLUS ELECTRICAL STORES

408 High St., Lewisham, London, S.E.13

Telephone: Lee Green 0302. Near Lewisham Hospitals

TERMS: CASH WITH ORDER, NO C.O.D.

"WESTON" Moving Coil Meters, edge type.

2 1/2in. scale, 0 to 3 amps, 30/-; 0 to 2 amps, 27/6, 0 to 60 volts, 27/6; 0 to 150 volts, 27/6, all have F.S.D. of 2 m/amps; 0 to 1 volt, 1 m/a. F.S.D., 35/-; another 3 1/2in. scale reading decibels 50 microamps, F.S.D., 70/-, another 301 model 0 to 3 m/a., 40/-; 0 to 50 m/a., 35/-; 0 to 200 m/a., 35/-.

**ELECTRIC LIGHT CHECK-METERS**, guaranteed electrically, 200/250 volts 50 cy., 1 phase, input 5 amp. type, 12/6; 10 amp. type, 15/- each. Carriage 1/-.

**ERNEST TURNER**, moving coil m/amp. meters 2in. scale, 0 to 10 m/a., 0 to 20 m/a., 0 to 50 m/a., 27/6 each; all fully guaranteed. Standard Telephone 3in. scale m/coil meters, calibrated to read 0 to 25, 100 volts movement, 1 m/a., incorporating metal rectifier, 45/- each.

**EX.-G.P.O. MAGNETO GENERATORS**, hand-driven, approx. output 75 volts 20mamps. A.C., useful to the experimenter, small pattern, 7/6 each.

**USEFUL PANELS** made by Standard Telephone for the R.A.F., size approx. 19in. x 8in. x 5in. consisting of condensers calibrated to decibels, chokes, mod. Xformers, resistances and many other useful components, condition new, 12/6 each, post 2/6.

**VOLTAGE CHANGER TRANSFORMERS**. Auto-wound, fully guaranteed, immediate delivery. 350 watts, 55/-; 500 watts, 70/-; 1,000 watts, 85/-; 2,000 watts, 115/-. All tapped 0, 110, 200, 220 and 240 volts.

**TRANSFORMERS BY WELL-KNOWN MAKERS**, input 200/250 volts 50 cy. 1 phase output 1,500 volts at 3 Kilowatts twice, £12 10s. each. Voltage Regulation Transformer only type 200/250 volts 50 cy. 1 phase, £15 each, new condition.

**MAINS TRANSFORMERS**, all by well-known makers and fully guaranteed, input 200/250 volts, 50 cy. 1 phase; output 2,000/0/2,000 volts at 250 m/amps with 2 L.T. tapplings, 75/-; Ditto, 475/0/475 volts at 150 m/amps, with 3 L.T. tapplings, 4v. and 6v. price 42/6. Ditto, 800, 100 120, 140, 200, 220, 240 volts at 3,000 watts, £12 10s. Ditto, 6, 16 volts at 14,900 amps output, £15. Transformer cores, suitable for winding 2,000 watts, 27/6; 100 watts, 7/6 each.

**EX.-R.A.F. 10-VALVE CHASSIS** (sold for components only). Consisting of: 2, 150 ohm Mult. Contact Relays, 9 British type Octal Base Valve Holders, 30 Tubular Condensers, ranging from 10 P.F. to 1 M.F. 25/30 Resistances 1/2, 1 and 2 watts all mounted on chassis, size 12in. x 8in. x 2in. Components all in good condition. "A real bargain" at 12/6 each, postage 1/6.

**EX-GOVT. ROTARY CONVERTERS**, input 12 to 18 volts D.C. at 3 1/2 amps. output 450 volts 60 m/amps. fitted with automatic switching and smoothing, 32/6 each. 2/6 carriage.

**BALLAST LAMPS (GOOD MAKERS)**, new 125 volt 30 watts E.S. fitting, 6/- per dozen.

**EX-G.P.O. PRE-UNISELECTORS**, 3 ohm automatic relay operating a 4-way Yaxley switch, fitted with 2 condensers .01, 1 1/2 M.F., new, boxed, 5/- each. G.P.O. Polarised Telegraph Sounders in new condition, 15/- each. G.P.O. Polarised Relays, operating on 10/20 m/amps. coil resistance, 230 ohms, 15/- each, as new.

**SHORT WAVE H.F. CHOKES 1/6**: H.F. chokes, 1/; 01 condensers, 4/- per doz. R.1 2 to 1 L.F. transformers, 6/-; condensers, 1 M.F. 1/3; 2 M.F. 2/-; 4 M.F. 3/-; 10 M.F., 5/6 each; smoothing chokes, 20/30 henrys, 80/100 m/amps, 8/6; electrolytic condensers, 80 MF 350 v. wkg., 7/6; 500 MF 50 v. wkg., 8/6.

**ELECTRODYNAMIC D.C. TO A.C. ROTARY CONVERTERS**. Complete with smoothing in Silence Cabinets. 200 volts D.C. to 230 volts A.C. at 120 watts, £13/10/-. Ditto, 200 watts, £16/10/-. Carriage paid.

**PUBLIC ADDRESS RIBBON MICROPHONES**, by well-known makers, £3/10/- each. "STEEL RACKS" useful as xmitter rack. Size: 40in. x 24in. x 16in., 30/-; Ditto, 58in. x 19in. x 12in., 50/-; Ditto, 58in. x 33in. x 18in., 70/-; Carriage 7/6 on all types.

**ENGINEER**, going abroad, must sell large collection of radio apparatus, including instruments, loudspeakers, microphones, components of all types.—Send for list, Box 1214.

**ALUMINIUM** chassis, panels, cabinets. A LUMINOR for the amateur by precision engineers; trade enquiries invited; s.a.e. lists.—G.L.G. Radio, Morchard Bishop, Nr. Crediton.

**W**EE megger, 500volt, in leather case, almost new, £8; Davenset charger, 30volt 6amp, as new, £9/10; Vortexion amplifier, 15 watts 12v 230 A.C. new valves, £14.—Pearce, 66, Great Percy St., W.C.1. [6328]

**ALUMINIUM** sheet, panels, chassis, cabinets, racks, plain or cracked, complete equipment, components, metal valves, etc.; s.a.e. lists.—Amateur Radio Service G6HP, Canning St., Burnley. [6221]

**SELECT RADIO** 151, Ley St., Ilford, Essex, heavy duty, £65.—Make your servicing pay better. We only sell what we know will do the job. Send for list 1/6d or call.

**VALVE** holders, U.S. or Mazda Octal, 4/- doz; droppers, 3 with fixing feet 3/9, 2 4/-; line cord, 3-way, 60Ω per ft, 15/- doz yds; connecting wire 1/2 reel, 2/-; 1lb reel solder, 4/3; toggle switches S.P.S.T., 24/- doz.

**CARDBOARD** condensers wire ends 8 mfd, 30/- doz, .1 500v working 4/- doz, 01 5/- doz, 05 6/- doz; carbon resistances, 1/2-1 watt, assorted, as used every day, 3/- doz.

**TWIN** gang condensers .0005 with fixing feet, best quality, 11/-; midget chokes, 60 mills, 6/-; heavy duty, 9/-; mains transformers from 15/-.

**SPEAKERS**, all sizes, prices, on application; also Airmaster radio in console, table model, or chassis; large stock of valves, and many other lines for trade. Clearance lines: Ruliber bushes 1in x 1/2in 1/4 hole, 4d doz.; carbon motor brush springs, 2d doz.

S.A.E. all enquiries, no c.o.d. Send 6d extra postage all orders under £5. [6502]

**COULPHONE RADIO**, Station Rd., New Longton, Nr. Preston.—The return of Post Mail Order Service. New goods only C.O.D. or cash with order. Orders over 5/- note prices.

**EDDYSTONE Model 504** communications receiver. Rotational deliveries now commenced. SW Manual 2/6.

**ALL** Tunggram and B.V.A. valves: list prices. WYEMOUTH 3W.B. superhet coil packs, 38/6. Midget iron cored I.F.T.s, 465 kc/s, matched pr., 17/6. 0.0005 two gangs with 2-speed drive, 16/6.

**LINE** Cord 3 amp, 60Ω per foot, 2-way 1/6 yd., 3-way 1/9 yd.; mains droppers, Feet, 2 sliders, 2 amp 4/3, 3 amp 4/6.

**GOODMANS** 02/1205/15 12in P.M. quality G.P.O. speakers, £6/15; Metron 3mheyer quality 8-valve gram amplifiers, £22/10; battery chargers 6 and 12v at 3 amp, £6; Plessey 8in P.M. speakers, 10,000 lines, with pentode trans., 29/6; T.R.F. tuning coils, M. & L., with reaction, A. and H.F., 9/6 pair; superhet coils, Ae. and Osc., S.M.L., 11/6 pair; "P" type coils, all types, 2/6 each; aluminium chassis, 4 sides, 16 gauge, 3in deep, 10in x 8in 5/6, 12in x 9in 9/6, 14in x 9in 10/6, 16in x 8in 10/6, 20in x 8in 12/6; Pyrobit instrument soldering irons, 21/-.

**MAINS** transformers, highest quality, primaries tapped, 200/250 volts, 300/0/300, 60 m.a. 4v 3a, 4v 2a or 6.3v 2a, 5v 2a, 17/6; 350/0/350 100 m.a., 4v 6a, 4v 2.5a or 6.3v 3a, 5v 2a, 24/-; bobbins 15/6; 450/0/450 200 m.a., 4v 8a, 4v 4a, 4v 4a or 6.3v 4a, 6.3v 4a, 5v 3a, 42/6; or 6.3v 6a, 4v 2a, 4v 2a, 5v 3a, 45/-.

**EDDYSTONE** shortwave components. BPL Test Sets, 17 range, latest type, £8/8/6. TUNING units, model A3, R.F. stage, 16/50, 200/550, 800/2,000, completely assembled and aligned with 3-gang condenser, drive scale and escutcheon, £25/15; model B3 as above, but with I.F. stage and D.D. stage, £8/15.

**SEND** 2d stamp for new 16-page catalogue.

**SURPLUS** Wire.—Rubber and rubber cotton covered flexes, screened flexes; one to six core insulated bell wires and many others; list and prices.—Mc B. Heat Control, Ltd., Mill St., Harlow Common, Essex. [6485]

**RADIO** and electrical components, astounding offer of Govt. surplus condensers.

**T.C.C. Sprague & Solar**, all brand new & boxed, for sale in quantities only.—Hadley Sound Equipments, 587, Bearwood Rd., Smethwick.

**BIG** display of Government surplus material offered at fraction of original cost.—Central showrooms situated top of Tottenham Ct. Rd., Norn an Rose, Norman House, 53, Hampstead Rd., London, N.W.1. Bus 686-2, 6013

**RADIOGRAPHIC, Ltd.** (B.R.S. 12040), of Glasgow are forging ahead in getting supplies of vital interest to all radio enthusiasts; keep in constant touch for the latest news of still greater supplies.

**TRANSMITTERS**, transceivers, valves (RX and TX), and all components. **RADIOGRAPHIC, Ltd.**, 66, Osborne St., Glasgow, C.5. [5516]

**LASKY'S RADIO**

**XMAS SPECIALS**

All Orders Post Free.

.0005 MIDGET TYPE 2-GANG CONDENSERS, less trimmers, 10/6 each. HIGH-GRADE POSTAGE STAMP TRIMMERS, 50 P.P., 7/6 doz., 9d. each. 5" MOVING COIL SPEAKERS, 2 M., 21/6 each. 8" MOVING COIL SPEAKERS, P.M., 21/- each. WEARITE "P" COILS, most types, 3/- each. A.E., OSC and H.F. All waves. WEARITE I.F. TRANSFORMERS, 465 Kc/s, 10/- each. WEARITE MIDGET I.F. TRANSFORMERS, 465 Kc/s, 10/6 each. LONG AND MEDIUM WAVE COILS, T.R.F., with reaction, circuit included high gain, 8/6 per pair. CARBON AND WIREWOUND POTMETERS, all values, 3/3 and 3/6. CARBON POTMETERS, with switch, all values, 5/-. TELESCOPIC CAR RADIO AERIALS, 4 sections, 8ft., as used on army staff cars, complete with screened lead-in cable. Brand new, 25/- each. THE VERY LATEST "PICOPACK" Midget Bias CONDENSERS, 10 mfd. 26 volts working, 2/6 each; 20 mfd. 12 volts working, 2/6 each. MIDGET TYPE ELECTROLYTIC CONDENSERS, 500 volt working: 8 mfd., 3/-; 16 mfd., 4/6; 8-8 mfd., 5/6. BIAS CONDENSERS ELECTROLYTIC: 25 mfd. 25 volts working, 1/9 each. 75 mfd. 12 volts working, 1/6 each. HIGH VOLTAGE CONDENSERS, 1 mfd. 8,000 volts working, 10/- each. EX GOVERNMENT GROUP BOARDS, complete with brackets, wired up, consisting of Resistances and Condensers: No. 1.—41" x 3", two 1 mfd. 500 v.w., two 5,600 ohms 5 watt, four 1-watt resistances. No. 2.—8" x 3" two 3-watt resistances, four 1-watt, three 1-watt, one .005 mfd. 1,000 v.w. No. 1, 2/6 each; No. 2, 2/6 each. Large stock of all radio components, Mains Transformers, Chokes, Output Transformers, Radio Valves, Coils, Condensers, Resistances, etc., etc. All goods sold by us carry our unconditional guarantee. Satisfaction or money refunded. Send 1d. for Current List and Bulletin. TERMS: Cash with order. C.O.D. Pro-forma. No C.O.D. under £1.

**LASKY'S RADIO**  
370, Harrow Road, Paddington, W.9  
(Opp. Paddington Hospital) Phone: Cunningham 1973

G. A. RYALL, 65, Nightingale Lane, London, S.W.12.—Mail order only; no c.o.d. under £1, please; postages extra; retailers, set manufacturers, those engaged in radio service work, are invited to send for our Special List.

U.S.A. make 0.1mf 500v tubular metal cased condensers, 5/- dozen; 0.5mf, 3 2/-; 0.002 tubular wax dipped 450v 3/6 doz.; resistances, best British makes, 1/2-watt, sizes 82, 220, 270, 500, 1,000, 2,200, 4,000, 50,000 1.5meg, 2.5 meg, 3/- doz.; also good assortment 1/4-watt, 1/2-watt, 1-watt, 20 sizes from 100 to 2 meg, 1/6 doz.; best makes carbon 2-watt resistances, 6,800, 36,000, 43,000, 140,000, 150,000, 220,000, 470,000, 82,000, 4/- doz.; also 3-watt 33,000, 3 1/6, or 4/- doz.; 1,800 wire-wound, 1-watt, 1/- doz.; non-insulated, 2,000-ohm carbon, 1/- doz.; vitreous 20-watt, 4,700 ohms, 2/- each; panels with screened 0.1mf and 12 1/2-watt resistances, 2/3 ea; panels with pairs of 0.1mf 530v condenser wax dipped, 4/- per 6 pairs; twin trimmers, 30mm on bar, separate, 3 2/-; Octal plugs with metal caps, with chassis-type sockets, 3 2/6; with solder tags, 3 3/-; valveholders, British 7-pin, U.S.A. 4-, 5-, 6-pin, all 4/- doz.; volume controls, less switches, 1 meg short spindle, 1/6; 1/4 meg bakelite cased, slotted for pre-set, 1/6; 1/4 meg, metal cased, 1/6; Yaxley type switches, single bank short spindle, 9-way, 2/3; three-bank 4-way 2-pole, with middle screen, 3/9; post. di on singles; double phone and mike transformers, secondarys 175.45.10 ohms, 5/- each; power microphones, unused, work direct into loudspeaker, 20/- each; a few single type control boxes available, containing 2 Yaxley switches and distribution blocks, etc., new, 2/6 each; C.O.D. only this line. [6438]

CLEARANCE sale, volume controls 20K, 50K, 100K, 500K, 5 meg 1/5 each; for 6/-; 1/2-watt resistors, 2/- dozen; 0.1mf 500v block condensers, 1/6; 4mf 25v block, 1/6; add postage.—M. O. S., 24, New Rd., London, E.1. [6381]

VORTEXION transformers and chokes, etc., supplied to B.E.C., G.P.O., L.P.T.B.; why not you? wound to any specification; imitated but unequalled.—Vortexion, Ltd., 257-261, The Broadway, Wimbledon, S.W.19. [4536]

OSMOR Radio Heart equals complete first class 5-valve superhet, positively only small condensers and resistances to find, super efficient components, building instructions; £5/16; cabinets; trade invited.—Morgan Osborne, Ltd., Southview Rd., Upper Warringham 2560, Surrey. [6226]

COILS, high gain t.r.f. combined med. and long wave, 2 3/4 in long, a really first-class job; aerial and h.f. 7/- pair post paid, 2-colour station scale, 1 3/- Aneloy Radio (new and spacious showrooms), 15, Upland Rd., E. Dulwich, London, S.E.22. [6301]

"OSMOR" Radio Heater, the basis of a first-class 3-wave superhet, includes everything except easily obtained small condensers and resistances; £5/16, cabinets, 48/-.—Ask your dealer, or Morgan, Osborne, Ltd., Southview Rd., Warringham, Surrey. Up. Warringham 2560. [6349]

THE last word in radio kits! Really detailed instructional manuscript how to build best type of 4v A.C./D.C. receiver, 2/6; complete kit incl. valves and super cabinet, £8; all standard radio components supplied by return c.o.d. Our aim is a new, higher standard of service.

NORTHERN RADIO SERVICES, 66, Parkhill Rd., London, N.W.3. Gulliver 1453. [6326]

100 cases of German make telephone equipment, comprising 20 small changes, and 80 cases of associated equipment, including telematic dials, interconnecting cables, termination boards, relays, etc., all new and unused, original estimated cost about £2,500; price £350 the lot, including cases value £150.—Apply Pearson, 263, Gallowgate, Glasgow. [6223]

MAINS transformers, first grade and brand new, still the finest value in the trade; 350-0-350 80mA, 4v 4a and 4v 2.5a, or 6.3v 3a and 5v 2a, 22/6, post 1/-; 120mA type, 6.3v tapped, 4v and 5v tapped 4v, 27/6, post 1/- Similar quality 30w output, multi-ratio 20/-, post 1/-; s.a.e. for list of other bargains.—Aneloy Radio (new and spacious showrooms), 15, Upland Rd., E. Dulwich, London, S.E.22. [6301]

COMPLETE kit of parts for 4v T.R.F. receiver, medium and long wave, 200-250v A.C./D.C. operation; includes polished aluminium chassis fully drilled, 5in speaker. Wearite coils, valves 6K7, 6J7, 25A6, 25Y5, S.M. drive, illuminated coloured ivory dial, wire, systonex, and absolutely everything required to last nut; circuit supplied £6/10; polished wood (walnut) cabinet to suit, size 11 3/4-7 1/4-6 1/2 in... 25/- extra; terms c.w.o. or c.o.d.—E. Powell, 19, Lidget Hill, Pudsey, Leeds. [6318]

**AMERICAN PUBLICATIONS**

Order your American Technical Books through us.

All books and magazines are posted direct from the United States with the minimum of delay.

INTRODUCTION TO MICRO-WAVES ..... 12/6  
ELECTRONS IN ACTION .... 16/6  
RADIOMAN'S HANDBOOK .. 16/3  
COYNE'S "ELECTRONICS" .. 25/-  
ELECTRICIAN'S HANDBOOK 13/9  
AMATEUR CALL BOOK MAGAZINE (latest issue) .... 8/9

(All prices include postage)

Special:—

"RADIO MAINTENANCE MAGAZINE"  
Published Monthly. Subs.: 17/6 per year.

THE RADIO HANDBOOK  
Radio's outstanding practical book for Amateurs, etc. How-to-Build-it descriptions of dozens of Transmitters, Receivers, and Test Equipment. 700 pages, cloth bound 12/

Send cash with order to:

**DALE ELECTRONICS LTD.**  
105, Bolsover St., London, W.1.  
Telephone: MUSEum 1023.

**. YOU can become a first-class RADIO ENGINEER**

We are specialists in Home-Study Tuition in Radio, Television and Mathematics. Post coupon now for free booklet and learn how you can qualify for well-paid employment or profitable spare-time work.

**T. & C. RADIO COLLEGE**  
North Road, Parkstone, Dorset

(Post in unsealed envelope, 1d. stamp)  
Please send me free details of your Home-Study Mathematics and Radio courses.  
NAME .....  
ADDRESS .....  
W.W.64

**RELIANCE POTENTIOMETERS**

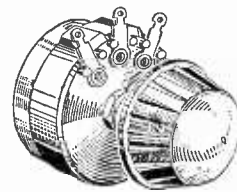

**TYPE T.W.**  
Continuous Wire-Wound (as illustrated)  
Rating: 5 watts (linear)  
3 watts (graded)  
Ranges: 10-100,000 Ω linear Max  
100-50,000 Ω graded ..  
100-10,000 Ω Non-Inductive  
Characteristics: Linear, tapered, graded, log., semi-log. inverse log., non-inductive, etc.

Write for full details to:  
**RELIANCE**  
Manufacturing Co. (Southwark) Ltd.  
Sutherland Road, Higham Hill, Walthamstow, E. 17  
Telephone: Larkswood 3245



**S**ANGAMO synchronous motors, self-starting, exceptionally good torque, rotor speed 200 r.p.m., 200-250v ac, 50c, consumption 2½ watts, size 2¼x2, geared 1 rev 60 min, can be reset to zero by friction drive from front or back, shaft ⅝in x 1/10, to run clockwise, ideal movements for making electric clocks, time switches, etc., nickel plated finish, price 22/6 each.

**M**AKE your own dark room clock.—Sangamo synchronous motor, self-starting, 200-250 ac, 50c, geared 1 rev. 60 seconds, can be reset to zero by friction drive from front or back, shaft ⅝in x 1/10, to run clockwise; 22/6 each.

**15AMP** mercury switches, enclosed bakelite tubular cases, 2½in x ¾in, fitted swivel saddle, connector block, etc., 5/6 each.

**CASH** with order post paid on all above goods.

**TO callers only.**—A comprehensive stock of scientific instruments, meters, gears, relays. SANGAMO synchronous motors, size 2¼x2in. price incorrectly printed as 2/6 each, instead of 16/6 each in November issue, also the Chamberlain & Hookham motors should have been described as 1 rev 60 min, not 1 rev 6 min.

**FRANKS**, Scientific Stores, 58, New Oxford St., London, W.C.1. Tel. Mincut 9594.

**I**MMEDIATE delivery of the Summersby I.F. transformers, permeability tuned, Litz wound, high Q, a high grade for only 15/- per pair; a stamped addressed envelope will bring you the Weymouth circuit, complete constructional diagrams for the high fidelity receiver 2/6, coil pack 38/6, 3-wave dials 3/6, 2-speed 2-gang 0.0005 condensers 17/6; all components stocked.—Castle Radio, 101, Poverest Rd., Orpington, Kent. [6439]

**EX-GOVERNMENT** bargains; engineers' 12in combination sets, 37/6; 2-speed breast drills, takes ½ drill, 27/6; steel squares, 6in, 2/6; ditto, 4 in, 2/-; outside spring adjustable calipers, 1/6; 10in sheet metal cutting snips, 3/6; good engineers ¼in jaw workshop vices, 27/6; aluminium rivets, round and countersunk, useful parcel approx 12 gross, 6/-; 24 gross ditto, 10/-, assorted sizes.—Ilughes & Sons, 28, Clarence Place, Newport, Mon.

**COILS** of the future here today; A. Summersby, designer and originator of the Weymouth coil pack, I.F. transformers, etc., has now produced the most amazing coil pack yet offered to the constructor; totally permeability tuned, no variable condenser needed, flywheel tuning, coils have a terrific gain; the Summersby I.F. transformers, 465 kc/s, Litz wound, high Q, permeability tuned, can be purchased now from your dealer. [6429]

**ELECTROLYTICS** 500v working, 8mfd 2/10, 1/8x8mfd 5/6, 16mfd 4/9; mains transformers 500-0-500, 200ma, 6.3v 4a, 6.3v 2½a, 5v 5a, 45/-; 350-0-350, 80ma, 6.3v 3a, 5v 2½a, 4v 4a, 4v 2½a, 32/6; vibrator transformer 2v input 180v output, L.T. and G.B., easily adaptable for any use, with 2 accumulators, 4/-; 102in telescopic aerials, 17/6; ex-R.A.F. "Identification Friend or Foe" receiving and transmitting units, complete with valves and containing components worth over £20, a few only 75/-; s.a.e. for component list.—E.L. Corp., 32, St. Gabriel's Rd., London, N.W.2. [6296]

**ROTARY** transformers, brand new, ex-Govt. stock, with 6v input, output 200v at 50ma continuous, or 150v at 80ma up to 3 hours, with 12v input, output 480v at 40ma continuous or 400v at 80ma up to 3 hours, size, length 7½in, height 3¾in, weight 6¼lb, original price £7/7, each 25/-; midget m.v. wave t.r.f. coils, high gain, 5/-; m.l. wave, with reaction, circuit, 7/6; m.l. wave, iron cored, adjustable cores, circuit, 10/6; s.m.l. per. and osc. coils, circuit, 10/6; Weymouth midget i.f.s., iron core, 465kc/s, per pr., 19/6; standard i.f.s., 465kc/s, per pr., 15/-; Weymouth all-wave coil pack, 38/6; coloured ivorine dials, s.m.l. wave, 4x3½in, 2/-; 5x5½in, 2/6; slow motion drum drive, 3/-; epicycle drives, 3/3; square plane drive assembly, complete with station named dial, 4½x3¼in, m.l. wave, pointer, glass, escutcheon, etc., 11/6; miniature rotary switches, 4p 3w, 4/-; tubes, midget 50ma, 5/6; standard 80ma, 8/6; heavy 150ma, 12/6; Simplex chassis, 11p 4½x2in, at 6/-; W5V chassis for coil packs, 11½x5½x2½in, at 6/6; all chassis with 6in speaker cut-out and fully drilled all component holes; nuts-screws, 6 BA, 4 BA, per gross (2 gross in all), 6/-; heavy duty output P.P. trans, 6.600, A to A load, tapped output, 7.5 and 15ohms, each 21/-; Stanelco soldering irons, 250-50v, list 22/6, at 19/6; monthly comprehensive lists, well worth having, 2/6d post, postage all orders.

**G. GREENLICK** Ltd., 34, Bancroft Rd., Cambridge Heath Rd., London, E.1. Tel. Stepney Green 1334. [6463]

# ARMSTRONG

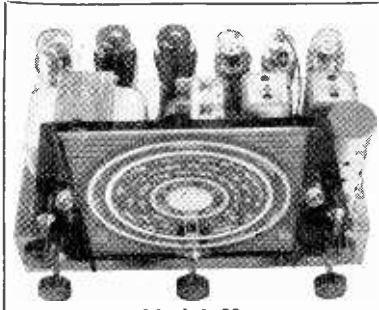

Model 83

As announced last month, we have developed an 8-valve Universal Chassis on the lines of our now popular EXP83. This was in response to many requests for a good quality receiver for use on either D.C. or A.C. mains. This new chassis is our

## Model UNI-83

**ALL-WAVE 8-VALVE SUPERHET CHASSIS** incorporating wave band expansion, e.g. the 16-50 m. band covers just over 20 inches on the large glass scale, treble boost control, gram switching, all controls work on both radio and gram, high quality push-pull output giving 6 watts audio. For 200-250 v. D.C. or A.C. mains.

Provisional Price 14 gns. plus tax

## Model EXP83

**ALL-WAVE 8-VALVE SUPERHET CHASSIS** incorporating wave band expansion. Large glass scale treble boost control. Gram. switching. High quality push-pull output gives 10 watts audio. For 100-250 v. A.C. mains.

Price 14 gns. plus tax.

## Model EXP53

**ALL-WAVE 7-STAGE RADIOGRAM CHASSIS** This new radiogram chassis incorporates wave-band expansion on all bands. Volume and tone controls work on both Radio and Gram. 4½ watts R.C. coupled output. Supplied complete with full size loudspeaker. This chassis has a lively performance, good quality reproduction, and represents excellent value. For 200-250 v. A.C. mains.

Price, with speaker £13 plus tax.

## Model EXP43

**ALL-WAVE SUPERHET FEEDER UNIT** incorporating wave band expansion manual I.F. gain control, etc.

Price 11 gns. plus tax.

● We very much regret that, owing to the continual rise in cost of materials, it may be necessary to increase the above prices slightly by the time this advertisement appears.

Demonstration Sets are now available for interested callers to hear and illustrated technical specifications are now ready.

**ARMSTRONG WIRELESS & TELEVISION CO. LTD.**  
 WARLTERS ROAD, HOLLOWAY, LONDON, N.  
 Phone: NORth 3213

**T**ELEVISION components.—Gardner's mains transformer, 1,500-0-1,500v, 20ma, 4-4-2v, 3kv insl., 70/-; 0.5mfd 3,000v condensers, 6/6 ea.; 0.1mfd 2,500v, 0.01mfd 5,000v, 4/- each; high voltage rectifiers, SU21 50a 5kv at 5ma, 20/-; V1907, 5kv at 50ma, 25/-; oscilloscope tubes, 1½ inch 25/-, 3 inch 35/-; 100 microamp. F.S.D. 3½ inch dia., MC meter, 50/-; 6L6s (metal), 12/6 ea.; 500v wet megger, £5; all guaranteed in good condition, valves new; post paid.—Box 4337. [6444]

**T**RANSFORMERS for every purpose, highest grade workmanship, competitive prices, immediate delivery; microphone, intervalve and P.P. driver trans, O.P. trans, 1 to 60 watts; chokes, all sizes, fluorescent light chokes; mains trans to 2kva auto-trans, 60va to 2kva (200-250v, 115v and 24v at max. current); test gear trans for bridges, oscilloscope valve testers, etc.; list 1d.—Radio Services, Field St. Works Blackpool. Tel. 1250 15602

**G**EE ELECTRIC, 15, Little Newport St. London, W.C.2.—A few of the many lines we can quote from stock; med. and long t.r.f. coils with diagram, 7/6 per pair; 0.0005 3-gang tuning condensers, 2in x ¾in spindle, 8/6 each; 465 kc/s I.F.s., 3½x1½x1½, 15/-; the best pair at the price; English and American valves always in stock; high voltage paper condensers and similar tubular condensers and many other lines; keenest prices quoted for trade quantities; send 1d. stamp for list.

**Q**UANTAL valve holders, 1/-; plus grid and jack, 4/9; valve screens, 1/6; ceramic int. octal valve holders, 1/9; superhet coils 11/6 pair; single coils, similar to P type aerial, oscillator and h.f. l, m and s, at 2/10 each; Ultra midget tuning condensers, twin 0.00035 15/-, 3-gang 0.0005 9/-, 4-gang 0.0005 8/-; trimmers, 50pf 9d., 250 pf 1/6, 300pf 1/3, 500pf 1/9, 750pf 2/3; midget speakers, 2½in 27/6, 5in, 6½in and 8in 25/-, all less trans.; midget i.f. trans., 465kc/s. 1in x 1in x 2in, 15/6 pr. This represents only a small selection from our stock; please send 2d. for complete list.—R. S. Robinson, Esq., 6227 Darlington, Co. Durham.

**C**HARLES AMPLIFIERS have pleasure in announcing the opening of their new premises; customers old and new will be welcome to try our famous amplifiers of exceptionally high fidelity and tuning unit; the latest in high fidelity speakers, decorative baffles and equipment and latest records; blue prints of our 3 and 7 watts cathode follower amplifiers, which are meeting with an extraordinarily enthusiastic response, and our new extra tuning unit, which is both an all-wave superhet and a high fidelity t.r.f. unit; prints, with full size point-to-point wiring diagrams, 2/6 each, 5/- the set of three; complete kits or separate components supplied; stamp for details.—Charles Amplifiers, 1c, Palace Gate, Kensington, London, W.8 (one minute from the Albert Hall). [3449]

**F**EWKICK for aluminium panels, 18in x 8in, 14 gauge 4/-, 18in x 12in 4/6, 18in x 8in 3/-, 18in x 6in 2/6, 18 gauge, post paid. Speaker gauze, 6in sq. 1/3, 12in 2/9, 18in 4/3, Bepex 18in x 13½in x ¾in 21/-, or half size 10/6. Westinghouse instrument rectifiers 1 or 5ma 10/6, also H.T. and L.T. units. Weymouth A/wave 8/H coil packs 38/6, or coils only 11/6 pr., miniature I.F.s, 465 kc/s. 19/6 pr., M/L TRF coils with reaction 9/6 pr., circuits included, postage 6d. extra; J.B. 0.0005 twin gang 13/6. Huge stocks of valves, enquiries invited. Eddystone appointed agents. Pickups, transformers, chokes, mikes, linecord, speakers, 2½in to 12in; we carry the largest and most varied stocks of components in the Midlands. Circuits 8d. each, 2v A.C., 5v A.C. S/H, multitrance testmeter. Radio Reference Handbook, 13/-. Whatever your radio requirements write to Fenwick, Dept. P., Gt. Brickkiln St., and Snowhill, Wolverhampton. [6241]

**T**ELERADIO New Coil Pack.—Easing of export commitments enables us to offer home constructors the coil pack and accessories used in one model. A full scale practical and theoretical set of drawings have been prepared around the units, making it a simple matter to construct really high gain all wave superhet radiogram chassis, up to commercial standards. A rust proof fully drilled chassis made specially for the export model is offered with the coil pack. Prices are reasonable. Chassis with 5 amphenol valve holders and A.E. and P.U. sockets, all riveted in position, size 13½x5½x2½, 10/6 plus post; coil pack with circuit, 22/6 plus post; coil pack with chassis, I.F.s and full blueprints, 70/- plus post; blueprints and list of parts are supplied separately at 5/-. Note.—All inductances are supplied ready aligned and calibrated to special dial available and no trimming is therefore necessary. Send stamp for any further details. Initial deliveries limited. TELERADIO (Dept. S.P.), 157, Fore St., N.18. [6338]

• HENRY'S •

THE FOLLOWING ARE A FEW ITEMS FROM OUR COMPREHENSIVE STOCKS OF GUARANTEED RADIO COMPONENTS

T.C.C. PICOPACKS. 20 mfd. 12 v. wkg., 10 mfd. 25 v. wkg., 2 mfd. 150 v. wkg., at 2/6 ea.

TUB. AND CAN. ELECTROLYTICS. 8 mfd. 500 v. wkg. 3/-, 8 mfd. 200 v. wkg. 2/-, 8 mfd. 150 v. wkg. 2/-, 16 mfd. 500 v. wkg. 4/-, 8 x 3,500 v. wkg. 6/-, 8 x 4,500 v. wkg. 5/-, 500 mfd. 12 v. wkg. 5/-.

BLOCK AND OIL FILLED CONDENSERS. 4 mfd. 1,000 v. wkg. 7/6, 1 mfd. 1,000 v. wkg. 3/-, 1 mfd. 750 v. wkg. 2/-, 2 mfd. 1,200 v. wkg. 5/-, 4 mfd. 450 v. wkg. 4/-, 8 x 4,450 v. wkg. 5/-, 16 mfd. 300 v. wkg. 3/-, 16 mfd. 700 v. wkg. 7/6, .02. 8,000 v. wkg. 7/6, .03. 3,000 v. wkg. 4/6.

CAR RADIO COMPONENTS. Vibrators 6 and 12 volt 4 pin 9/6. Vibrator Trans. 6 volt only, 15/-, Telescopic Aerials Canadian 4 section with screened lead, 25/-, 6 volt Car Radio Supply Unit, output 200 v., 60 ma. Completely smoothed, £3/15-. Voltage droppers, 12 to 6 volts, 7/8.

COILS. T.R.F. M. and L. wave with reaction, 8/8 per pr. T.R.F. Med. only, 5/8 pr. Three-wave band with Osc. colls. 9/6. I.F. Trans. 465 K/C's, 15/- pr. I.F. Trans. 110 K/C's, 12/6 pr. Osc. Colls. 465 K/C's Med. or Long, 2/9 each.

P.M. SPEAKERS. 5in. less trans., 19/- 8in. with trans., 27/6.

CASH WITH ORDER. OR C.O.D. (OVER £1)

SEND STAMP FOR 1947 PRICE LIST

• TRADE ENQUIRIES INVITED •

HENRY'S RADIO

5, HARROW RD., EDGWARE RD., W.2

PAddington 2194



WE APOLOGISE to those who have been waiting months for replies. Our post-war plans have been frustrated so far. Sorry!

Be WISE and PATIENT

VOIGT PATENTS LTD.

THESE ARE IN STOCK

The Radio Designer's Handbook, edited by F. Langford Smith, 10s. 6d., postage 6d. Radio Engineering, by F. E. Terman, 30s., postage 7d.

The Radio Laboratory Handbook, by M. G. Scroggie, 12s. 6d., postage 4d. The "Wireless World" Valve Data, 2s., postage 2d.

Practical Wireless Service Manual, by F. J. Camm, 8s. 6d., postage 4d. The Superheterodyne Receiver, by A. T. Witts, 6s., postage 3d.

Short Wave Wireless Communication, by Ladner and Stoner, 35s., postage 7d. Thermionic Valve Circuits, by E. Williams, 12s. 6d., postage 4d.

Electronic Equipment and Accessories, by R. C. Walker, 25s., postage 7d. American Midgets, by J. Bull, 2s. 6d., postage 2d.

Radar—Radiolocation Simply Explained, by R. W. Hallows, 7s. 6d., postage 3d.

WE HAVE THE FINEST STOCK OF BRITISH AND AMERICAN RADIO BOOKS. WRITE OR CALL FOR COMPLETE LIST.

THE MODERN BOOK CO.

(Dept. W.17), 19-21, PRAED STREET, LONDON, W.2.

COPPER wire, cotton covered, 1/4lb reels, 18, 20, 22, 24g, 1/6; 26, 28g, 1/3; 30, 32g, 2/-; 34g, 2/3; enamelled, same prices, including 36g, 2/3; 38, 40g, 2/6; silk-covered, 16g, 1 lb. 5/-; 18g, 1 lb. 7/-; 22g, 1/4 lb. 2/6 2oz reels, 24, 26, 28g, 1/6; 30, 32, 34, 36g, 1/9; 38, 40g, 2/-; 42g, 2/3; laminated bakelite panels, 1/2in thick, 6in x 4in, 1/3; 6in x 6in, 1/9; 8in x 6in, 2/3; 10in x 6in, 2/9; 10in x 8in, 3/6; 12in x 8in, 4/-; ditto, 1/2in thick, same sizes, 10d, 1/2, 1/6, 1/10, 2/4, 2/8; polished ebonite panels, 1/2in thick, sizes as above, 1/9, 2/9, 3/6, 4/6, 6/-, 7/-; B.A. screws, gross useful sizes, 2/6; ditto, nuts, 2/6 gr; assorted gross screws and nuts, 2/8; brass washers, 1/6 gr; fibre washers, 1/6 gr; assorted soldering tags, 2/- gr; assorted small eyelets and rivets, 1/3 gr; finest quality stranded and single push-back wire, 12yds 2/3; resin cored solder, 1/4 lb 1/-; new ex-G.P.O. hand telephones with microphone, switch and cord, 12/6; Ultra sensitive single earphone, 5/6; lead-in tubes, 4in 9d; 6in, 1/-; 9in, 1/4; all postage extra; trans. supplied.—Post Radio Supplies, 33, Borne Gdns., London, E.4. [6374

MISCELLANEOUS

HAND MADE walnut radiogram cabinet for sale; £20.—Box 4224. [6418

37 "W.W." to June, 46; what offers? 1/- per wire 1.3, 4.39, 17.8, 39, 1.40, 8.40, 2.43.—Box 3455. [6257

TOROIDAL winding machine for sale, suitable toroids 3/4in to 1 1/2 in/d incl. motor; offers over £125.—Box 3396. [6210

TIME Recorders.—Write for particulars.—Gledhill-Brook Time Recorders, Ltd., 84, Empire Works, Huddersfield. [2419

LARGE walnut cabinet especially made for autochanger; near £12.—35, Colebrooke Ave., West Baling, Middlesex. [6430

SHOWCARDS, price tickets, gummed price labels, etc. samples & details free.—Gayler & Hall, 21 Regent St., Southall, Bou. 3529

"SPARKS" data sheets offer the widest range of tested and guaranteed designs, in full-size data sheet form, obtainable in this country.

TINY Two, just released, a 2-valve all-dry self-contained portable, med. waves. DESIGNED for individual listening to local stations on speaker, size 5 1/2 x 5 1/2 x 5 1/4 in. 18-volt HT: 2/6.

THREE-valve all-dry portable, m/l waves. 9x6x4in, a most popular set; 2/6. Send a stamp for full list (W).

"SPARKS" Data Sheets (W), 9, Phoebe Rd., Brockley, S.E.4. Tel. Lee Green 0220. [6509

CHASSIS and panels in aluminium form C 3/9 each, immediate delivery, any size plain or punched for valve holders, etc.—Mead, 13, Bence Lane, Darton, Barnsley. [6180

ELECTRIC open and tubular heaters, etc., supplied to stores and shops.—Write, Matthias Rivlin, 69, Albion St., Leeds. [5947

"W.W." sale 33 copies, 1/6 each, '41 to '45; wanted, Nov. and Dec. '39, May, 40, May, July to Sept. Dec., '41, Feb., '42, Jan., '43, Sept., '46.—Laws, 335, Millhouses Lane, Sheffield, 11. [6391

400,000yds P.V.C. fabric covered steoving grades E.F.C. sizes I.D. 75mm to 8mm colour, yellow, red, black, blue, green; offers wanted for part or whole parcel.—Phone South-end-on-Sea 49491 Extension 124, or write E. K. Cole, Ltd. [6201

IDEAS mean money!—If you have an idea, I we can help you to make the most of it; write at once for full information on the technical, legal and financial services we offer to inventors.—Technico-Legal Services Bureau, 55, Romney St., Westminster, S W 1 [4948

BANDPASS filter for distortion measurements, etc., 800-1,000 cps., 600 ohms, inputs up to 50 watts; £10/10.—A.E. Co., Ltd., 163, Holland Park Ave., London, W.11.

MATHEW Bros. offer very large quantity brand new, Tiny Tim 12v 20 amp petrol charging sets, in maker's boxes; £25 each, plus 10/- carriage; reduction for quantities.

MATBRO Works, Sandy Lane North, Wallington, Tel. Wallington 4950. [6341

"WIRELESS World" bound, indexed, 18 vols, 1925 to 1933, excellent condition; Ferranti transformers, OPM3c, OPM5c, Class "B" AF15c, OPM16c; Darwin cobalt steel speaker, magnet type F.C., Ref. M.1806; offers.—Stevenson, Pendley Manor, Tring, Herts. [6504

"WIRELESS World," vols. 12, 13, 22 to 26; "Experimental Wireless," vols 1 to 3; "Television To-day," Newnes, vols 1 and 2, all bound and as new; "Wireless Telephony Broadcasting," Dowsett, 2 vols., unbound; "Wireless World," 1942, Jan. Feb. Mar. missing 1943 and '44 complete, 1945 complete, less Nov.; "Practical Wireless," 1942 and '43, Aug. missing, 1944 complete, 1945, Sept., Oct., Nov., Dec. missing; what offers?—Box 4387. [6477

And Now

THE GRAMOPHONE REPRODUCER

An amplifier chassis using single 6L6. Output 6 watts for 3, 8, 15 ohm speakers suit crystal or magnetic pick-ups.

WIRED READY FOR USE. 6 GNS.

Other equipments, AC/18, AC/24, AD/9. A range of some fifty transformers. Maintenance spares of every description. If we have not hitherto numbered you amongst our customers—the loss has been ours and, we think, yours too.

A bold statement perhaps! Will you let us prove it? Send 6d. in stamps for our illustrated catalogue, which describes our extensive stocks.

GENERAL LAMINATION PRODUCTS, LTD. WINDER HOUSE, BROADWAY, BEXLEYHEATH.

THIS Does these

ACCURATELY and QUICKLY Chassis, Brackets, Shrouds, Condensers and Transformer clips—Steel or Aluminium. Five sizes—1 1/2" to 3". Full particulars from: A. A. TOOLS, (W), 197a, WHITEFOUR ROAD, ASHTON-UNDER-LYNE

V 55 R COMMUNICATION RECEIVER An All-British Designed and Modified Ex-R.A.F. 1155 Superheterodyne

9 Valves. 5 Switched Bands 3 1/2 Watts Output A.V.C. B.F.O. FULLY TROPICALISED A Receiver for Commercial, Amateur, or Overseas Listener. EARLY DELIVERY. Write RADIOVISION (LEICESTER) LTD. 58-60 RUTLAND STREET, LEICESTER, ENG.

**R**OTARY transformers, 12volts to 50 input, output 275volts, 110ma and dc inputs 50/80ma simultaneously, ideal for P.A. or mobile transmitters; bargain, £31/7/6 each, carriage extra; tough rubber 5-core flexible cable, 7d. per yard; 50mfd 12volt tubular electrolytics, 11d. each; 0.5mfd 450volts tubular paper—Austin Mills, Ltd., Lower Farns, Stockport. [5432]

**WANTED, EXCHANGE, ETC.**  
WANTED, Radiolab workshop testing set. —Box 4184. [6321]

WANTED, radiogram cabinet, any style.—Particulars to Box 3037. [6171]

WANTED, metal cabinets, as supplied with R115 receiver.—Box 4404. [6501]

**L**IC. amateur would be glad of circuit of TR9.—BM/BJKYV, London. [6272]

**W**TD, "W.W." Dec. & May, '46.—Phone Norman, Burgh Heath 338. [6324]

**W**TD, magnetic wire recorder, in good cond.—Full details & price to Box 4120.

**T**UNING condensers, 0.0006mfd single gang, state quantity available & price.—Box 4204.

**S**ERVICE sheets required, all makes.—Condition and price to Box 3407. [6236]

**W**TD, "W.W.s." Jan., 1937-Dec., 1938.—L'Anresse, Hayne Rd., Beckenham, Kent.

**S**ERVICE sheets wanted urgently, all makes, any number.—S.L.D., 18, York Gr., S.E.13.

**W**TD, "P.W.", '42 to '46; offers.—64, Westleigh Park, Bristol, 4. [6276]

**S**ERVICE sheets, all makes from 1930.—Condition and price to Box 1860. [5855]

**G**OODMAN'S infinite-baffle speaker wanted.—Cranbourne Rd., Manchester, 21.

**W**ANTED, Voigt 4ft. straight horn.—De tails to Brewer, Radio, Ebbw Vale.

**W**ANTED, 12A7.—Write Little, Rose Cottage, Burton, Christchurch, Hants.

**W**ANTED, approx. 1/2hp 230 volt 50c ac motor.—Instone, Tivoli Pl., Cheltenham.

**W**ANTED, good set of service sheets, all makes; state details, price.—Box 4456.

**T**ELFVISON, offers or part exchange test gear, Leica, radiogram, car.—Box 4193.

**W**ANTED, Hallicater's Sky Traveller portable communications receiver.—Particulars to Box 3522. [6290]

**W**ANTED, inductor dynamic loudspeaker.—Details and price to Bennett, 1, Manor Drive, London, N.14. [6350]

**A**DVERTISER wishes to consult American radio handbooks from 1938 onwards, particularly Rider.—Box 4397. [6486]

**W**ANTED, 12A7 valve.—Flt. Sgt. Hodgson, R.A.F. Photo. Section, Nuneham Park, Nuneham Courtenay, Oxon. [6516]

**W**TD, beat frequency oscillator, cathode ray oscilloscope, disc recording machine. Send details & price to Box 3454. [6256]

**W**ANTED, bandpass and detector iron cored tuning pack, with circuit connections.—Humpidge, Ilambrook, Bristol. [6521]

**W**E offer cash for good modern communication and all-wave receivers.—A.C.S. Radio, 44, Widmore Rd., Bromley, Kent.

**W**TD, for cash, Quality meters, Westons, Avos, etc. cond. unimportant; exchanges, sales, repairs.—BCM/METERS, London, W.C.1.

**W**ANTED, Universal A.C./D.C. auto record changer in any cond.—Parties, Ramsden, 25 Highfield Chase, Basingstoke, Hants.

**W**ANTED for export, immediate and continuous supplies of portable wireless receiving sets, dry batteries for same and torch batteries.—Quilliam Products, 22, High St., Kingston-on-Thames. [6312]

**W**ANTED, offers from small radio manufacturers of supplies of small radio receiving sets, A.C./D.C., for export, to cost about £8/10, growing big business probable.—Write, in confidence, to Box 496, c/o Pools, Aldwych House, London, W.C.2. [6369]

**G**. W. SMITH & Co. (RADIO) Ltd., require the following: new or second-hand radio receivers and radiograms; all classes of radio test equipment; highest cash prices paid.

**G**. W. SMITH & Co. (RADIO) Ltd., 2, Cecil Rd., Southgate, London, N.14. Tel. Enterprise 5463. [5116]

**W**E buy for cash, new, used, radio, electrical equipment, all types; especially wanted, radios, radiograms, test equipment, motors, chargers, recording gear, etc.—If you want to sell at the maximum price, call, write or phone to University Radio, Ltd., 22, Lisle St., Leicester Sq., W.C.2. Ger. 4447.

**I** WANT to light the Neon lighting on a West End cinema. Machinery must necessarily be run on non-ratified or easily obtainable fuel.—Write Box B 468, c/o Street's, 110, Old Broad St., E.C.2. [6390]

**REPAIRS AND SERVICE**

**M**AINS transformers rewound, new transformers to any specification.

**M**OTOR rewinds and complete overhauls; first class workmanship, fully guaranteed.

**F. M. ELECTRIC Co., Ltd., Potter, Bldgs., Warsop Gate, Nottingham. Est. 1917. Tel. 3855.**

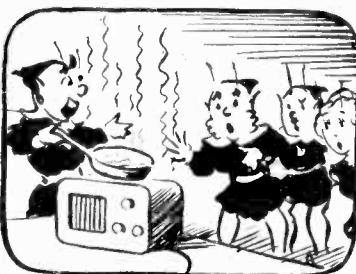

**THE "FLUXITE QUINS" AT WORK**

"You're the craziest fool that I've met. That's no stove! It's a radio set!"  
Grinned Ol. "But its heat Cooks the bacon a treat, Get rFLUXITE, Short circuit I bet."

See that FLUXITE is always by you—in the house—garage—workshop—wherever speedy soldering is needed. Used for over 30 years in Government works and by leading engineers and manufacturers. Of all Ironmongers—in tins, 10d., 1/6 & 3/-.

Ask to see the FLUXITE POCKET BLOW LAMP, price 2/6.

**TO CYCLISTS!** Your wheels will NOT keep round and true unless the spokes are tied with fine wire at the crossings AND SOLDERED. This makes a much stronger wheel. It's simple—with FLUXITE—but IMPORTANT.

The FLUXITE GUN puts FLUXITE where you want it by a simple pressure. Price 1/6, or filled, 2/6.



**ALL MECHANICS WILL HAVE FLUXITE IT SIMPLIFIES ALL SOLDERING**

Write for Book on the ART OF "SOFT" SOLDERING and for Leaflets on CASE-HARDENING STEEL and TEMPERING TOOLS with FLUXITE. Price 1d. each.

**FLUXITE LTD.** (Dept. W.W.), Bermondsey Street, S.E.1

**M**AINS transformer rewound and constructed to any specification; prompt delivery.—Brown, 3, Bede Burn Rd., Jarrow. [3460]

**W**E magnetize P.M. speaker units for the trade, large or small quantities, present delivery within 7 days; consult us with your magnetising problems.

**A. J. PRATT & SONS, Ltd., 7, Woodbridge St., London, E.C.1. [6419]**

**L**OUdspEAKER repairs, British, American, any make; moderate prices.—Sinclair Speakers, 12, Pembroke St., London, N.1. Terminus 4355. [3308]

**T**RANSFORMERS rewound, television E.H.T. a speciality, all types O/P; pick-up bobbins, etc.; prompt service.—North-West Electrical Co., 36, Rosslyn Hill, N.W.3. [6248]

**R**EWINDS and conversions to mains and output transformers, fields, etc., from 4/6; pp equipment a speciality.—N.L. Rewinds, 4, Brecknock Rd., N.7. Tel. Arnold 3390. [6283]

**E**LECTRICAL measuring instruments skillfully repaired and recalibrated, immediate delivery.—Electrical Instrument Repair Service, 329, Kilburn Lane, London, W.9.

**R**EPAIRS to moving coil speaker, cones, R coils fitted, field rewound or altered; speaker transformers, clock coils rewound, guaranteed satisfaction, prompt service.

**L.S. REPAIR SERVICE, 49, Trinity Rd., Upper Tooting, London, S.W.17. [4819]**

**S**ERVICE with a Smile.—Repairers of all types of British and American receivers; coil rewinds; American valves, spares, line cord.—F.R.I., Ltd., 22, Howland St., W.1. Museum 5675. [1575]

**S**TURDY rewinds, mains transformers, S chokes and fields; we give prompt delivery and guarantee satisfaction; 14 years' experience; prices on request.—Sturdy Electric Co. Ltd., Devon, Newcastle-on-Tyne. [4316]

**L**OUdspEAKER repairs.—Our repairs are renowned for quality jobs and satisfaction, at keen competitive prices.—Send yours to L. Cottenham, loudspeaker repair factory, 113, Whetley Lane, Bradford, Yorks. [6387]

**L**OUdspEAKER repairs, any make, reasonable prices, prompt delivery, to the trade and quality fans; 25 years' combined experience with Rola, Magnavox, Goodmans, Celestion.—Sound Service Radio, 80, Richmond Rd., Kingston-on-Thames Kin. 8008. [4977]

**24**-HOUR service, 6 months' guarantee, any transformer rewind, mains outputs and i.f.s., etc., all types of new transf., etc., supplied to specification; business heading or service card for trade prices.—Majestic Winding Co., 180, Windham Rd., Bournemouth.

**R**EWINDS, mains transformers, speaker field coils, chokes, high grade workmanship, 7 day delivery; new transformers constructed to customers' specification, singly or in quantities.—Metropolitan Radio Service Co., 1021, Finchley Rd., N.W.11. Speedwell 3000. [3719]

**L**OUdspEAKER repairs.—A.W.F. give prompt service on most types of loudspeakers and horn units, at reasonable charges, to the trade.—Don't write, send complete speakers and horn units only to A.W.F. Radio Products, Borough Mills, Bradford, Yorks. Tel. 11926. [5455]

**R**EWINDS, mains transformers, layer wound wax impregnated, O/P transformers, chokes, fields, clock coils, pick-ups, fractional hp motors, competitive prices; prompt delivery; guaranteed work.—W. Groves, Manufacturing Electrical Engineer, 154, Icknield Port Rd., Birmingham, 16. [4547]

**A**LL makes and kinds of electrical and radio measuring instruments repaired by skilled technicians, A.I.D. approved; all work quoted by return without charge. Also for sale, large variety of voltmeters, ammeters, milli-ammeters, 2in and 2 1/2in dial, reconditioned ex-Air Ministry stock.—C. Gerler, Dept. D., 29-31, Cowcross St., E.C.1. Tel. Cle 6783. [6205]

**N**ATIONAL RADIO SERVICE & TELEVISION Co., Radio and Television Service Engineers.—Immediate service, any district. Television components from stock, rewinds to transformers from 15/-; loudspeaker cones, speech coils, etc. supplied and fitted. British and American components and valves. Enquiries invited for contract trade service.—40 Northiam, Woodside Park, Finchley, N.12. Hillside 7076. [6004]

**T**RANSFORMER rewinds, trans. replacement coils, machine layer wound on bakelite former, interleaved, impregnated and clearly marked; rewinds, £1, standard windings to 70watts, coils 15/6; extra secondaries and larger types pro rata; new transformers or chokes to specification singly or in quantity; trade list on application; delivery by return of post most types; state model and iron sizes when ordering coils, pick-up coils, O/P trans, etc., rewound or replaced; fully guaranteed.—Radio Services, Field St. Works, Blackpool. R.T.R.A. Service members. Ph. 1250

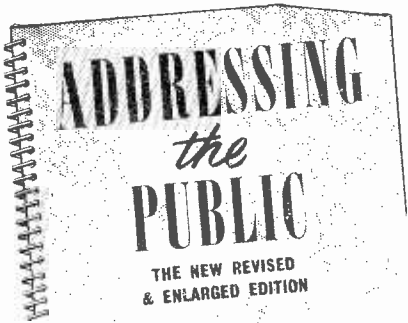

**the fundamentals of  
PUBLIC ADDRESS TECHNIQUE  
FOR RADIO ENGINEERS**

Devoted exclusively to public address, this handbook deals with the technical and practical problems confronting the public address engineer. Contents include:—Specifications — Distortion — Frequency Response — Gain, etc. — Loudspeaker Location — Feedback — Echo — Time Delay — Masking — Reflection — Wind Effect, etc. — Loudspeaker Matching — Phasing — Impedances — 120v. Line etc. — Microphone Lines — Mixing, etc. Pickup Correction — Filtering, etc. — Operating — Speech Boosting — Background Music, etc. — Appendix Tables, etc.

**PRICE  
3/6  
POST FREE**



MANUFACTURING CO. LTD., HUNTINGDON TEL. 361

**MIDLAND INSTRUMENT CO.**

LEWCO'S copper instrument wires, current stock:—Enam. 28-30-32-34-36 swg. Lewmex, 20-22-24-28-29-31-32-33-34 swg. Enam./s.c. 31-35-38 swg. D.C.C. 12-22-24-26 swg. Also resistance wires, and hundreds of other interesting Radio and Electronic Items, Gov. surplus, etc. Lists 6d. with s.a.e.

18, Harborne Park Road, Birmingham, 17  
Tel.: HA 8308 or 2664

**TELE-RADIO (1943) LTD.**

offer readers of this publication a wide range of radio components and accessories.

- SWITCHES.**  
Oak or Yaxley type. All types and combinations made up on the premises.
- CONDENSERS.**  
Twin-gang Midget, screened, 1 1/2 in. x 3 1/2 in., ceramic insulation on stators. 25-25 pf per section, 7/6; 50-50 pf, 8/6; 75-75 pf, 10/6.
- |                                       |      |
|---------------------------------------|------|
| 8 Microfarad T.M.C., 2,000 volt block | 52/6 |
| 4 " " T.M.C.                          | 33/- |
| 2 " " AEROVOX, 1,000 volt             | 5/9  |
| R.C.A. Ceramic button base ...        | 1/6  |
| 813 Ceramic bases ...                 | 12/6 |
| EF50 Ceramic bases ...                | 3/-  |
- POTENTIOMETERS.**  
Midget low noise level potentiometers, 10,000 ohm, 100,000, 500,000 and 2 megohms, 4/6 each. Other values standard sizes with or without switches, 6/6 and 4/6. 6in. Perspex Feeder Spreaders, 6d. each.

Illustrated Catalogue now available. 2/d. Post Free.

**TELE-RADIO (1943) LTD.**

177, Edgware Rd., London, W.2  
Telephone: PADDINGTON 6116.

**DEGALLIER'S, Ltd.**—Service with a guarantee; if you cannot get your receiver serviced, let American specialists do the job: first-class workmanship only; specialising in Air-King, Belmont, Challenger, Delco, Detrola, de Wald, Emerson, Ferguson, Garot, Halli-crafter, Hammerlund, Lucille, McMurdo Silver, Midwest, Majestic, Pilot, Philco, Scott, Spar-ton, Stromberg Carlson, R.C.A., etc., also any British or Continental set; due to lack of accommodation our service branches are still dispersed; therefore apply for forwarding in-structions before despatching sets; s.a.e. with all enquiries.  
**DEGALLIER'S, Ltd.**, 9, Westbourne Court, London, W.2. [6410]

**WORK WANTED.**  
**WOOD-WORKING** factory req. repetition work, wireless cabinets, etc.—Box 4200.  
**RADIOGRAMS** and wireless cabinets made to order for home and export.—Box 3033.  
**ARTIST-DESIGNER**, experienced in modern interior design, seeks contact with manu-facturers interested in new ideas for cabinet design.—Box 4406. [6513]

**LABELS**—For the Rig plastic, cardboard, or metal engraved to your requirements; various colours.—Details, "Supervox" Servis, 29, Market St., Watford, Herts. [5856]  
**ALL** types receivers, amplifiers, etc., re-paired, designed, rebuilt; special bench set up for repair of midget sets; work guaran-teeed; enq.—H. V. Beck, 49, St. Quintin Ave., W.10. [6289]

**FOXWINDERS**, 74A, East Hill, Wands-worth, S.W.18, are now able to quote you for your light press work, blank form or pierc-ings, also castpan work, milling, turning and guillotining. [6211a]

**MECHANICAL** drawings and tracings of light mechanical or electrical apparatus or instruments, toys, models, and castings, pre-pared from samples, sketches, descriptions and worn prints; multi-view assembly drawings of mechanisms with details of components; suit-able for Patent Office; all work undertaken in strict confidence.—Enquiries to Box 3408. [6289]

**T**he name to note for all kinds of radio and electrical metal work to specification, modern rustproof, all shapes and sizes under-taken, and for tropical use; components and sub-assemblies executed to meet recognised wiring and material standards; consultation, advice without obligation.—Write Dept. 23, Sea Rescue Equipment, Ltd., Chiltern Works, Clarendon Rd Watford, Herts. [5977]

**SITUATIONS VACANT**  
**KINGSTON-UPON-HULL EDUCATION AUTHORITY**, Municipal Technical Col-lege.

**REQUIRED.** As soon as possible, a full-time assistant radio instructor for the Municipal Technical College; candidates must hold a first class P.M.G. certificate in wireless telegraphy; practical experience with modern radio equipment (marine and aircraft), in-cluding radar, will be an advantage. **SALARY** will be in accordance with the Burn-ham Scale of salaries for teachers in technical colleges, 1945, and increments will, in ap-pro-priate cases, be allowed for industrial ex-perience.

**FURTHER** particulars and application forms (which must be returned within 14 days of the date of this issue) can be obtained on receipt of a stamped, addressed, foolscap en-velope, from the Director of Education, Edu-cation Offices, Guildhall, Kingston-upon-Hull.

**RADIO** service engineer required (S.W. London suburb), must have extensive experience on domestic receivers; good situa-tion for right man.—Box 4165. [6313]

**EXPERIENCED** radio service engineer re-quired; permanency.—Killbourn, Abing-don, Berks. [6519]

**SERVICE** engineer required for Bromley, Kent.—Write, stating age, experience, and salary required, Box 4191. [6544]

**REQUIRED**, service engineer with television experience; permanency to good man; £6/10 p.w. exp.—Dines, High St., Harlow, Ex.

**RADIO** and television engineer required.—Write, stating salary and experience, re-lis. Pickett & Sons, 258, Cowley Rd., Oxford.

**B**onnet manufacturers in London area; write, giving details exp. & salary.—Box 4203.

**COMPETENT** wireless engineer for inside servicing, capable to work without super- vision; very good wages for the right man.— Box 4166. [6314]

**EXPERIENCED** hearing-aid engineer-mech- anic reqd. with some knowledge of pro-duction; good salary & prospects; write, giving full particulars in confidence.—Box 4119.

**L**OUDSPEAKER production, South of England firm, 14 miles from London, re-quires capable designer and production man-ager, must be experienced, very good pros-pects.—Box 4305 [6424]

**PITMAN'S  
Radio Books**

**THE SUPERHETERODYNE RECEIVER**

By Alfred T. Witts, A.M.I.E.E.  
An outstanding book by an experienced practical man, giving expert practical information on construction and main-tenance. Now in its sixth edition, it should be studied by everyone interest- ing in up-to-date receiver design and con-struction. 6/- net.

**MODERN RADIO COMMUNICATION VOL. I**

By J. H. Reyner, B.Sc. (Hons.), A.C.G.I., D.I.C., A.M.I.E.E., M.Inst. R.E. This work is a model of clear exposition, and throws light on all branches of modern radio theory. With Vol. II (Advanced) now reprinting, it provides a complete course in radio engineering and covers the syllabus of the City and Guilds examinations as well as the P.M.G. Certificate. 7/6 net.

PITMAN, Parker St., Kingsway, London, W.C.2

**TRANSFORMERS & COILS TO SPECIFICATION.**

MANUFACTURED OR REWOUND.

**STANLEY CATTELL LTD.**

9-11 East Street, TORQUAY, Devon  
Phone: Torquay 2162.

**HILL & CHURCHILL LTD**

**BOOKSELLERS  
SWANAGE, DORSET**

- Available from stock —
- |   |      |
|---|------|
| Scowen—Electric Wave Filters                                | 15/- |
| Weller—Radio Technology                                     | 21/- |
| Zepler—Technique of Radio Design                            | 21/- |
| Reyner—Testing Radio Sets                                   | 15/- |
| Harvey—H.F. Thermionic Tubes                                | 18/- |
| Ladner & Stoner—Short Wave Wire- less Communication         | 35/- |
| Zworykin & Others—Electron Optics & the Electron Microscope | 60/- |
| Kemp—Theory of A.C. Wave Forms                              | 17/6 |

We have a large selection of English and American Books on RADIO and TELECOMMUNICATION.

CATALOGUE ON APPLICATION

**A**PLICATIONS are invited from suitably qualified men for post as radio repair mechanic instructor at a Government training centre in Slough area.

**A**PPlicants must be skilled craftsmen and in addition to having served an apprenticeship must have had at least five years' experience in their craft.

**E**VIDENCE of having attended a technical institute for instruction and of having obtained a final certificate in a radio course will normally be required. Experience in lecturing, while not essential, will be an advantage.

**I**MPERIAL annual salary is £385, which is inclusive of Civil Service Consolidated allowance. Provision is made for periodical increases in salary to a maximum of £455 per annum.

**S**ALARY will be paid in respect of eighteen days' annual leave and for all public holidays and, subject to Civil Service conditions, for period of sickness. The hours of duty will be about 44 per week, exclusive of meal breaks. **T**HE successful applicant must be prepared to take a short course of training at the Ministry of Labour Training College at Letchworth at the Department's expense.

**A**PPPLICATION should be made to the nearest Employment Exchange. [6372]

**A**PLICATIONS are invited for the following appointments in an engineering precision manufacturing electro/mechanical precision instruments on a batch basis:—

(a) Production engineer to take charge of a department comprising process engineering, jig and tool design, rate fixing, and tool manufacture; salary grade, £900-£1,200 per annum.

(b) Production engineer, to determine and control production methods (machining and assembly) on small precision electro-mechanical instruments; salary grade, £650-£850 per annum.

(c) Production engineer, to determine and control production methods on precision electrical components (e.g., coils, chokes, transformers, motors, generators, etc.); salary grade, £750-£1,000 per annum.

**T**he Company is situated in the London area and employs about 1,500 people. A Pension Scheme is available, and the above appointments are eligible for participation after 12 months' service with the company.

Apply by letter to Box AC.14336, Samson Clarks, 57-61, Mortimer St., London, W.1.

**R**ADIO engineers.—Large firm in London area requires experienced radio set designers, previous experience essential.—Write, stating age, exp. & salary reqd., Box 4209.

**R**ADIO service engineer with wide experience. All makes; state qualifications, references, salary req., service dept. excellently equipped.—Gerry, 36, Bank St., Newquay, Cornwall.

**E**XPERIENCED radio-television engineer req. by progressive firm, Thames Valley; good wages and prospects; permanent position.—Write fullest possible details to Box 4190.

**V**ORTEXION, Ltd., are now in the position to offer immediate employment to keen wiremen in their P.A. Equipment division.—Apply 257-261, The Broadway, Wimbledon, S.W.19. [6373]

**S**ENIOR radio service engineer required for retail service dept., fully conversant all domestic receivers, television experience an asset, practical pre-war experience essential.—Box 4212. [6405]

**S**ALES management; a deputy sales manager is required by an engineering company, near London, manufacturing and selling precision instruments; essential qualifications are:—

(1) Engineering training, experience and qualifications.

(2) Experience in controlling a technical sales department and service department operating on a budgetary control basis.

(3) Previous personal association with Government technical and production branches.

(4) Experience in export procedure and foreign markets.

(5) Age 30-40 years.

The initial salary is between £1,000 and £1,500 per annum, and, subject to satisfactory service, the successful candidate will be eligible for a higher executive appointment.

Apply by letter to Box AC.14337, Samson Clark, 57-61, Mortimer St., London, W.1.

**R**ADIO service engineer required for N. West Coast town; take full control modern service dept.; good wages and excellent prospects to right man.—Qualifications, age, wage, etc., to Box 4469. [6527]

**R**ESearch department of British Insulated Callender's Cables, Ltd., require immediately experienced designer for telephone and radio frequency cables accessories; responsible and progressive post.—Applications, giving all particulars, to Staff Officer, Prescot, Lancs. [6436]

**FIRST "HOME" RELEASE  
of the "Q-MAX"  
SHORT WAVE ALL-DRY FOUR**

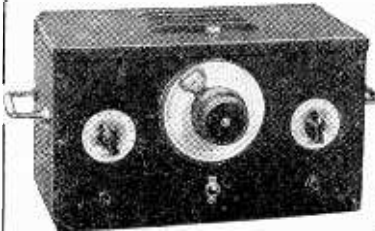

- Range 11-250 metres.
- Maximum Sensitivity.
- Single Tuning Dial.

**PRICE 12 GNS.**

(Coils, Speaker and Battery: extra)

**THE "Q-MAX"  
SUPER SLOW MOTION DIAL**

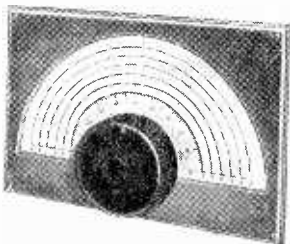

**MODEL SMBD**

A very high class precision slow motion unit for communication type equipment, with combined direct and slow motion drive (50-1).

**PRICE 66/-.**

**Junior Model, 8-1 . . . . . 15/6**

**"Q-MAX" CHASSIS CUTTER**



Ends all your tiresome scraping and drilling; cuts holes easily, cleanly and quickly.

For Octal holes 1 1/8" 10/6

Post 9d. extra.

**TRADE AND EXPORT ENQUIRIES  
INVITED.**

Send 6d. for Illustrated Catalogue "W"

**BERRY'S  
(SHORT WAVE) LTD.**

**25, HIGH HOLBORN, LONDON, W.C.1**

(Opp. Chancery Lane)

'Phone: HOLborn 6231

**R**EQUIRED, first-class draughtsmen and tracers for radio and electrical engineers in London area; previous experience essential.—Write, stating age, experience and salary required, to Box 4208. [6380]

**W**ORKS manager for small firm of transformer and electrical manufacturers; must have the necessary technical knowledge of design and production; chance for energetic applicant with new and progressive company; West London area.—Box 4455. [6518]

**S**ENIOR and junior radio engineers with experience of electrical and mechanical development factory production of domestic receivers; salary according to qualifications and experience.—Apply to Personnel Manager, Airmerc Ltd., Walsworth Rd., Perivale. [6186]

**D**ESIGNER draughtsman required; experienced in development of light electro-mechanical apparatus and preferably with a knowledge of tele-communications laboratory gear; accustomed to workshop practice and production problems; capable of working on own initiative.

**A**PPLY, stating age, experience, salary, etc., to Muirhead & Co., Ltd., Elmers End, Beckenham, Kent. [6376]

**S**ENIOR development engineer required by instrument company engaged in tele-communications, industrial and medical measuring equipment; good degree or equivalent essential; some years experience in comparable work including radio; age at least 28 years; salary £590-£760 p.a.—Box 4197. [6356]

**D**RAUGHTSMAN designer required, good opportunities for man who has original ideas and experience in design for mass production to combine the two in the design of household and radio equipment in London area; applicants should write, stating age, experience and salary reqd.—Apply Box 4202

**R**EQUIRED, first class designer draughtsman with experience of radio and electrical equipment and the design of chassis, press tools, sub-assemblers, etc.; mechanical knowledge desirable; radio and electrical engineers in London area.—Write, stating age, experience and salary required, to Box 4207.

**A** VACANCY is open for designer-draughtsman with company engaged on radio, electro-mech. development; applicants need not have been employed in this capacity before, providing they are keen on post-war planning, would suit ex-Service personnel. R.A.F. preferred.—Apply to Chief Designer Radio Mech., Box 4407. [6514]

**J**UNIOR executive to take charge of life test department, radio valve factory at Sunderland, Inter. B.Sc. or H.N.C. standard with knowledge of electronics essential, experience in valve industry desirable.—Full particulars of education, experience and salary in first instance, to Personnel Department, Cosmos Manu. Co., Ltd., Brimsdown, Enfield.

**L**ARGE firm in London area has vacancies in its development department for test gear engineers; several years' experience in the design of electronic equipment is essential; test gear assistants with experience in wiring and assembly of electronic equipment are also required.—Write, stating age, experience and salary required, to Box 4182. [6310]

**R**ADIO assembly charge hand required. Thorough knowledge of component part and line assembly, also coil wave winding machine setting; accustomed to control and training of female labour; good prospects and permanency for right man in well-established factory, S.E. London area.—Write, stating age, experience and salary required, to Box 4192.

**T**HE BRITISH SCIENTIFIC INSTRUMENT RESEARCH ASSOCIATION has vacancies in their new laboratories for scientists with first class academic and professional qualifications. The following appointments will shortly be made in the electrical instruments and electronic departments located in the outskirts of South-East London:—

**A. PHYSICIST** with at least 4 to 5 years' experience in electronic instruments or electronic circuits.

**B. PHYSICIST** or engineer with at least 4 to 5 years' experience in electrical (non-electronic) or magnetic instruments.

**C. JUNIOR** physicists or engineers with some experience in the field of electrical or electronic instrument technology.

The appointment will be made in the first instance in the Scientific Officer grade: £300-£550 and carry F.S.S.U. benefits after a probationary period.

**A**PPPLICATION in writing only giving full details to Director of Research and Secretary, B.S.I.R.A., 26, Russell Sq., W.C.1. [6409]

**W**ORKS manager required for London factory of old established manufacturers of electrical and radio components; position calls for energy, initiative and drive; give full details of qualifications, past and present employment, age and salary required; applicant should have held position carrying salary of £1,000 p.a.—Box 4194. [6352]

## WEYMOUTH 3-wave COIL PACK

19-50m., 200-550m., 800-2,000m.  
Superhet type for 465 kc. I.F.T.

Completely aligned in  
Standard receiver.

Wiring diagram supplied

**38/6**  
each

WEYMOUTH RADIO MFG. CO. LTD.,  
CRESCENT ST., WEYMOUTH, DORSET

## A.C.S. RADIO

SPECIALISTS IN AMATEUR AND EXPERI-  
MENTAL SHORT-WAVE EQUIPMENT,  
Communications Receivers, Television, High quality  
Amplifiers, Speakers, Aerials, Receiving and Transmitting  
Valves and Meters, etc.

List "W" free on request in —  
A.C.S. RADIO, 44, Widmore Rd., BROMLEY,  
Kent. Phone: RAV 0156.

## PHOTO-ELECTRIC CELLS

Se/Te on gold-alloy, super-sensitive to light,  
gas-filled, permanent, operate relay direct  
or with Valve Amplifier, perfect reproduction  
of Speech and Music from sound track of  
films; large tube 3 1/2 in. from glass top to valve  
pin base, 1 in. diam., 38/-; same type 2 1/2 in. long,  
35/-; small tube 2 in. from top to terminal  
base, 3/4 in. diam., 30/-; miniature cell, glass  
top to cap base, 1 in. overall, 3/4 in. diam., thin  
flex leads, 28/-; all cells operate on 40-100  
volts. Connections diagrams free.

**OPTICAL SYSTEM FOR SOUND FILM**  
Operates from any car headlight bulb. Our  
patent external adjustment of the interior  
light-slit permits setting of a fine light-film  
from 1/4 to 2 thousandth inch, for scanning film  
sound track direct into Photo-cell, nickel tube  
2 in. long, 3/4 in. diam., 3 in. focus, 55/- . Full  
instructions free.

GEFA INSTRUMENTS, 38a, York Street,  
TWICKENHAM, Middx. PO Postgrove 6597

## LONDEX for RELAYS

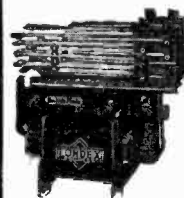

for A.C. and D.C.

2 VA Coil consumption  
from 2 to 600  
volts and tested to  
2000 volts, Aerial  
Changeover Relays,  
Mercury Relays, Meas-  
uring Relays and  
Time Delay Relays

Multiple contact  
Relay LF.

Ask for leaflet  
205/VVV

**LONDEX LTD**

MANUFACTURERS OF RELAYS

207, ANERLEY ROAD LONDON S.E.20

SYDNEY

6258-9

**R**ADIO development engineers required for  
mass production of domestic receivers;  
minimum technical qualifications being  
Standard of City and Guilds Finals, and for  
senior position applicants must have actual  
factory experience of putting into production  
laboratory designed models.—Apply Personnel  
Manager, Airmec, Ltd., Wadsworth Rd., Perivale.  
Other applications will not be enter-  
tained. [6388]

**C**INEMATOGRAPH engineer required to  
take charge of installation and service  
for important distributors of sound film ap-  
paratus, Middle East; attractive salary on  
3-year contract can be offered to really first-  
class man with good technical knowledge and  
thorough experience of sound film equipment.  
—Write, full details experience, qualifications,  
age and present salary, to Box 4186. [6330]

**L**ARGE radio manufacturing firm in S.W.  
London area have vacancies for technical  
supervisors (electrical assistant foremen);  
must have passed grade III of City and Guilds  
in radio or equivalent, plus good practical  
experience in the industry.—Reply, giving full  
details and stating salary required, to Box  
345, L.P.E., 110, St. Martin's Lane, W.C.2,  
quoting reference Z1. [6432]

**T**HE CIVIL SERVICE COMMISSIONERS  
announce that a special competition will  
be held for appointments as Assistant Engi-  
neer (new style) male—in the Post Office  
Engineering Department, and Assistant Traffic  
Superintendent in the Telephone Department  
of the General Post Office. Approximately 100  
vacancies in each grade will be filled by ex-  
aminations spread over a period of two or  
three years.

**C**CANDIDATES must have been born on or  
after the 2nd August, 1915, and have attained  
the age of 18 by the 1st January of the year  
in which they compete. Allowance will be  
made for service in H.M. Forces prior to 3rd  
September, 1939.

**M**EN only are eligible to compete for appoint-  
ment as Assistant Engineer (new style).

**T**HE salary scales are as follows:—  
ASSISTANT Engineer (new style): London,  
£280 rising by annual increments of £20 to  
£580; provinces, £265 rising by annual in-  
crements of £20 to £560 (including consolida-  
tion addition).

**A**SSISTANT Traffic Superintendent: Men,  
London, £190 rising by annual increments  
of £18 to £465; provinces, £180 rising by  
annual increments of £18 to £435. Women,  
London, £190 rising by annual increments  
of £12 to £375; provinces, £180 rising by  
annual increments of £12 to £345 (including  
consolidation addition).

**T**HERE will be prospects of promotion to  
higher grades.

**C**CANDIDATES now serving in H.M. Forces  
must send in their application forms in time  
to reach the Civil Service Commission not  
later than six months after the completion of  
their service. All other candidates must send  
them in by 1st April, 1947, except that for  
candidates who are under 18 years old on the  
1st April, 1947, the latest date for sending  
in the form is the 1st January following their  
18th birthday.

**C**OPIES of the Regulations and Forms of  
Application may be obtained from the Secre-  
tary, Civil Service Commission, Burlington  
Gardens, London, W.1, or from the Chief  
Officer, Civil Service Commission, at the fol-  
lowing addresses, quoting No. 1679:—

INDIA.—10, Underhill Lane, Delhi.  
EGYPT.—8, Sharia Tolombat, Garden City,  
Cairo.

ITALY.—c/o G.H.Q., C.M.F.  
GERMANY.—c/o 2nd Echelon. G.H.Q.,  
B.A.O.R. [6517]

**T**HE services of one or two engineers re-  
quired, who have been employed during  
the war years in the development of radar  
ground and airborne equipment, and pre-  
ferably with some knowledge of Gee; the situa-  
tion is in the Manchester area and the salary  
up to £600 p.a. according to qualifications.—  
Please reply, giving full details of age, pre-war  
and wartime experience, and when available,  
to Box 4189. [6337]

**W**IRELESS operators/mechanics required  
for shore duties with large oil company  
operating in Middle East areas; applicants  
must possess 1st class P.M.G. (sea-going) Cer-  
tificate, have sound fundamental knowledge  
of radio telegraphy, and experience in main-  
tenance; age limit 40; salary £360 per annum  
for first three-year contract (progressively re-  
newable), plus free quarters/messing, medical  
attention and allowances between the range  
of £120 for the bachelor or married man with-  
out children to £238 for the man with three  
children under the age of 18; married appli-  
cants only considered if prepared to live  
singly for first three years abroad.—Replies  
to Box 1394, c/o Charles Barker & Sons, Ltd.,  
31, Budge Row, London, E.C.4. [6420]

## HARTLEY - TURNER HIGHEST FIDELITY SPEAKER

We much regret that persistent advances in  
raw materials compel us to raise the price of  
our new speaker to £9 on and after Dec. 1st,  
1946. Even so it is remarkable value for money,  
for those who have already bought it say it is  
far too cheap. This does not affect our policy,  
which is always to provide the highest possible  
quality at the lowest possible cost. The new  
price is an honest reflection of the cost of  
manufacture. The new reproduction is an  
honest reflection of the original performance.  
Send for the descriptive leaflet now.

MODEL 215—£9.

High-grade Push-Pull O.P. Transformer 55/-

**H. A. HARTLEY CO. LTD.**  
132 HAMMERSMITH RD., LONDON, W.6

## REWINDS

Armatures, Fields, Transformers, Pick-  
ups, Vacuum Cleaners, Gram Motors,  
Speakers Refitted New Cones & Speech  
Coils.

All Guaranteed and promptly executed  
Valves, B.V.A. and American, good stocks. Send  
stamped addressed envelope for list of Radio Spares,  
and C.O.D. Service.

261-3-5, Lichfield Road,  
**A.D.S. Co.** ASTON, BIRMINGHAM, 6

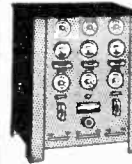

## BATTERY CHARGERS and TRICKLE CHARGERS

Trouble-free Chargers fitted with select-  
ion all-metal rectification. Good allow-  
ance on your old Charger. Thirty  
years experience behind every Runbaken  
product. Booklet R.15 describing 13  
Models on request.

**RUNBAKEN MANCHESTER**

## MIDGET I.F.s.



Giving  
Maximum Gain  
and Selectivity

Standard Frequency  
465 kc/s

Other Frequencies  
to order

Dimensions:  
1" diam. x 1 1/2" high

Price **9/6** each

## MONOCHORD RADIO

235, Streatham Road, London, S.W.16

## POST-WAR TELEVISION

The advance in Radio Technique offers unlimited  
opportunities of high pay and secure posts for those  
Radio Engineers who have had the foresight to become  
technically qualified. How you can do this quickly  
and easily in your spare time is fully explained in our  
unique handbook.

Full details are given of A.M.I.E.E., A.M.Brit.I.R.E.  
City & Guilds Exams., and particulars of up-to-date  
courses in Wireless Engineering, Radio Servicing, Short  
Waves, Television, Mathematics, etc., etc.

We Guarantee "NO PASS—NO FEE"

Prepare for to-morrow's opportunities and post-war  
competition by sending for your copy of this very  
informative 112-page guide NOW—FREE.

**BRITISH INSTITUTE OF ENGINEERING  
TECHNOLOGY (Dept. 388)**

17, Stratford Place, London, W.1

# Bulls can send it

	£ s. d.
AVOMINOR UNIVERSAL, 22 range Test meter	8 10 0
BULGIN LF33 Interval Transformer	7 6
CELESTION speaker, 8in. P.M. w. Trans.	1 14 0
DAGOLE Droppers, 3amp., 5/6 ; 2 amp.	4 6
ERIE Cabinets 96, 1 w. or 48, 1 w. Resist	1 4 0
FERRANTI Univ. Circuit Testers	8 16 6
GOODMAN 34 Loudspeakers	1 10 0
HIVAC XL, XD, XH, midget valves	12 10
IONIC Filkodic, ohms Calculators	6 6
J.B. Filament Transformers, 6.3 v.	10 6
KIT—Electroplating Home Outfit	1 9 6
LEXINGTON Pick-up, faithful recording	6 5
MULTICORE Ersa 3 core Solder	4 10
NUTS, Bolts and Washers, 3 gross ass.	6 6
OUTPUT Transformers, Midget	6 0
PITMAN Radio Books (84 p. list) from	3 0
QUIXO Battery Testers, Leg-type meter	2 12 6
RAYMART Var. Cond. VC250X Standard	6 3
SERVOL Contact Cleaner, 1 pint tin	5 0
T.M.C. Electrolytic, all values from	1 9
UNIVERSAL Multipliers B.P.L., new model	8 17 6
VARLEY Dry Accufactors, 20 A.H.	16 3
WEYMOUTH 3-wave Coilpack w. Diagram	1 18 6
XMAS GIFT, Elec. Motor Model Kit	8 11
YANKEE Tubes (state number) from	6 0
ZEAL to you	

ALL VALVES, Brit. and Am., from 5/10.  
**STOP PRESS.** Success "Efficiency" Books arrived.  
**ORDER** (also items not listed) COD. Under 10/- C.W.O.  
**COMPONENTS:** full range of tested quality in stock.  
**BOOKS:** Comprehensive Radio List available.  
**METERS:** AVO., B.P.L., Ferranti, Sitam, etc.  
**SHORTWAVE:** All Raymart Products stocked.  
**SPECIAL:** E.C.R.30 Tube, £3/3-.  
**MAILING LIST:** Send Address on P.C. in Capitals.  
**OVERSEAS** orders safely packed and fully insured.  
 Those Who Serve, or Have Served Special Attention.

**FURTHER OFFERS.**

LINECORD, 3.6Ω 3 way, 106 ft. 2 way.	8
HOLDERS, all types from	8 9
GAUGES, Kit for Speaker Centring	2 3
FABBU, glass, for Speakers, 1 sq. foot	2 4
AERIAL WIRE, P.V.C. 50 feet	2 11
DIALS, 6v x 5in. All Wave Stations	3 0
CHOKES, H.F., all waves	3 6
VOLUME Controls, w/s.w., 5/3 ; less sw	3 6
SLEEVEING, assorted, dozen	4 0
LEVELS (Spirit), aluminum case	4 6
CEMENT, Cellulose, 1 pint tin	5 0
PILOT LAMP HOLDERS, ass. dozen	5 6
B.A. SOCKET SET, Senior, 14/6 ; Junior	6 6
HYDROMETER, non-break model	6 6
ERIE Col. Code Ind. and 12 ass. Resist.	8 0
VARLEY Thermal Delay Switch	10 0
VARLEY Class B Input Transformer	15 0
AMMETERS: Rotex 30 a., 19/6 ; 0-6 a.	15 0
RAWPLUG Workshop Outfit	15 0
VARLEY L.F. Choke 5.5 Hs. 50 Ω 250 mA.	16 0
VARLEY Quiescent P.P. Input Transf.	18 0
ELIMINATORS w. Metal Rectifier	1 17 4
VIDOR Elec. Cooker, w. Oven	1 19 6
RAWPLUG Mechanical Hammer	2 12 6
AVOMINOR D.C. Model	4 4 0
ELIMINATORS, w. Trickle Charger	4 15 0
TRANS-Receiver, w. Power Pack	15 0 0
AVO Model 7, A.C./D.C. 50 Range	19 10 0
B.P.L. Signal Generator, 100 Kc/s. 30 Mc/s.	21 0 0

C.O.D. or Remit with Order and Postage.  
**J. BULL & SONS**  
 (W.W.), 246, High St., Harlesden, N.W.10

## A.F. WINDING & RE-WINDING

TRANSFORMERS, CHOKES, AND FIELD COILS

### SOUTHERN TRADE SERVICES,

297/299, HIGH ST., CROYDON  
 Tel.: 4870

Manufacturers of  
**"TELECRAFT" PRODUCTS**

**DESIGNER, jig and tool.**—Applications invited for highly responsible position in large engineering company, North London area; applicants must have considerable pre-war experience with firms of repute; should be familiar with modern mass production practice, and must be competent to supervise design of tooling for wide range of products.—Applications must be made in writing, giving full details age, previous experience and positions held, with salaries, to Box 4384.

**SENIOR** assistant to patent manager required by long established radio and television manufacturers; qualifications must include a degree or equivalent and a sound knowledge, both practical and technical, of radio and electronics with a real interest in technical correspondence and specifications; salary between £250 and £700 p.a. according to qualifications and experience.—Apply, giving necessary particulars, to Box 4198. [6358]

**ASSISTANT** required for work in patent department of long established radio and television manufacturers; applicant's qualifications must include a good technical knowledge of radio and electronics, preferably a degree or equivalent, a definite aptitude for and interest in new inventions and patent procedure; salary according to qualifications and experience; age not above 35 years.—Apply, giving necessary particulars, to Box 4199.

**SECOND** assistant radio engineer required by the Government of Iraq for the Basrah Port Directorate for a tour of one year in the first instance. Salary Iraq dinars 40 a month plus a high cost of living allowance of between Iraq dinars 11½ and Iraq dinars 14½ a month, according to number of dependants (Iraq dinar 1=£1). Provident Fund. Free passages. Candidates must be Associate Members of the British Institute of Radio Engineers or hold the City and Guilds of London Institute's Diploma in Radio Communications (Part III), and the Postmaster General's First Class Certificate in Radio Communication. They must have had at least five years' experience of radio engineering work including not less than two years on radio transmitters.—Apply at once by letter, stating age, whether married or single, and full particulars of qualifications and experience, and mentioning this paper, to the Crown Agents for the Colonies, 4, Millbank, London, S.W.1, quoting M/N/14691, on both letter and envelope. [6457]

**SITUATIONS WANTED**  
**RADAR** officer, 37, released December, requires post, London area, administrative, technical or instructional.—Box 4382. [6465]  
**ASS. Brit. I.R.E., C. & G.** final in radio, com. and tech. elec., spkgs. fluent French, age 26, seeks post anywhere.—Box 4398. [6487]  
**DEVELOPMENT** engineer, experienced in the development and design of modern communication equipment & navigational aids. ENGAGED for the past 18 years by well-known concern, present position involves administrative work and control over laboratory of a number of engineers; A.M.I.E.E., married, age 38; any responsible engineering position offering scope for initiative considered, even if outside the above experience; own car available; salary exceeding £950.—Box 4205. [6368]

**CHARTERED** secretary-accountant, age 32, seeks progressive post offering opportunities for utilising technical knowledge and enthusiasm for radio in conjunction with personal services.—Box 4400. [6490]  
**RADIO** service engineer seeks change, television experience, capable take charge service dept., permanent progressive post with high-class business, South or West or overseas.—Further particulars Box 4335. [6441]

**RADIO** engineer (26), 7 years' experience domestic and industrial radio and electronics, including publicity and administrative work, desires post North London or Herts area, technical, administrative or sales; available Jan.—Box 4307. [6428]

**FIRST** class radio and television fault finder, accustomed to developing modifications to eliminate production snags, requires responsible post in South England with manufacturer, or will consider dealer requiring service manager.—Box 4187. [6332]

**R. SIGNALS** technical officer, 33, ex-foreman of signals and Class 1 radio mechanic, released Jan., '47, 18 yrs. experience telecommunications, radio servicing, P.A. design and installation, requires suitable position East Kent or Medway districts.—Box 4183. [6320]

**RADIO** officer (Dutch), 40 years of age, full technical radio knowledge, specialised in radio valves and transmitters, experience with radar, good organiser, wishes to take up position as representative, or agency for a good British firm; demob. begin 1947; references.—Randall, 6, Cadman Rd., E. Southsea, Portsmouth. [6248]

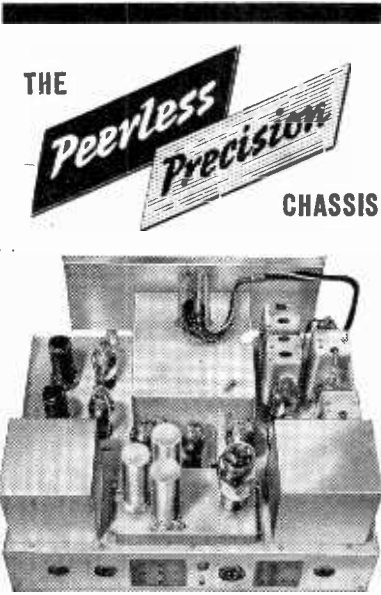

## Some "High Lights" from the impressive Specification of the PEERLESS TYPE 1546 CHASSIS

- Designed by a group of the original "Back-room Boys" of Government Laboratory fame.
- Employs 15 valves in a circuit combining precision communications facilities with High-Fidelity Broadcast reception technique.
- Has a frequency range from Television to Long Waves.
- Is completely "Tropicalised" to H.M. Government approved standards.

Write for detailed specification and photograph. Trade and Export enquiries invited.

**TELEMECHANICS LIMITED**  
 374 KENSINGTON HIGH STREET,  
 LONDON, W.14

Phone: WEStern 1221. Cables: Teleset, London.

## MORSE CODE TRAINING



There are Candier Morse Code Courses for **BEGINNERS AND OPERATORS.**

Send for this Free "BOOK OF FACTS" It gives full details concerning all Courses.

**THE CANDLER SYSTEM CO.,**  
 (Room 55W), 121 Kingsway, London, W.C.2  
 Candler System Co., Denver, Colorado, U.S.A.

# 111 Pages

## PACKED WITH INTEREST

The most comprehensive Radio and Electronic Component Catalogue ever offered is yours for the asking. All lines are by well-known manufacturers including a complete valve range—No job clearance lines whatsoever.

SEND TO-DAY

BRIGHTON TRADE SERVICES LTD.

63, London Road, Brighton 1, Sussex.  
Tel.: Brighton 1555.

### METAL CABINETS

Now delivering ex stock, latest design Steel Cabinets with louvered back and sides, hinged lid. Complete with Aluminium Front Panel size 10" by 10 1/2" and finished in Black Ripple. Supplied packed flat for safe transit, can be assembled in a few minutes. Price only 60/- each, plus 2/6 packing and postage. Aluminium Chassis fit, size 17" by 10" by 2" deep, 6/- (if ordered separately, plus 1/- packing and postage). Aluminium Panel Brackets 7" by 7" 1/- per pair (separately, 9d. extra packing and postage).

Please include P.O. or M.O. with orders for despatch same day, and give name and address in block letters. Smaller sizes will be announced later, also metal handles.

Do try to VISIT us—we're the top of the list for components!

WIRELESS SUPPLIES UNLIMITED  
264-266, OLD CHRISTCHURCH ROAD,  
BOURNEMOUTH, HANTS.

## COVENTRY RADIO

COMPONENT SPECIALISTS since 1925

- CONDENSERS, .01, .05 and .1 mfd..... 9d.
- CONDENSERS, 25 asst. Valves..... 12/6
- TOGGLE SWITCHES, Q.M.B. Toggle S.P..... 2/-
- ROTARY SWITCHES, 4 Pole, 3-way 3/6
- VALVE HOLDERS, Octal, 6d. Per Gross..... 45/-

Latest List of Hundreds of Components and 5-valve Circuit, Price 3d.

COVENTRY RADIO,  
191, DUNSTABLE ROAD, LUTON.

## ENGINEERING OPPORTUNITIES



This unique handbook shows the easy way to secure A.M.I.Mech.E., A.M.Brit.I.R.E., A.M.I.E.E., City and Guilds, etc.

**WE GUARANTEE—“NO PASS—NO FEE.”**

Details are given of over 150 Diploma courses in all branches of Civil, Mech., Elec., Motor, Aero., Radio, Television and Production Engineering, Tracing, Guiding, Govt. Employment, R.A.F. Maths., Matriculation, etc.

Think of the future and send for your copy at once—FREE.

B. I.E.T., 387, SHAKESPEARE HOUSE,  
17, STRATFORD PLACE, LONDON, W.1.

RADIO serviceman, A.M.I.E.T., 24, 6 years' servicing experience, ex-R.A.F. w/mech., excellent refs., drive, seeks post, any area, where use made of good education, initiative, & technical ability; own test gear.—Box 4210.

CHIEF draughtsman with many years' experience on experimental and production design of domestic appliances, radio equipment, measuring instruments, light mechanisms, etc., seeks position in London.—Box 4117.

R.A.F. signals officer, ex-apprentice, 18 years' experience, desires progressive post, high commencing salary not essential, own car, distinguished pass officers' signal course, fully conversant modern technique, including radar, television, F.M., willing to qualify as required, available March, 1947.—Box 4356.

EX-C.P.O. telegraphist R.N., practical experience in radar, UH/F and L/F, 7 years' Western Electric installation engineer, 10 years' B.B.C. maintenance, desires change, preferably in receiver design, but willing to consider any practical H/F or L/F job offering not less than £500 p.a.—Box 4401.

PATENTS, ETC.  
THE proprietor of British Patent No. 556320, entitled Improvements in Television System and Method, offers same for licence or otherwise to ensure its practical working in Great Britain.—Inquiries to Singer, Ehlert, Stern & Carlberg, Chrysler Bldg., New York, 17, N.Y., U.S.A. [6408]

THE Trade Mark Magnavox No. 411317, registered in Class 2 (Schedule 11), in respect of electrical sound-amplifying devices, loud speaking telephones, marine telephones, aircraft telephones, desk telephones, audio-frequency amplifying cabinets, control boxes for loud speaking telephones, loud speaking transmitters, junction boxes, anti-noise telephones and master ringers for marine telephone equipment, all being goods included in Class 2, was assigned on the 2nd October, 1946, by Celestion Limited, of Celestion Works, London Rd., Kingston-on-Thames, Surrey, to The Magnavox Co., of Fort Wayne, Indiana, U.S.A., without the goodwill of the business in which it was then in use. [6447]

PATENT AGENTS  
A. E. HILL, chartered patent agent, 27, Chancery Lane, London, W.C.2. [4368]

### BRITISH NATIONAL RADIO SCHOOL.

PRACTICAL training in radio physics. A three months' laboratory course is now available at the British National Radio School, a long established and highly successful institution specialising in converting "operators" and "mechanics" into radio engineers. Correspondence courses in radar, radio and television. Ask for details of our unique "Four Year Plan" leading to Brit. J.R.E. and I.E.E. examinations with five City and Guilds certificates as interim rewards.—Studies Director, B.N.R.S., 66, Adiscombe Rd., Croydon, Sy.

ENGINEERING careers and qualifications.  
BOTH Government and industry have announced and emphasised that young men with technical knowledge and qualifications must receive every chance to rise to the highest positions within their capacity, in post-war engineering and allied industry. write to-day for The Engineer's Guide to Success"—200 courses free—which shows you how you can become A.M.I.E.E., A.M.I.A.E., A.M.I.Mech.E., A.F.R.Ae.S., etc., and covers all branches in radio, automobile, mechanical, electrical, production, aeronautical, etc.

THE Technological Institute of Great Britain, 82, Temple Bar House, London, E.C.4. [4918]

RADIO training.—P.M.G. exams, and I.E.E. Diploma; prospectus free.—Technical College, Hull [0611]

RADIO Engineering, Television and Wireless Telegraphy, comprehensive postal course of instruction.—Apply British School of Telegraphy, Ltd., 179, Clapham Rd., London, S.W.9 (Est'd, 1906) Also instruction at school in being for H.M. Merchant Navy and R.A.F. [9249]

ENGINEERING Opportunities," free 112-page guide to training for A.M.I.Mech.E., A.M.I.E.E., and all branches of engineering and building; full of advice for expert or novice; write for free copy and make your peacetime future secure.—B.I.E.T. (Dept. 387B), 17, Stratford Place, London, W.1. [6271]

THE Tuitionary Board of the Institute of Practical Radio Engineers have available home study courses covering elementary, theoretical, mathematical, practical and laboratory tuition in radio and television engineering; the text is suitable coaching matter for I.P.R.E. Service entry and pre-war rates are moderate.—The Syllabus of Instructional Text may be obtained post free from Secretary, 20, Fairfield Rd., Crouch End, N.8.

## QUARTZ CRYSTALS.

MAXIMUM ACTIVITY.  
PRECISION BUILT UNITS.  
GUARANTEED ACCURACY.  
OSCILLATORS—RESONATORS,  
LABORATORY TYPES.  
AMATEUR RANGES.  
MANUFACTURERS SUPPLIED.

## BROOKES CRYSTALS LTD.

(ESTABLISHED 1929)  
51/53 GREENWICH CHURCH ST., LONDON, S.E.10  
PHONE: GREENWICH 1828

## RADIO BATTERY TESTER

Use "Quixo" method of battery testing.  
Reliable results. Guaranteed.  
Send for interesting leaflet  
R115 on battery testing



RUNBAKEN - MANCHESTER.

## BEETHOVEN ELECTRIC EQUIPMENT LIMITED

Beethoven RADIO  
BEETHOVEN WORKS, CHASE ROAD, LONDON, N.W.10

## MATRICULATION

brings Success & Security

Whatever your age, you can now study for the all-important Matriculation Examination at home on "NO PASS—NO FEE" terms. "MATRIC" is the accepted passport to all careers, and opens up opportunities which would otherwise be completely closed to you. Ensure the success and security of you and yours through post war difficulties by writing for our valuable "Guide to Matriculation" immediately—FREE

B.T.I. (Dept. 114)  
356, Oxford Street, London, W.1.

## WARD ROTARY CONVERTERS

For Radio, Neon Signs, Television, Fluorescent Lighting, X-ray, Cinema Equipment and innumerable other applications

We also manufacture:—  
Petrol Electric Generating Plants, H.T. Generators, D.C. Motors, Frequency Changers, etc., up to 25 K.V.A.

## CHAS. F. WARD

37, WHITE POST LANE, HACKNEY WICK, E.9  
Phone: Amhurst 1393



**A** NEW course now available deals with practical radio servicing and introduces new and hitherto unpublished methods; unsuitable for beginners; send for free details to: BCM/CIRCUIT, London, W.C.1. [5735]

**TECHNICAL TRAINING.**  
**A** M.I.E.E., City and Guilds, etc., on "No Pass—No Fee" terms; over 95% successes; for full details of modern courses in all branches of electrical technology send for our 112-page handbook, free and post free.—B.I.E.T. (Dept. 388A), 17, Stratford Place, London, W.1. [6270]

**AGENCIES**

**HOLLAND.**—Long established firm of repute, importers and wholesalers in radio components in Holland, wishes to contact first-class manufacturers of all kinds of radio components. TUBULAR, mica, variable and electrolytic condensers.

**LOUDSPEAKERS,** resistances, volume controls, switches, coils, padders, trimmers, measure instruments, etc.—Box 3390. [6200]

**CHARTERED** electrical engineer, specialist in electronics and electrical measurements, is going to U.S.A. for several years, returning to U.K. on brief visits frequently; good contacts with agents and U.S. Patent Office and secretarial facilities are available. Firms of repute wishing to establish or maintain technical liaison are invited to communicate with advertiser.—Box 3524. [6292]

**BUSINESSES FOR SALE OR WANTED.**

**R**ETAIL radio business, est. 11 years in south coast town in Kent, sales £200 p.w., nett profit £2,000 p.a.; price for goodwill, plant, stock, etc., only £2,500; purchaser can take over from owner; excellent living accom.—Write Box 3402. [6250]

**OLD-ESTABLISHED** electric, radio, cycle business, many direct agencies, in important S. Wales city, long lease, turnover approx. £20,000, for sale, goodwill £2,000 plus stock, fittings, etc., at cost.—Polley, 65, Pen-Y-Dre, Rhuwina, Cardiff. [6506]

**EAST Devon.**—Electrical, radio and cycle business, double-fronted shop, main street position; turnover £3,000 per annum; good living accommodation, 3 double beds, 2 box rooms, bath, 2 rec., kitchen, good storage accommodation, small walled garden, greenhouse; price £5,500 includes goodwill, equipment, and freehold property; stock at valuation.—E. Hayns, 4, Johnson's Place, Exmouth.

**L-R-S**

**AVOMINOR TEST METERS**

A.C./D.C. Universal..... £8 10 0  
D.C..... £4 4 0  
Regd. Post 10d.

**CYLDON ELECTRIC DOOR CHIMES**

Beautifully made. Far more pleasant than buzzer or bell. Front door push operates double chimes, back door only single. Universal model for battery or mains with bell transformer (extra). Postage 10d. £2 9 6

**HIGH-GRADE 15 JEWEL GENTS WRIST WATCHES**

Swiss movement, modern case, best quality leather strap. Regd. Post 9d. £9 14 6

List of Chimes 1d.

ANY OF THE ABOVE SUPPLIED ON EASY TERMS

The LONDON RADIO SUPPLY Co.  
(Est. 1925) BALCOMBE, SUSSEX

**TRANSFORMERS & CHOKES**

To Special requirements 14 days  
High Quality Vacuum Impregnated

**AUSTIN MILLS LTD.**  
LOWER CARRS STOCKPORT

Telephone: STO. 3791 Established 20 years.

**BRITISH SOUND RECORDING ASSOCIATION**

Covers the interests of professional recording engineers—amateur recordists and all interested in high quality reproduction. Details of Information Bureau, meetings, visits, publications and membership application form from:

Hon. Secretary, BCM, BSRA, London, W.C.1.

*Crystal Pick-ups*

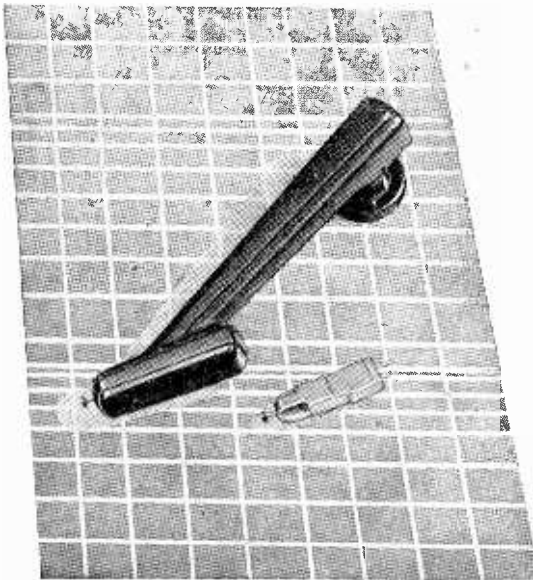

Licensed by Brush Crystals Co., Ltd



Mod. GP-10 is Cosmocord's first post-war Crystal Pick-up.

Resonance-free response from 50-8,000 cps. using commercial steel or permanent needles. Output 1.5 v. at 1,000 cps. Needle pressure 1½ oz. Vibration-free arm movement. Screened lead. List price in Gt. Britain. 35/- plus P.T.



products combine the reliability of Brush crystals with the experience in manufacture and design of COSMOCORD LTD • ENFIELD • MIDDX • ENGLAND  
★ From your Radio Dealer when supplies are more plentiful.



**HIGH VOLTAGE COMPONENTS**

Half Wave Valve Rectifiers, 6,000 volts.....	10/6
4-pin Ceramic Bases for same .....	1/3
.1 MFD 8,000v. working Tubular Condensers ..	12/6
.1 MFD 6,000v. working Square Can Type .....	8/6
.03 MFD 3,000v. working 3,000v. Test Tubular	5/6
.02 MFD 5,000v. working 10,000v. Test Tubular	6/6
001 MFD 5,000v. working 10,000v. Test Tubular .....	4/6
001 MFD 5,000v. Test Mica-don Flat Mounted ..	2/9
Moving Coil Meter, 3½in. square face, 20,000	
O.P.V. scale calibrated 0-5 kV. and 0-10 kV.	87/6
Moving Coil Meter, 3½in. round face, 1,000	
O.P.V. scale calibrated 0-5 kV.....	35/-
Cash with order or C.O.D. Send stamp for illustrated comprehensive price list.	

V.S. CO., RADIO HOUSE, RUISLIP, MIDDX

**NON-MAGNETIC TURNTABLES**

with  
**STROMBOSCOPIC MARKING**  
An essential accessory for serious  
**PICK-UP DESIGN RESEARCH**

**SOUND SALES LIMITED**

57 St. Martin's Lane, London, W.C.2

Temple Bar 4284

Works: Farnham, Surrey



# Photo-Electric Cells



Manufacturers of over forty different types of Photo-electric cells from standard ranges to "miniatures" and "specials" designed to meet all requirements in industry and the laboratory, with characteristics and physical dimensions over the widest possible range.

- Multiplier cells for amplification of the primary photo current.
- Geiger Muller tubes for Cosmic Ray research and other applications.
- Quartz cells for use with ultra violet radiation.
- Nitrogen Helium Discharge Lamps.

New Brochure and price list now available on application.

**CINEMA - TELEVISION LTD.,**  
INCORPORATING BAIRD TELEVISION LIMITED  
WORSLEY BRIDGE RD., LONDON, S.E.26  
Telephone: Hither Green 4600

Suppliers to ADMIRALTY, MINISTRY OF AIRCRAFT PRODUCTION, MINISTRY OF SUPPLY, ARMAMENT RESEARCH, etc. Manufacturers of Scientific Instruments and Photo-electric cells.

**UNIVERSAL COUPLING**



Manufactured from the finest quality material with tropical bakelite insulation, this inexpensive constant velocity coupling incorporates a novel design preventing lost motion due to misalignment of the coupled components.

PRICE 2/9 RETAIL



**JACKSON BROS (LONDON) LIMITED**  
KINGSWAY · WADDON · SURREY  
TELEPHONE: CROYDON 2754-5 TELEGRAMS: WALFILCO. PHONE. LONDON



## MOVING-COIL MICROPHONES

BRIT. PAT. No. 566137

The outstanding performance of these scientifically designed and precision-built instruments makes them the choice of discriminating experts. Write Dept. W. W. 12 for full descriptive leaflet.

**LUSTRAPHONE LTD.,** 84, BELSIZE LANE, LONDON, N.W.3.  
Telephone: HAMstead 5389 and 5515.



## UNIT OSCILLOSCOPE

A NEW CONCEPTION OF INDUSTRIAL NEEDS

Interchangeable Amplifiers and Time Bases with a wide range of accessories cover every application. No loose wires, no unwanted controls, no complex switches, but standard snap-on units give rigid assembly with tailor-made performance.

**LYDIATE ASH LABORATORIES**  
RESEARCH AND DEVELOPMENT ENGINEERS  
**Nr. BROMSGROVE**  
Telephone: RUBY 168/169



## THERMAL DELAY SWITCHES

*Protect Your Radio Equipment*

4 VOLT · 5 VOLT · 6.3 VOLT HEATERS

**OLIVER PELL CONTROL LTD**

Telephone - WOOLWICH 1422  
CAMBRIDGE ROW WOOLWICH S.E.18

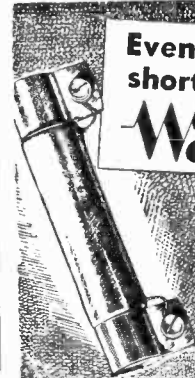

Even a double load doesn't shorten the life of a

## Welwyn Resistor

"No property of the resistance presented any apparent alteration." Such is the independent report after testing a Welwyn Vitreous Resistor for 670 hours at continuous double load. (Normal load gives working temperature of 450°C.) Sizes:—1 w. to 300 w.

New Trade catalogue available.  
**WELWYN ELECTRICAL LABS. LTD**  
Welwyn Garden City, Herts. Pho: Wel. Gar. 3816



Wise...

foolish?



Research Engineers and Chemists, Designers and Draughtsmen, picked for their superior knowledge and technical skill, are continually engaged in efforts to improve the design and efficiency of the finest Capacitors made. Working methodically and with patient persistence, they are equipped with costly apparatus and backed by modern manufacturing methods.

All this costs money, but . . . .

It is an investment that manifests itself in T.C.C. Capacitors. Long-term economy and long-time trouble-free service are characteristic features of the T.C.C. products. Inevitably they cost a little more, but in the

long run they cost more than a little less, for once they are fixed T.C.C. Capacitors will last for years. Superior design and high-grade materials *must* produce better Capacitors . . . . It *must* pay you to buy the best!

# TCC

## CAPACITORS

THE TELEGRAPH CONDENSER CO. LTD.

RADIO DIVISION

NORTH ACTON · LONDON · W. 3

TELEPHONE: ACORN 0061



HL.41.DD	
Filament Voltage	4.0V
Filament Current	0.65A
Maximum Anode Voltage	250V
Mutual Conductance	2.5mA/V
Amplification Factor	30



HL.133.DD	
Filament Voltage	13.0V
Filament Current	0.2A
Maximum Anode Voltage	250V
Mutual Conductance	2.5mA/V
Amplification Factor	32

The HL.41.DD, designed for use in A.C. Mains Receivers and the HL.133.DD, in AC/DC Receivers, are Double-diode Triode valves with two separate diodes and a triode on a common cathode sleeve.

They are recommended for performing the simultaneous functions of Detection, A.V.C and Amplification. When used as an L.F Amplifier the triode section may be either Resistance — Capacity or Transformer Coupled.

# MAZDA

## RADIO VALVES AND CATHODE RAY TUBES

THE EDISON SWAN ELECTRIC CO. LTD., 155, CHARING CROSS ROAD, LONDON, W.C.2

R.M.4